



489 GENERATOR MANAGEMENT RELAY[®] Instruction Manual

489 Firmware Revision: 32H150A8.000
489PC Software Revision: 1.50
Manual P/N: 1601-0071-E8 (GEK-106290)
Copyright © 2002 GE Power Management



808754E3.CDR

GE Power Management

215 Anderson Avenue, Markham, Ontario
Canada L6E 1B3
Tel: (905) 294-6222 Fax: (905) 294-8512
Internet: <http://www.GEindustrial.com/pm>



Manufactured under an
ISO9001 Registered system.

TABLE OF CONTENTS

1. INTRODUCTION	1.1 OVERVIEW
	1.1.1 DESCRIPTION..... 1-1
	1.1.2 ORDER INFORMATION..... 1-3
	1.1.3 OTHER ACCESSORIES..... 1-3
	1.2 SPECIFICATIONS
	1.2.1 SPECIFICATIONS 1-4
2. INSTALLATION	2.1 MECHANICAL
	2.1.1 DESCRIPTION..... 2-1
	2.1.2 PRODUCT IDENTIFICATION..... 2-2
	2.1.3 INSTALLATION..... 2-3
	2.1.4 UNIT WITHDRAWAL AND INSERTION 2-3
	2.1.5 TERMINAL LOCATIONS 2-5
	2.2 ELECTRICAL
	2.2.1 TYPICAL WIRING DIAGRAM 2-7
	2.2.2 TYPICAL WIRING 2-8
	2.2.3 CONTROL POWER 2-9
	2.2.4 PHASE CURRENT INPUTS 2-9
	2.2.5 GROUND CURRENT INPUT 2-10
	2.2.6 VOLTAGE INPUTS 2-11
	2.2.7 DIGITAL INPUTS 2-11
	2.2.8 ANALOG INPUTS 2-11
	2.2.9 ANALOG OUTPUTS 2-12
	2.2.10 RTD SENSOR CONNECTIONS 2-12
	2.2.11 OUTPUT RELAYS 2-13
	2.2.12 IRIG-B 2-13
	2.2.13 RS485 COMMUNICATIONS PORTS 2-14
	2.2.14 DIELECTRIC STRENGTH TESTING 2-15
3. OPERATION	3.1 OVERVIEW
	3.1.1 489 FACEPLATE 3-1
	3.1.2 DISPLAY 3-2
	3.1.3 LED INDICATORS 3-2
	3.1.4 RS232 PROGRAM PORT 3-3
	3.1.5 KEYPAD..... 3-4
	3.1.6 ENTERING ALPHANUMERIC TEXT 3-4
	3.1.7 ENTERING +/- SIGNS 3-4
	3.2 SETPOINT ENTRY
	3.2.1 PROCEDURE 3-5
4. SETPOINT PROGRAMMING	4.1 OVERVIEW
	4.1.1 TRIPS / ALARMS / CONTROL FEATURES DEFINED 4-1
	4.1.2 RELAY ASSIGNMENT PRACTICES 4-1
	4.1.3 DUAL SETPOINTS 4-2
	4.1.4 SETPOINT MESSAGE MAP..... 4-2
	4.2 S1 489 SETUP
	4.2.1 PASSCODE 4-3
	4.2.2 PREFERENCES 4-3
	4.2.3 SERIAL PORTS 4-4
	4.2.4 REAL TIME CLOCK..... 4-5
	4.2.5 DEFAULT MESSAGES..... 4-5
	4.2.6 MESSAGE SCRATCHPAD..... 4-6
	4.2.7 CLEAR DATA..... 4-7
	4.3 S2 SYSTEM SETUP
	4.3.1 CURRENT SENSING 4-8

TABLE OF CONTENTS

4.3.2	VOLTAGE SENSING.....	4-8
4.3.3	GENERATOR PARAMETERS	4-9
4.3.4	SERIAL START/STOP INITIATION.....	4-9
4.4 S3 DIGITAL INPUTS		
4.4.1	DESCRIPTION	4-10
4.4.2	ACCESS SWITCH.....	4-10
4.4.3	BREAKER STATUS	4-10
4.4.4	GENERAL INPUT A to G.....	4-11
4.4.5	REMOTE RESET	4-12
4.4.6	TEST INPUT	4-12
4.4.7	THERMAL RESET.....	4-12
4.4.8	DUAL SETPOINTS.....	4-12
4.4.9	SEQUENTIAL TRIP	4-13
4.4.10	FIELD-BREAKER DISCREPANCY	4-14
4.4.11	TACHOMETER.....	4-14
4.4.12	WAVEFORM CAPTURE	4-15
4.4.13	GROUND SWITCH STATUS	4-15
4.5 S4 OUTPUT RELAYS		
4.5.1	DESCRIPTION	4-16
4.5.2	RELAY RESET MODE	4-16
4.6 S5 CURRENT ELEMENTS		
4.6.1	INVERSE TIME OVERCURRENT CURVE CHARACTERISTICS	4-17
4.6.2	OVERCURRENT ALARM.....	4-20
4.6.3	OFFLINE OVERCURRENT	4-20
4.6.4	INADVERTENT ENERGIZATION.....	4-21
4.6.5	VOLTAGE RESTRAINED PHASE OVERCURRENT.....	4-22
4.6.6	NEGATIVE SEQUENCE OVERCURRENT.....	4-23
4.6.7	GROUND OVERCURRENT	4-25
4.6.8	PHASE DIFFERENTIAL	4-26
4.6.9	GROUND DIRECTIONAL.....	4-27
4.6.10	HIGH-SET PHASE OVERCURRENT.....	4-28
4.7 S6 VOLTAGE ELEMENTS		
4.7.1	UNDERVOLTAGE	4-29
4.7.2	OVERVOLTAGE.....	4-30
4.7.3	VOLTS/HERTZ.....	4-31
4.7.4	PHASE REVERSAL	4-32
4.7.5	UNDERFREQUENCY	4-33
4.7.6	OVERFREQUENCY.....	4-34
4.7.7	NEUTRAL OVERVOLTAGE (FUNDAMENTAL).....	4-35
4.7.8	NEUTRAL UNDERVOLTAGE (3RD HARMONIC)	4-36
4.7.9	LOSS OF EXCITATION.....	4-38
4.7.10	DISTANCE ELEMENTS	4-39
4.8 S7 POWER ELEMENTS		
4.8.1	POWER MEASUREMENT CONVENTIONS.....	4-41
4.8.2	REACTIVE POWER	4-42
4.8.3	REVERSE POWER	4-43
4.8.4	LOW FORWARD POWER	4-44
4.9 S8 RTD TEMPERATURE		
4.9.1	RTD TYPES.....	4-45
4.9.2	RTDS 1 TO 6.....	4-46
4.9.3	RTDS 7 TO 10	4-47
4.9.4	RTD 11	4-48
4.9.5	RTD 12	4-49
4.9.6	OPEN RTD SENSOR	4-49
4.9.7	RTD SHORT/LOW TEMPERATURE.....	4-50
4.10 S9 THERMAL MODEL		
4.10.1	489 THERMAL MODEL	4-51
4.10.2	MODEL SETUP	4-52
4.10.3	UNBALANCE BIAS.....	4-61
4.10.4	MACHINE COOLING.....	4-62
4.10.5	HOT/COLD CURVE RATIO.....	4-63
4.10.6	RTD BIAS	4-63
4.10.7	THERMAL ELEMENTS	4-64

TABLE OF CONTENTS

4.11 S10 MONITORING	
4.11.1 TRIP COUNTER	4-65
4.11.2 BREAKER FAILURE	4-65
4.11.3 TRIP COIL MONITOR	4-65
4.11.4 VT FUSE FAILURE	4-66
4.11.5 CURRENT, MW, MVAR, MVA DEMAND	4-67
4.11.6 PULSE OUTPUT	4-69
4.11.7 GENERATOR RUNNING HOUR SETUP	4-69
4.12 S11 ANALOG I/O	
4.12.1 ANALOG OUTPUTS 1 TO 4	4-70
4.12.2 ANALOG INPUTS 1 TO 4	4-71
4.13 489 TESTING	
4.13.1 SIMULATION MODE	4-73
4.13.2 PRE-FAULT SETUP	4-74
4.13.3 FAULT SETUP	4-75
4.13.4 TEST OUTPUT RELAYS	4-75
4.13.5 TEST ANALOG OUTPUT	4-76
4.13.6 COMM PORT MONITOR	4-76
4.13.7 FACTORY SERVICE	4-76

5. ACTUAL VALUES

5.1 OVERVIEW	
5.1.1 ACTUAL VALUES MESSAGES	5-1
5.2 A1 STATUS	
5.2.1 GENERATOR STATUS	5-2
5.2.2 LAST TRIP DATA	5-2
5.2.3 ALARM STATUS	5-3
5.2.4 TRIP PICKUPS	5-5
5.2.5 ALARM PICKUPS	5-8
5.2.6 DIGITAL INPUTS	5-11
5.2.7 REAL TIME CLOCK	5-11
5.3 A2 METERING DATA	
5.3.1 CURRENT METERING	5-12
5.3.2 VOLTAGE METERING	5-13
5.3.3 POWER METERING	5-14
5.3.4 TEMPERATURE	5-15
5.3.5 DEMAND METERING	5-16
5.3.6 ANALOG INPUTS	5-16
5.3.7 SPEED	5-16
5.4 A3 LEARNED DATA	
5.4.1 PARAMETER AVERAGES	5-17
5.4.2 RTD MAXIMUMS	5-17
5.4.3 ANALOG IN MIN/MAX	5-18
5.5 A4 MAINTENANCE	
5.5.1 TRIP COUNTERS	5-19
5.5.2 GENERAL COUNTERS	5-21
5.5.3 TIMERS	5-21
5.6 A5 EVENT RECORDER	
5.6.1 EVENT RECORDER	5-22
5.7 A6 PRODUCT INFO	
5.7.1 489 MODEL INFO	5-25
5.7.2 CALIBRATION INFO	5-25
5.8 DIAGNOSTICS	
5.8.1 DIAGNOSTIC MESSAGES FOR OPERATORS	5-26
5.8.2 FLASH MESSAGES	5-27

6. COMMUNICATIONS

6.1 ELECTRICAL INTERFACE	
6.1.1 ELECTRICAL INTERFACE	6-1

TABLE OF CONTENTS

6.1.2	MODBUS RTU PROTOCOL	6-1
6.1.3	DATA FRAME FORMAT AND DATA RATE	6-1
6.1.4	DATA PACKET FORMAT	6-1
6.1.5	CRC-16 ALGORITHM	6-3
6.1.6	TIMING	6-3
6.2 SUPPORTED MODBUS FUNCTIONS		
6.2.1	OVERVIEW	6-4
6.2.2	FUNCTION CODES 03/04: READ SETPOINTS/ACTUAL VALUES	6-4
6.2.3	FUNCTION CODE 05: EXECUTE OPERATION	6-5
6.2.4	FUNCTION CODE 06: STORE SINGLE SETPOINT	6-5
6.2.5	FUNCTION CODE 07: READ DEVICE STATUS	6-6
6.2.6	FUNCTION CODE 08: LOOPBACK TEST	6-6
6.2.7	FUNCTION CODE 16: STORE MULTIPLE SETPOINTS	6-7
6.2.8	FUNCTION CODE 16: PERFORMING COMMANDS	6-8
6.2.9	ERROR RESPONSES	6-8
6.3 MEMORY MAP		
6.3.1	MEMORY MAP INFORMATION	6-9
6.3.2	USER DEFINABLE MEMORY MAP AREA	6-9
6.3.3	EVENT RECORDER	6-9
6.3.4	WAVEFORM CAPTURE	6-10
6.3.5	DUAL SETPOINTS	6-10
6.3.6	PASSCODE OPERATION	6-10
6.3.7	489 MEMORY MAP	6-11
6.3.8	MEMORY MAP DATA FORMATS	6-40
6.4 DNP COMMUNICATIONS		
6.4.1	DEVICE PROFILE DOCUMENT	6-45
6.4.2	IMPLEMENTATION TABLE	6-47
6.4.3	DEFAULT VARIATIONS	6-48
6.5 DNP POINT LISTS		
6.5.1	BINARY INPUT / BINARY INPUT CHANGE (OBJECTS 01/02)	6-49
6.5.2	BINARY / CONTROL RELAY OUTPUT BLOCK (OBJECTS 10/12)	6-51
6.5.3	BINARY / FROZEN COUNTER (OBJECTS 20/21)	6-52
6.5.4	ANALOG INPUT / INPUT CHANGE (OBJECTS 30/32)	6-53

7. TESTING

7.1 TEST SETUP		
7.1.1	TEST CONTENTS	7-1
7.1.2	SECONDARY INJECTION TEST SETUP	7-2
7.2 HARDWARE FUNCTIONAL TESTING		
7.2.1	OUTPUT CURRENT ACCURACY	7-3
7.2.2	PHASE VOLTAGE INPUT ACCURACY	7-3
7.2.3	GROUND (1A), NEUTRAL AND DIFFERENTIAL CURRENT ACCURACY	7-4
7.2.4	NEUTRAL VOLTAGE (FUNDAMENTAL) ACCURACY	7-4
7.2.5	NEGATIVE SEQUENCE CURRENT ACCURACY	7-5
7.2.6	RTD ACCURACY	7-6
7.2.7	DIGITAL INPUTS AND TRIP COIL SUPERVISION	7-7
7.2.8	ANALOG INPUTS AND OUTPUTS	7-7
7.2.9	OUTPUT RELAYS	7-8
7.3 ADDITIONAL FUNCTIONAL TESTING		
7.3.1	OVERLOAD CURVE TEST	7-9
7.3.2	POWER MEASUREMENT TEST	7-10
7.3.3	REACTIVE POWER TEST	7-11
7.3.4	VOLTAGE PHASE REVERSAL TEST	7-12
7.3.5	INJECTION TEST SETUP #2	7-12
7.3.6	GE POWER MANAGEMENT HGF GROUND ACCURACY TEST	7-13
7.3.7	NEUTRAL VOLTAGE (3RD HARMONIC) ACCURACY TEST	7-13
7.3.8	PHASE DIFFERENTIAL TRIP TEST	7-14
7.3.9	INJECTION TEST SETUP #3	7-15
7.3.10	VOLTAGE RESTRAINED OVERCURRENT TEST	7-16

TABLE OF CONTENTS

8. 489PC SOFTWARE	8.1 INSTALLATION/UPGRADE
	8.1.1 DESCRIPTION..... 8-1
	8.1.2 HARDWARE & SOFTWARE REQUIRMENTS..... 8-1
	8.1.3 CHECKING IF INSTALLATION/UPGRADE IS REQUIRED 8-2
	8.1.4 INSTALLING/UPGRADING 489PC 8-3
	8.2 CONFIGURATION
	8.2.1 STARTUP & COMMUNICATIONS CONFIGURATION 8-4
	8.3 USING 489PC
	8.3.1 SAVING SETPOINTS TO A FILE 8-5
	8.3.2 UPGRADING THE 489 FIRMWARE 8-6
	8.3.3 LOADING SETPOINTS FROM A FILE 8-7
	8.3.4 ENTERING SETPOINTS 8-7
	8.3.5 UPGRADING SETPOINT FILES TO NEW REVISION..... 8-9
	8.3.6 PRINTING SETPOINTS & ACTUAL VALUES 8-9
	8.3.7 TRENDING 8-10
	8.3.8 WAVEFORM CAPTURE 8-12
	8.3.9 PHASORS..... 8-13
	8.3.10 EVENT RECORDER..... 8-14
	8.3.11 TROUBLESHOOTING 8-15
A. COMMISSIONING	A.1 COMMISSIONING
	A.1.1 SETPOINTS SUMMARY A-1
B. APPLICATION NOTES	B.1 STATOR GROUND FAULT PROTECTION
	B.1.1 DESCRIPTION..... B-1
	B.1.2 NEUTRAL OVERVOLTAGE ELEMENT B-1
	B.1.3 GROUND OVERCURRENT ELEMENT B-3
	B.1.4 GROUND DIRECTIONAL ELEMENT B-4
	B.1.5 THIRD HARMONIC VOLTAGE ELEMENT..... B-6
	B.1.6 REFERENCES..... B-6
C. CURVES	C.1 TIME OVERCURRENT CURVES
	C.1.1 ANSI CURVES..... C-1
	C.1.2 DEFINITE TIME CURVE..... C-5
	C.1.3 IAC CURVES C-6
	C.1.4 IEC CURVES C-10
D. CTs	D.1 CURRENT TRANSFORMERS
	D.1.1 GROUND FAULT CTs FOR 50:0.025 A CT D-1
	D.1.2 GROUND FAULT CTs FOR 5 A SECONDARY CT..... D-2
	D.1.3 PHASE CTs D-3
E. WARRANTY	E.1 WARRANTY INFORMATION
	E.1.1 WARRANTY..... E-1
F. APPENDIX F	F.1 FIGURES AND TABLES
	F.1.1 LIST OF FIGURES..... F-1
	F.1.2 LIST OF TABLES..... F-2

TABLE OF CONTENTS

The 489 Generator Management Relay is a microprocessor-based relay designed for the protection and management of synchronous and induction generators. The 489 is equipped with 6 output relays for trips and alarms. Generator protection, fault diagnostics, power metering, and RTU functions are integrated into one economical drawout package. The single line diagram below illustrates the 489 functionality using ANSI (American National Standards Institute) device numbers.

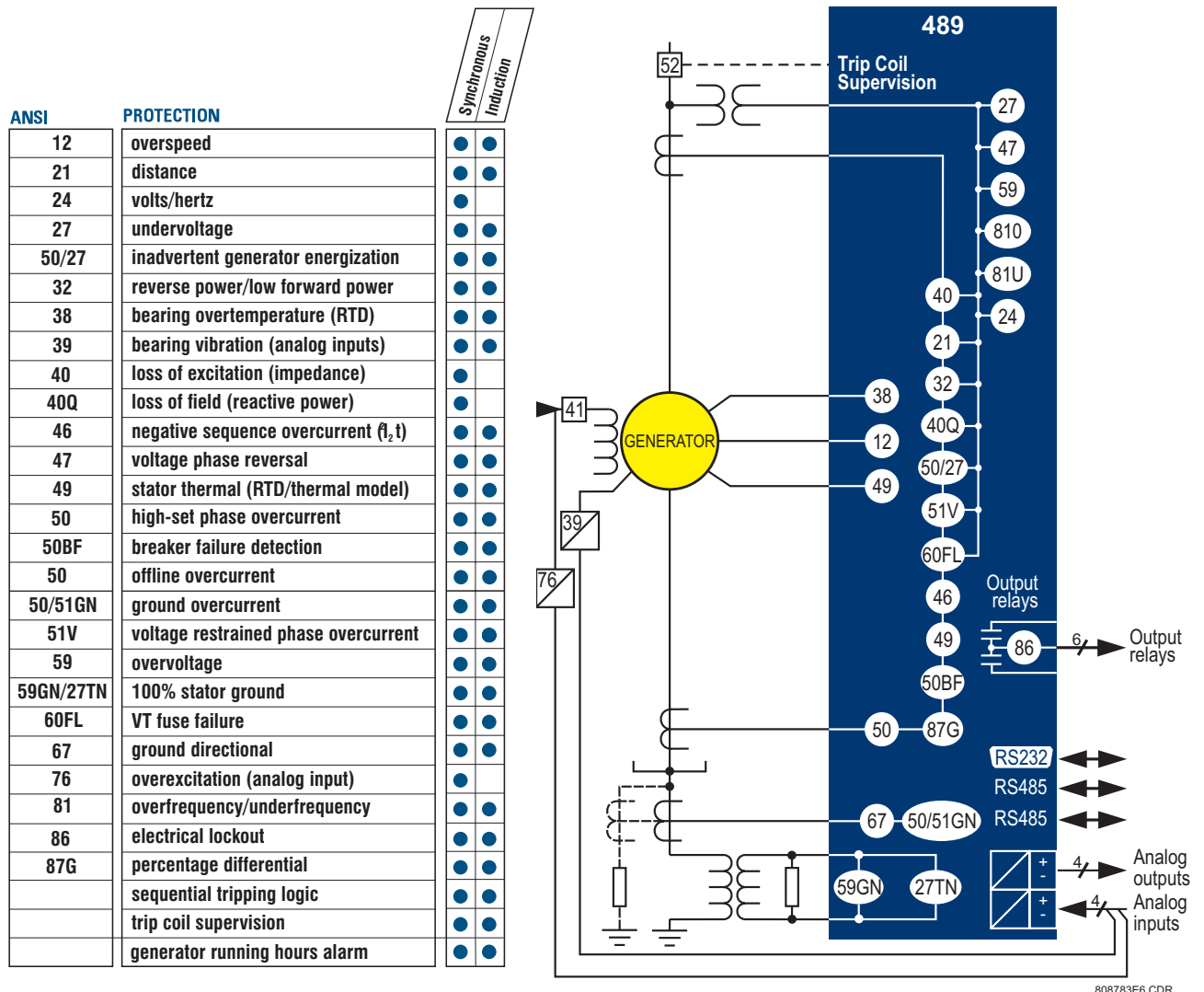

Figure 1-1: SINGLE LINE DIAGRAM

Fault diagnostics are provided through pretrip data, event record, waveform capture, and statistics. Prior to issuing a trip, the 489 takes a snapshot of the measured parameters and stores them in a record with the cause of the trip. This pre-trip data may be viewed using the **NEXT** key before the trip is reset, or by accessing the last trip data in actual values page 1. The event recorder stores a maximum of 40 time and date stamped events including the pre-trip data. Every time a trip occurs, the 489 stores a 16 cycle trace for all measured AC quantities. Trip counters record the number of occurrences of each type of trip. Minimum and maximum values for RTDs and analog inputs are also recorded. These features allow the operator to pinpoint a problem quickly and with certainty.

A complete list protection features may be found below in the table below:

Table 1–1: TRIP AND ALARM PROTECTION FEATURES

TRIP PROTECTION	ALARM PROTECTION
7 assignable digital inputs: general input, sequential trip (low forward power or reverse power), field-breaker discrepancy, and tachometer	7 assignable digital inputs: general input and tachometer
offline overcurrent (protection during startup)	overload
inadvertent energization	negative sequence
phase overcurrent with voltage restraint	ground overcurrent
negative sequence overcurrent	ground directional
ground overcurrent	undervoltage
percentage phase differential	overvoltage
ground directional	volts/hertz
high-set phase overcurrent	underfrequency
undervoltage	overfrequency
overvoltage	neutral overvoltage (fundamental)
volts/hertz	neutral undervoltage (3rd harmonic)
voltage phase reversal	reactive power (kvar)
underfrequency (two step)	reverse power
overfrequency (two step)	low forward power
neutral overvoltage (fundamental)	RTD: stator, bearing, ambient, other
neutral undervoltage (3rd harmonic)	short/low RTD
loss of excitation (2 impedance circles)	open RTD
distance element (2 zones of protection)	thermal overload
reactive power (kvar) for loss of field	trip counter
reverse power for anti-motoring	breaker failure
low forward power	trip coil monitor
RTDs: stator, bearing, ambient, other	VT fuse failure
thermal overload	demand: current, MW, Mvar, MVA
analog inputs 1 to 4	generator running hours
electrical lockout	analog inputs 1 to 4
	service (self-test failures)
	IRIG-B failure

Power metering is a standard feature in the 489. The table below outlines the metered parameters available to the operator or plant engineer either through the front panel or communications ports. The 489 is equipped with three fully functional and independent communications ports. The front panel RS232 port may be used for setpoint programming, local interrogation or control, and firmware upgrades. The computer RS485 port may be connected to a PLC, DCS, or PC based interface software. The auxiliary RS485 port may be used for redundancy or simultaneous interrogation and/or control from a second PLC, DCS, or PC program. There are also four 4 to 20 mA transducer outputs that may be assigned to any measured parameter. The range of these outputs is scalable. Additional features are outlined below.

Table 1–2: METERING AND ADDITIONAL FEATURES

METERING	ADDITIONAL FEATURES
voltage (phasors) current (phasors) and amps demand real power, MW demand, MWh apparent power and MVA demand reactive power, Mvar demand, Mvarh positive/negative frequency power factor RTD speed in RPM with a key phasor Input user programmable analog inputs	drawout case (for ease of maintenance and testing) breaker failure trip coil supervision VT fuse failure simulation flash memory for easy firmware updates

1.1.2 ORDER INFORMATION

1

All features of the 489 are standard, there are no options. The phase CT secondaries must be specified at the time of order. The control power and analog output range must also be specified at the time of order. There are two ground CT inputs: one for the GE Power Management HGF core balance CT and one for a ground CT with a 1 A secondary (may also be used to accommodate 5 A secondary). The VT inputs accommodate VTs in either a delta or wye configuration. The output relays are always non-failsafe with the exception of the service relay. The 489PC software is provided with each unit. A metal demo case may be ordered for demonstration or testing purposes.

489		*	*	*	
489					Basic unit
	P1				Current Transformer Inputs: 1 A CT Secondaries
	P5				Current Transformer Inputs: 5 A CT Secondaries
		LO			DC: 25-60 V; AC: 20-48 V @ 48-62 Hz
		HI			DC: 90-300 V; AC: 70-265 V @ 48-62 Hz
			A1		0-1 mA analog outputs
			A20		4-20 mA analog outputs

Figure 1–2: 489 ORDER CODES

1.1.3 OTHER ACCESSORIES

Additional 489 accessories are listed below.

- **489PC software:** Shipped free with 489
- **DEMO:** Metal carry case in which 489 unit may be mounted
- **SR 19-1 PANEL:** Single cutout for 19" panel
- **SR 19-2 PANEL:** Double cutout for 19" panel
- **SCI MODULE:** RS232 to RS485 converter box, designed for harsh industrial environments
- **Phase CT:** 50, 75, 100, 150, 200, 250, 300, 350, 400, 500, 600, 750, 1000 phase CT primaries
- **HGF3, HGF5, HGF8:** For sensitive ground detection on high resistance grounded systems
- **489 1 3/8" Collar:** For shallow switchgear, reduces the depth of the relay by 1 3/8"
- **489 3" Collar:** For shallow switchgear, reduces the depth of the relay by 3"

POWER SUPPLY

Options:	LO / HI (must be specified when ordering)
LO Range:	DC: 20 to 60 V DC AC: 20 to 48 V AC at 48 to 62 Hz
HI Range:	DC: 90 to 300 V DC AC: 70 to 265 V AC at 48 to 62 Hz
Power:	45 VA (max), 25 VA typical
Proper operation time without supply voltage:	30 ms

AC ANALOG INPUTS FREQUENCY TRACKING

Frequency Tracking:	V _a for wye, V _{ab} for open delta 6 V minimum, 10 Hz/sec.
---------------------	---

OUTPUT AND NEUTRAL END CURRENT INPUTS

CT Primary:	10 to 50000 A
CT Secondary:	1 A or 5 A (must be specified with order)
Conversion Range:	0.02 to 20 × CT
Accuracy:	at < 2 × CT: ±0.5% of 2 × CT at ≥ 2 × CT: ±1% of 20 × CT
Burden:	Less than 0.2 VA at rated load
CT Withstand:	1 second at 80 times rated current 2 seconds at 40 times rated current continuous at 3 times rated current

GROUND CURRENT INPUT

CT Primary:	10 to 10000 A (1 A / 5 A CTs)
CT Secondary:	1 A / 5 A or 50:0.025 (HGF CTs)
Conversion Range:	0.02 to 20 × CT for 1 A / 5 A CTs 0.0 to 100 A pri. for 50:0.025 CTs (HGF)
50:0.025 CT Accuracy:	± 0.1 A at < 10 A ± 1.0 A at ≥ 10 to 100 A
1 A / 5 A CT Accuracy:	at < 2 × CT: ±0.5% of 2 × CT at ≥ 2 × CT: ±1% of 20 × CT

GROUND CT BURDEN

GROUND CT	INPUT	BURDEN	
		VA	Ω
1 A / 5 A	1 A	0.024	0.024
	5 A	0.605	0.024
	20 A	9.809	0.024
50:0.025 HGF	0.025 A	0.057	90.7
	0.1 A	0.634	90.7
	0.5 A	18.9	75.6

GROUND CT CURRENT WITHSTAND (SECONDARY)

GROUND CT	WITHSTAND TIME		
	1 SEC.	2 SEC.	CONTINUOUS
1 A / 5 A	80 × CT	40 × CT	3 × CT
50:0.025 HGF	N/A	N/A	150 mA

PHASE VOLTAGE INPUTS

VT Ratio:	1.00 to 240.00:1 in steps of 0.01
VT Secondary:	200 V AC (full-scale)
Conversion Range:	0.02 to 1.00 × Full Scale
Accuracy:	±0.5% of Full Scale
Max. Continuous:	280 V AC
Burden:	> 500 KΩ

NEUTRAL VOLTAGE INPUT

VT Ratio:	1.00 to 240.00:1 in steps of 0.01
VT Secondary:	100 V AC (full-scale)
Conversion Range:	0.005 to 1.00 × Full Scale
Accuracy:	±0.5% of Full Scale
Max. Continuous:	280 V AC

DIGITAL INPUTS

Inputs:	9 opto-isolated inputs
External Switch:	dry contact < 400 Ω, or open collector NPN transistor from sensor 6 mA sinking from internal 4K pullup at 24 V DC with V _{ce} < 4 V DC
489 Sensor Supply:	24 V DC at 20 mA max.

RTD INPUTS

RTDs (3 wire type):	100 Ω Platinum (DIN.43760) 100 Ω Nickel, 120 Ω Nickel, 10 Ω Copper
RTD Sensing Current:	5 mA
Isolation:	36 Vpk (isolated with analog inputs and outputs)
Range:	−50 to +250°C
Accuracy:	±2°C for Platinum and Nickel ±5°C for Copper
Lead Resistance:	25 Ω Max per lead
No Sensor:	>1 kΩ
Short/Low Alarm:	< −50°C

TRIP COIL SUPERVISION

Applicable Voltage:	20 to 300 V DC/AC
Trickle Current:	2 to 5 mA

ANALOG CURRENT INPUTS

Current Inputs:	0 to 1 mA, 0 to 20 mA, 4 to 20mA (setpoint)
Input Impedance:	226 Ω ±10%
Conversion Range:	0 to 2 mA
Accuracy:	±1% of full scale
Type:	Passive
Analog Input Supply:	+24 V DC at 100 mA max.
Sampling Interval:	50 ms

COMMUNICATIONS PORTS

RS232 Port:	1, Front Panel, non-isolated
RS485 Ports:	2, Isolated together at 36 Vpk
RS485 Baud Rates:	300, 1200, 2400, 4800, 9600, 19200
RS232 Baud Rate:	9600
Parity:	None, Odd, Even
Protocol:	Modbus® RTU / half duplex, DNP 3.0

ANALOG CURRENT OUTPUT

Type: Active
 Range: 4 to 20mA, 0 to 1 mA (must be specified with order)
 Accuracy: ±1% of full scale
 4 to 20 mA max. load: 1.2 kΩ
 0 to 1mA max. load: 10 kΩ
 Isolation: 36 Vpk (isolated with RTDs and analog inputs)
 4 Assignable Outputs: Phase A, B, C output current
 3 phase average current
 negative sequence current
 generator load
 hottest stator RTD
 hottest bearing RTD
 RTD # 1 to 12
 AB voltage
 BC voltage
 CA voltage
 average phase-phase voltage
 volts/hertz
 frequency
 3rd harmonic neutral voltage
 power factor
 3 phase reactive power (Mvar)
 3 phase real power (MW)
 3 phase apparent power (MVA)
 analog inputs 1 to 4
 tachometer
 thermal capacity used
 I, Mvar, MW, MVA demands
 Torque

OUTPUT RELAYS

Configuration: 6 electromechanical Form C relays
 Contact Material: silver alloy
 Operate Time: 10 ms
 Max Ratings for 100000 operations:

VOLTAGE		MAKE/CARRY		BREAK	MAX. LOAD
		CTS	0.2 s		
DC RESISTIVE	30 V	10 A	30 A	10 A	300 W
	125 V	10 A	30 A	0.5 A	62.5 W
	250 V	10 A	30 A	0.3 A	75 W
DC INDUCTIVE L/R = 40 ms	30 V	10 A	30 A	5 A	150 W
	125 V	10 A	30 A	0.25 A	31.3 W
	250 V	10 A	30 A	0.15 A	37.5 W
AC RESISTIVE	120 V	10 A	30 A	10 A	2770 VA
	250 V	10 A	30 A	10 A	2770 VA
AC INDUCTIVE PF = 0.4	120 V	10 A	30 A	4 A	480 VA
	250 V	10 A	30 A	3 A	750 VA

TERMINALS

Low Voltage (A, B, C, D terminals): 12 AWG max
 High Voltage (E, F, G, H terminals): #8 ring lug,
 10 AWG wire standard

POWER METERING

Range: 0.000 to 2000.000 ±Mw, ±Mvar, MVA
 Accuracy
 at lavg < 2 × CT: ±1% of $\sqrt{3} \times 2 \times CT \times VT \times VT$ full-scale
 at lavg > 2 × CT: ±1.5% of $\sqrt{3} \times 20 \times CT \times VT \times VT$ full-scl.

WATTHOUR AND VARHOUR METERING

Description: Continuous total of +wathours and ±varhours
 Range: 0.000 to 4000000.000 MvarHours
 Timing Accuracy: ±0.5%
 Update Rate: 50 ms

DEMAND METERING

Metered Values: Maximum Phase Current
 3 Phase Real Power
 3 Phase Apparent Power
 3 Phase Reactive Power
 Measurement Type: Rolling Demand
 Demand Interval: 5 to 90 minutes in steps of 1
 Update Rate: 1 minute
 Elements: Alarm

GENERAL INPUT A TO G (DIGITAL INPUT)

Configurable: Assignable Digital Inputs 1 to 7
 Time Delay: 0.1 to 5000.0 s in steps of 0.1
 Block From Online: 0 to 5000 s in steps of 1
 Timing Accuracy: ±100 ms or ±0.5% of total time
 Elements: Trip, Alarm, and Control

SEQUENTIAL TRIP (DIGITAL INPUT)

Configurable: Assignable to Digital Inputs 1 to 7
 Pickup Level: 0.02 to 0.99 × rated MW in steps of 0.01
 Low Forward Power / Reverse Power
 Time Delay: 0.2 to 120.0 s in steps of 0.1
 Pickup Accuracy: see power metering
 Timing Accuracy: ±100 ms or ±0.5% of total time
 Elements: Trip

FIELD BREAKER DISCREPANCY (DIGITAL INPUT)

Configurable: Assignable to Digital Inputs 1 to 7
 Time Delay: 0.1 to 500.0 s in steps of 0.1
 Timing Accuracy: ±100 ms or ±0.5% of total time
 Elements: Trip

TACHOMETER (DIGITAL INPUT)

Configurable: Assignable to Digital Inputs 4 to 7
 RPM Measurement: 100 to 7200 RPM
 Duty Cycle of Pulse: >10%
 Pickup Level: 101 to 175 × rated speed in steps of 1
 Time Delay: 1 to 250 s in steps of 1
 Timing Accuracy: ±0.5 s or ±0.5% of total time
 Elements: Trip and Alarm

OVERCURRENT ALARM

Pick-up Level: 0.10 to 1.50 × FLA in steps of 0.01
 average phase current
 Time Delay: 0.1 to 250.0 s in steps of 0.1
 Pickup Accuracy: as per Phase Current Inputs
 Timing Accuracy: ±100 ms or ±0.5% of total time
 Elements: Alarm

OFFLINE OVERCURRENT

Pick-up Level:	0.05 to $1.00 \times CT$ in steps of 0.01 of any one phase
Time Delay:	3 to 99 cycles in steps of 1
Pickup Accuracy:	as per Phase Current Inputs
Timing Accuracy:	+50ms at 50/60 Hz
Elements:	Trip

INADVERTENT ENERGIZATION

Arming Signal:	undervoltage and/or offline from breaker status
Pick-up Level:	0.05 to $3.00 \times CT$ in steps of 0.01 of any one phase
Time Delay:	no intentional delay
Pickup Accuracy:	as per Phase Current Inputs
Timing Accuracy:	+50 ms at 50/60 Hz
Elements:	Trip

PHASE OVERCURRENT

Voltage Restraint:	Programmable fixed characteristic
Pick-up Level:	0.15 to $20.00 \times CT$ in steps of 0.01 of any one phase
Curve Shapes:	ANSI, IEC, IAC, Flexcurve, Definite Time
Time Delay:	0.000 to 100.000 s in steps of 0.001
Pickup Accuracy:	as per Phase Current Inputs
Timing Accuracy:	+50 ms at 50/60 Hz or $\pm 0.5\%$ total time
Elements:	Trip

NEGATIVE SEQUENCE OVERCURRENT

Pick-up Level:	3 to 100% FLA in steps of 1
Curve Shapes:	I_2^2t trip defined by k, definite time alarm
Time Delay:	0.1 to 100.0 s in steps of 0.1
Pickup Accuracy:	as per Phase Current Inputs
Timing Accuracy:	± 100 ms or $\pm 0.5\%$ of total time
Elements:	Trip and Alarm

GROUND OVERCURRENT

Pick-up Level:	0.05 to $20.00 \times CT$ in steps of 0.01
Curve Shapes:	ANSI, IEC, IAC, Flexcurve, Definite Time
Time Delay:	0.00 to 100.00 s in steps of 0.01
Pickup Accuracy:	as per Ground Current Input
Timing Accuracy:	+50 ms at 50/60 Hz or $\pm 0.5\%$ total time
Elements:	Trip

PHASE DIFFERENTIAL

Pick-up Level:	0.05 to $1.00 \times CT$ in steps of 0.01
Curve Shape:	Dual Slope
Time Delay:	0 to 100 cycles in steps of 1
Pickup Accuracy:	as per Phase Current Inputs
Timing Accuracy:	+50 ms at 50/60 Hz or $\pm 0.5\%$ total time
Elements:	Trip

GROUND DIRECTIONAL

Pickup Level:	0.05 to $20.00 \times CT$ in steps of 0.01
Time Delay:	0.1 to 120.0 s in steps of 0.1
Pickup Accuracy:	as per Phase Current Inputs
Timing Accuracy:	± 100 ms or $\pm 0.5\%$ of total time
Elements:	Trip and Alarm

HIGH-SET PHASE OVERCURRENT

Pickup Level:	0.15 to $20.00 \times CT$ in steps of 0.01
Time Delay:	0.00 to 100.00 s in steps of 0.01
Pickup Accuracy:	as per Phase Current Inputs
Timing Accuracy:	± 50 ms at 50/60 Hz or $\pm 0.5\%$ total time
Elements:	Trip

UNDERVOLTAGE

Pick-up Level:	0.50 to $0.99 \times$ rated V in steps of 0.01
Curve Shapes:	Inverse Time, definite time alarm
Time Delay:	0.2 to 120.0 s in steps of 0.1
Pickup Accuracy:	as per Voltage Inputs
Timing Accuracy:	± 100 ms or $\pm 0.5\%$ of total time
Elements:	Trip and Alarm

OVERVOLTAGE

Pick-up Level:	1.01 to $1.50 \times$ rated V in steps of 0.01
Curve Shapes:	Inverse Time, definite time alarm
Time Delay:	0.2 to 120.0 s in steps of 0.1
Pickup Accuracy:	as per Voltage Inputs
Timing Accuracy:	± 100 ms or $\pm 0.5\%$ of total time
Elements:	Trip and Alarm

VOLTS/HERTZ

Pick-up Level:	1.00 to $1.99 \times$ nominal in steps of 0.01
Curve Shapes:	Inverse Time, definite time alarm
Time Delay:	0.1 to 120.0 s in steps of 0.1
Pickup Accuracy:	as per voltage inputs
Timing Accuracy:	± 100 ms at $\geq 1.2 \times$ Pickup ± 300 ms at $< 1.2 \times$ Pickup
Elements:	Trip and Alarm

VOLTAGE PHASE REVERSAL

Configuration:	ABC or ACB phase rotation
Timing Accuracy:	200 to 400 ms
Elements:	Trip

UNDERFREQUENCY

Required Voltage:	0.50 to $0.99 \times$ rated voltage in Phase A
Block From Online:	0 to 5 sec. in steps of 1
Pick-up Level:	20.00 to 60.00 in steps of 0.01
Curve Shapes:	1 level alarm, two level trip definite time
Time Delay:	0.1 to 5000.0 sec. in steps of 0.1
Pickup Accuracy:	± 0.02 Hz
Timing Accuracy:	± 100 ms or $\pm 0.5\%$ of total time
Elements:	Trip and Alarm

OVERFREQUENCY

Required Voltage:	0.50 to $0.99 \times$ rated voltage in Phase A
Block From Online:	0 to 5 sec. in steps of 1
Pick-up Level:	25.01 to 70.00 in steps of 0.01
Curve Shapes:	1 level alarm, 2 level trip definite time
Time Delay:	0.1 to 5000.0 s in steps of 0.1
Pickup Accuracy:	± 0.02 Hz
Timing Accuracy:	± 100 ms or $\pm 0.5\%$ of total time
Elements:	Trip and Alarm

NEUTRAL OVERVOLTAGE (FUNDAMENTAL)

Pick-up Level:	2.0 to 100.0 V secondary in steps of 0.01
Time Delay:	0.1 to 120.0 s in steps of 0.1
Pickup Accuracy:	as per Neutral Voltage Input
Timing Accuracy:	±100 ms or ±0.5% of total time
Elements:	Trip and Alarm

NEUTRAL UNDERVOLTAGE (3RD HARMONIC)

Blocking Signals:	Low power and low voltage if open delta
Pick-up Level:	0.5 to 20.0 V secondary in steps of 0.01 if open delta VT; adaptive if wye VT
Time Delay:	5 to 120 s in steps of 1
Pickup Accuracy:	as per Neutral Voltage Input
at ≤20.0 V secondary:	±5% of pickup
at >20.0 V secondary:	±5% of pickup
Timing Accuracy:	±3.0 s
Elements:	Trip and Alarm

LOSS OF EXCITATION (IMPEDANCE)

Pickup Level:	2.5 to 300.0 Ω secondary in steps of 0.1 with adjustable impedance offset 1.0 to 300.0 Ω secondary in steps of 0.1
Time Delay:	0.1 to 10.0 s in steps of 0.1
Pickup Accuracy:	as per Voltage and Phase Current Inputs
Timing Accuracy:	±100 ms or ±0.5% of total time
Elements:	Trip (2 zones using impedance circles)

DISTANCE (IMPEDANCE)

Pickup Levels:	0.1 to 500.0 Ω secondary in steps of 0.1 50 to 85° reach in steps of 1
Time Delay:	0.0 to 150.0 s in steps of 0.1
Pickup Accuracy:	as per Voltage and Phase Current Inputs
Timing Accuracy:	150 ms ±50 ms or ±0.5% of total time
Elements:	Trip (two trip zones)

REACTIVE POWER

Block From Online:	0 to 5000 s in steps of 1
Pick- up Level:	0.02 to 1.50 × rated Mvar (positive and negative)
Time Delay:	0.2 to 120.0 s in steps of 0.1
Pickup Accuracy:	see power metering
Timing Accuracy:	±100ms or ±0.5% of total time
Elements:	Trip and Alarm

REVERSE POWER

Block From Online:	0 to 5000 s in steps of 1
Pick- up Level:	0.02 to 0.99 × rated MW
Time Delay:	0.2 to 120.0 s in steps of 0.1
Pickup Accuracy:	see power metering
Timing Accuracy:	±100 ms or ±0.5% of total time
Elements:	Trip and Alarm

LOW FORWARD POWER

Block From Online:	0 to 15000 s in steps of 1
Pick- up Level:	0.02 to 0.99 × rated MW
Time Delay:	0.2 to 120.0 s in steps of 0.1
Pickup Accuracy:	see power metering
Timing Accuracy:	±100 ms or ±0.5% of total time
Elements:	Trip and Alarm

PULSE OUTPUT

Parameters:	+ kwh, +kvarh, -kvarh
Interval:	1 to 50000 in steps of 1
Pulse Width:	200 to 1000 ms in steps of 1 ms

RTDS 1 TO 12

Pickup:	1 to 250°C in steps of 1
Pickup Hysteresis:	2°C
Time Delay:	3 sec.
Elements:	Trip and Alarm

OVERLOAD / STALL PROTECTION / THERMAL MODEL

Overload Curves:	15 Standard Overload Curves Custom Curve Voltage Dependent Custom Curve (all curves time out against average phase current)
Curve Biasing:	Phase Unbalance Hot/Cold Curve Ratio Stator RTD Online Cooling Rate Offline Cooling Rate Line Voltage
Overload Pickup:	1.01 to 1.25
Pickup Accuracy:	as per Phase Current Inputs
Timing Accuracy:	±100 ms or ±2% of total time
Elements:	Trip and Alarm

OTHER FEATURES

Serial Start/Stop Initiation
Remote Reset (Configurable Digital Input)
Test Input (Configurable Digital Input)
Thermal Reset (Configurable Digital Input)
Dual Setpoints
Pre-Trip Data
Event Recorder
Waveform Memory
Fault Simulation
VT Failure
Trip Counter
Breaker Failure
Trip Coil Monitor
Generator Running Hours Alarm
IRIG-B Failure Alarm

ENVIRONMENTAL

Ambient Operating Temperature:	-40°C to +60°C
Ambient Storage Temperature:	40°C to +80°C.
Humidity:	Up to 90%, noncondensing.
Altitude:	Up to 2000 m
Pollution Degree:	2



It is recommended that the 489 be powered up at least once per year to prevent deterioration of electrolytic capacitors in the power supply.

CASE

Drawout:	Fully drawout (Automatic CT shorts)
Seal:	Seal provision
Door:	Dust tight door
Mounting:	Panel or 19" rack mount
IP Class:	IP20-X

PRODUCTION TESTS

Thermal Cycling:	Operational test at ambient, reducing to -40°C and then increasing to 60°C
Dielectric Strength:	2.0 kV for 1 minute from relays, CTs, VTs, power supply to Safety Ground



DO NOT CONNECT FILTER GROUND TO SAFETY GROUND DURING TEST!

FUSE

Current Rating:	3.15 A
Type:	5 × 20 mm Slo-Blo Littelfuse, High Breaking Capacity
Model#:	215.315



An external fuse must be used if supply voltage exceeds 250V

TYPE TESTS

Dielectric Strength:	Per IEC 255-5 and ANSI/IEEE C37.90. 2.0 kV for 1 minute from relays, CTs, VTs, power supply to Safety Ground
----------------------	--



DO NOT CONNECT FILTER GROUND TO SAFETY GROUND DURING TEST

Insulation Resistance:	IEC255-5 500 V DC, from relays, CTs, VTs, power supply to Safety Ground
------------------------	---



DO NOT CONNECT FILTER GROUND TO SAFETY GROUND DURING TEST

Transients:	ANSI C37.90.1 oscillatory (2.5 kV/ 1 MHz); ANSI C37.90.1 Fast Rise (5 kV/ 10 ns); Ontario Hydro A-28M-82; IEC255-4 Impulse/High Frequency Disturbance Class III Level
Impulse Test:	IEC 255-5 0.5 Joule 5 kV
RFI:	50 MHz / 15 W Transmitter
EMI:	C37.90.2 Electromagnetic Interference at 150 MHz and 450 MHz, 10V/m
Static:	IEC 801-2 Static Discharge
Humidity:	90% non-condensing
Temperature:	-40°C to +60°C ambient
Environment:	IEC 68-2-38 Temperature/Humidity cycle
Vibration:	Sinusoidal Vibration 8.0 g for 72 hrs.

PACKAGING

Shipping Box:	12" × 11" × 10" (W × H × D) 30.5cm × 27.9cm × 25.4cm
Shipping Weight:	17 lbs Max / 7.7 kg

CERTIFICATION

ISO:	Manufactured under an ISO9001 registered system.
UL:	UL
CSA:	CSA
CE:	Conforms to IEC 947-1, IEC 1010-1

2.1.1 DESCRIPTION

The 489 is packaged in the standard GE Power Management SR series arrangement, which consists of a drawout unit and a companion fixed case. The case provides mechanical protection to the unit, and is used to make permanent connections to all external equipment. The only electrical components mounted in the case are those required to connect the unit to the external wiring. Connections in the case are fitted with mechanisms required to allow the safe removal of the relay unit from an energized panel, such as automatic CT shorting. The unit is mechanically held in the case by pins on the locking handle, which cannot be fully lowered to the locked position until the electrical connections are completely mated. Any 489 can be installed in any 489 case, except for custom manufactured units that are clearly identified as such on both case and unit, and are equipped with an index pin keying mechanism to prevent incorrect pairings.

No special ventilation requirements need to be observed during the installation of the unit, but the unit should be wiped clean with a damp cloth.

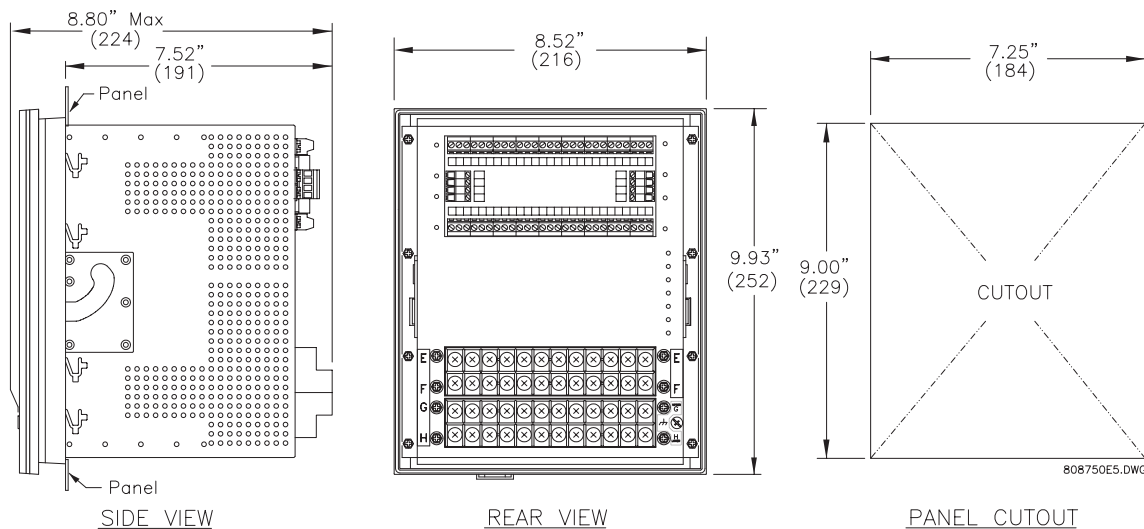

Figure 2-1: 489 DIMENSIONS

To prevent unauthorized removal of the drawout unit, a wire lead seal can be installed in the slot provided on the handle as shown below. With this seal in place, the drawout unit cannot be removed. A passcode or setpoint access jumper can be used to prevent entry of setpoints but still allow monitoring of actual values. If access to the front panel controls must be restricted, a separate seal can be installed on the outside of the cover to prevent it from being opened.

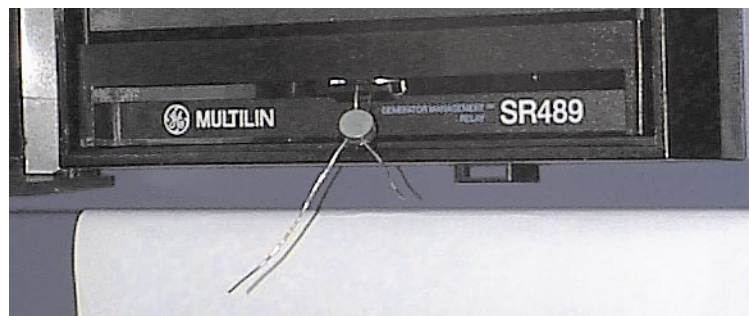

Figure 2-2: DRAWOUT UNIT SEAL



Hazard may result if the product is not used for its intended purpose.

2.1.2 PRODUCT IDENTIFICATION

Each 489 unit and case are equipped with a permanent label. This label is installed on the left side (when facing the front of the relay) of both unit and case. The case label details which units can be installed.

The case label details the following information:

- MODEL NUMBER
- MANUFACTURE DATE
- SPECIAL NOTES

The unit label details the following information:

- MODEL NUMBER
- TYPE
- SERIAL NUMBER
- FILE NUMBER
- MANUFACTURE DATE
- PHASE CURRENT INPUTS
- SPECIAL NOTES
- OVERVOLTAGE CATEGORY
- INSULATION VOLTAGE
- POLLUTION DEGREE
- CONTROL POWER
- OUTPUT CONTACT RATING



Figure 2-3: CASE AND UNIT IDENTIFICATION LABELS

2.1.3 INSTALLATION

The 489 case, alone or adjacent to another SR unit, can be installed in a standard 19-inch rack panel (see Figure 2–1: 489 DIMENSIONS on page 2–1). Provision must be made for the front door to swing open without interference to, or from, adjacent equipment. The 489 unit is normally mounted in its case when shipped from the factory and should be removed before mounting the case in the supporting panel. Unit withdrawal is described in the next section.

After the mounting hole in the panel has been prepared, slide the 489 case into the panel from the front. Applying firm pressure on the front to ensure the front bezel fits snugly against the front of the panel, bend out the pair of retaining tabs (to a horizontal position) from each side of the case, as shown below. The case is now securely mounted, ready for panel wiring.

2

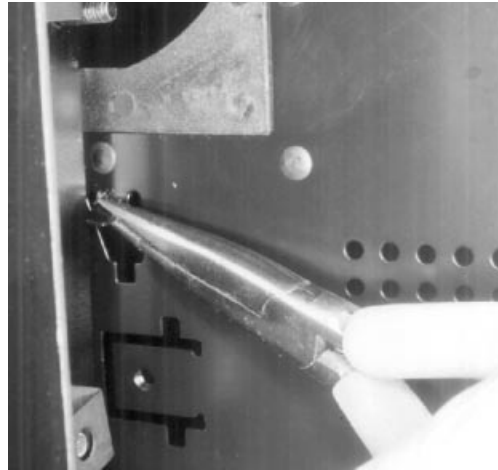

Figure 2–4: BEND UP MOUNTING TABS

2.1.4 UNIT WITHDRAWAL AND INSERTION



TURN OFF CONTROL POWER BEFORE DRAWING OUT OR RE-INSERTING THE RELAY TO PREVENT MAL-OPERATION!

To remove the unit from the case:

1. Open the cover by pulling the upper or lower corner of the right side, which will rotate about the hinges on the left.
2. Release the locking latch, located below the locking handle, by pressing upward on the latch with the tip of a screwdriver.



Figure 2–5: PRESS LATCH TO DISENGAGE HANDLE

- Grasp the locking handle in the center and pull firmly, rotating the handle up from the bottom of the unit until movement ceases.



Figure 2-6: ROTATE HANDLE TO STOP POSITION

- Once the handle is released from the locking mechanism, the unit can freely slide out of the case when pulled by the handle. It may sometimes be necessary to adjust the handle position slightly to free the unit.

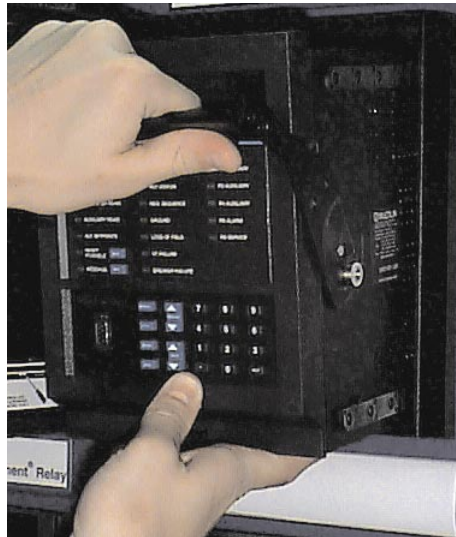

Figure 2-7: SLIDE UNIT OUT OF CASE

To insert the unit into the case:

- Raise the locking handle to the highest position.
- Hold the unit immediately in front of the case and align the rolling guide pins (near the hinges of the locking handle) to the guide slots on either side of the case.
- Slide the unit into the case until the guide pins on the unit have engaged the guide slots on either side of the case.



If an attempt is made to install a unit into a non-matching case, the mechanical key will prevent full insertion of the unit. Do not apply strong force in the following step or damage may result.

- Grasp the locking handle from the center and press down firmly, rotating the handle from the raised position toward the bottom of the unit.
- When the unit is fully inserted, the latch will be heard to click, locking the handle in the final position.

2.1.5 TERMINAL LOCATIONS

2

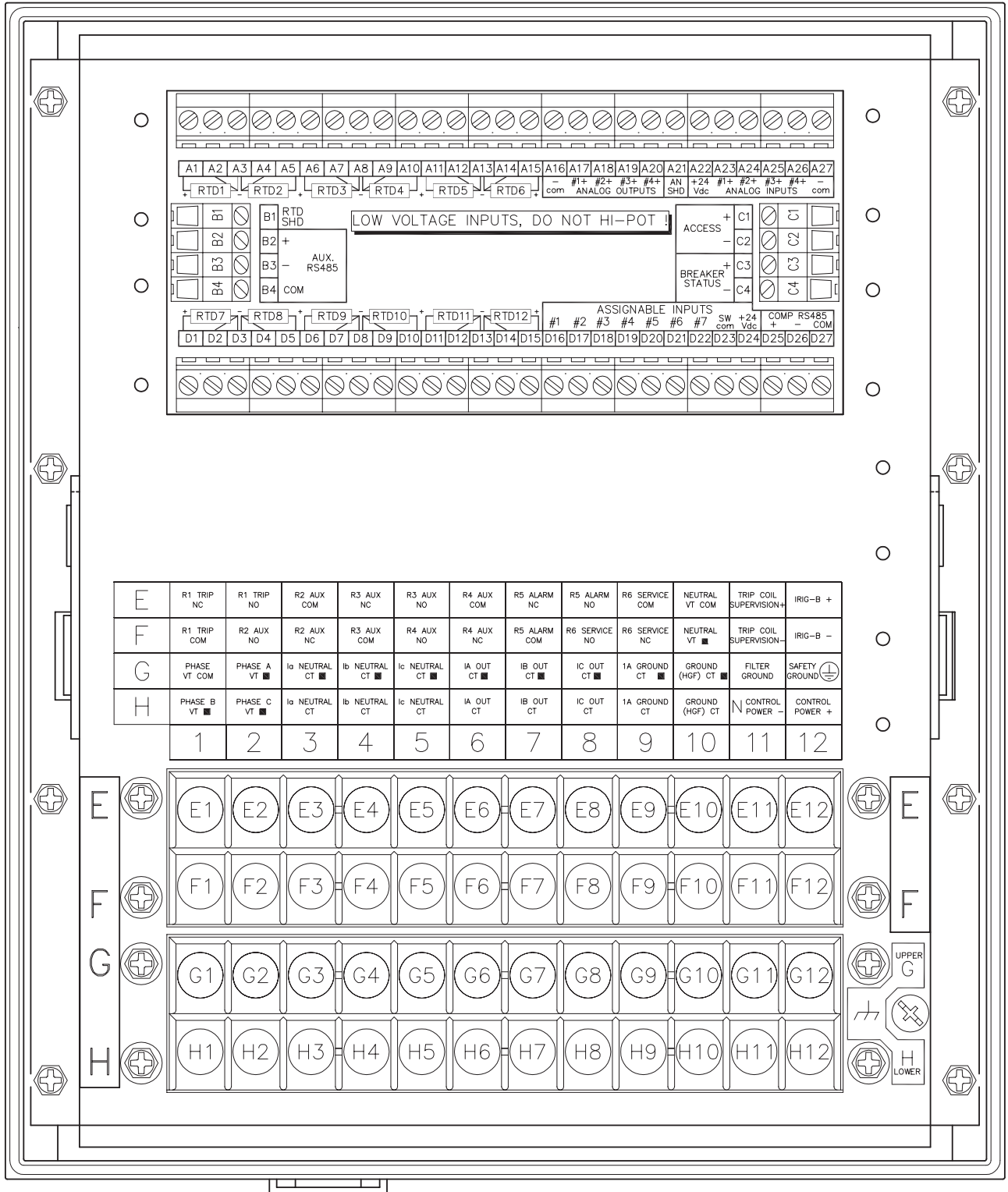

808759E5.DWG

Figure 2-8: TERMINAL LAYOUT

Table 2–1: 489 TERMINAL LIST

TERM.	DESCRIPTION
A01	RTD #1 HOT
A02	RTD #1 COMPENSATION
A03	RTD RETURN
A04	RTD #2 COMPENSATION
A05	RTD #2 HOT
A06	RTD #3 HOT
A07	RTD #3 COMPENSATION
A08	RTD RETURN
A09	RTD #4 COMPENSATION
A10	RTD #4 HOT
A11	RTD #5 HOT
A12	RTD #5 COMPENSATION
A13	RTD RETURN
A14	RTD #6 COMPENSATION
A15	RTD #6 HOT
A16	ANALOG OUT COMMON –
A17	ANALOG OUT 1 +
A18	ANALOG OUT 2 +
A19	ANALOG OUT 3 +
A20	ANALOG OUT 4 +
A21	ANALOG SHIELD
A22	ANALOG INPUT 24 V DC POWER SUPPLY +
A23	ANALOG INPUT 1 +
A24	ANALOG INPUT 2 +
A25	ANALOG INPUT 3 +
A26	ANALOG INPUT 4 +
A27	ANALOG INPUT COMMON –
B01	RTD SHIELD
B02	AUXILIARY RS485 +
B03	AUXILIARY RS485 –
B04	AUXILIARY RS485 COMMON
C01	ACCESS +
C02	ACCESS –
C03	BREAKER STATUS +
C04	BREAKER STATUS –
D01	RTD #7 HOT
D02	RTD #7 COMPENSATION
D03	RTD RETURN
D04	RTD #8 COMPENSATION
D05	RTD #8 HOT
D06	RTD #9 HOT
D07	RTD #9 COMPENSATION
D08	RTD RETURN
D09	RTD #10 COMPENSATION
D10	RTD #10 HOT
D11	RTD #11 HOT
D12	RTD #11 COMPENSATION
D13	RTD RETURN
D14	RTD #12 COMPENSATION
D15	RTD #12 HOT
D16	ASSIGNABLE SW. 01
D17	ASSIGNABLE SW. 02
D18	ASSIGNABLE SW. 03
D19	ASSIGNABLE SW. 04
D20	ASSIGNABLE SW. 05

TERM.	DESCRIPTION
D21	ASSIGNABLE SW. 06
D22	ASSIGNABLE SW. 07
D23	SWITCH COMMON
D24	SWITCH +24 V DC
D25	COMPUTER RS485 +
D26	COMPUTER RS485 –
D27	COMPUTER RS485 COMMON
E01	R1 TRIP NC
E02	R1 TRIP NO
E03	R2 AUXILIARY COMMON
E04	R3 AUXILIARY NC
E05	R3 AUXILIARY NO
E06	R4 AUXILIARY COMMON
E07	R5 ALARM NC
E08	R5 ALARM NO
E09	R6 SERVICE COMMON
E10	NEUTRAL VT COMMON
E11	COIL SUPERVISION +
E12	IRIG-B +
F01	R1 TRIP COMMON
F02	R2 AUXILIARY NO
F03	R2 AUXILIARY NC
F04	R3 AUXILIARY COMMON
F05	R4 AUXILIARY NO
F06	R4 AUXILIARY NC
F07	R5 ALARM COMMON
F08	R6 SERVICE NO
F09	R6 SERVICE NC
F10	NEUTRAL VT +
F11	COIL SUPERVISION –
F12	IRIG-B –
G01	PHASE VT COMMON
G02	PHASE A VT •
G03	NEUTRAL PHASE A CT •
G04	NEUTRAL PHASE B CT •
G05	NEUTRAL PHASE C CT •
G06	OUTPUT PHASE A CT •
G07	OUTPUT PHASE B CT •
G08	OUTPUT PHASE C CT •
G09	1A GROUND CT •
G10	HGF GROUND CT •
G11	FILTER GROUND
G12	SAFETY GROUND
H01	PHASE B VT •
H02	PHASE C VT •
H03	NEUTRAL PHASE A CT
H04	NEUTRAL PHASE B CT
H05	NEUTRAL PHASE C CT
H06	OUTPUT PHASE A CT
H07	OUTPUT PHASE B CT
H08	OUTPUT PHASE C CT
H09	1A GROUND CT
H10	HGF GROUND CT
H11	CONTROL POWER –
H12	CONTROL POWER +

2.2.1 TYPICAL WIRING DIAGRAM

2

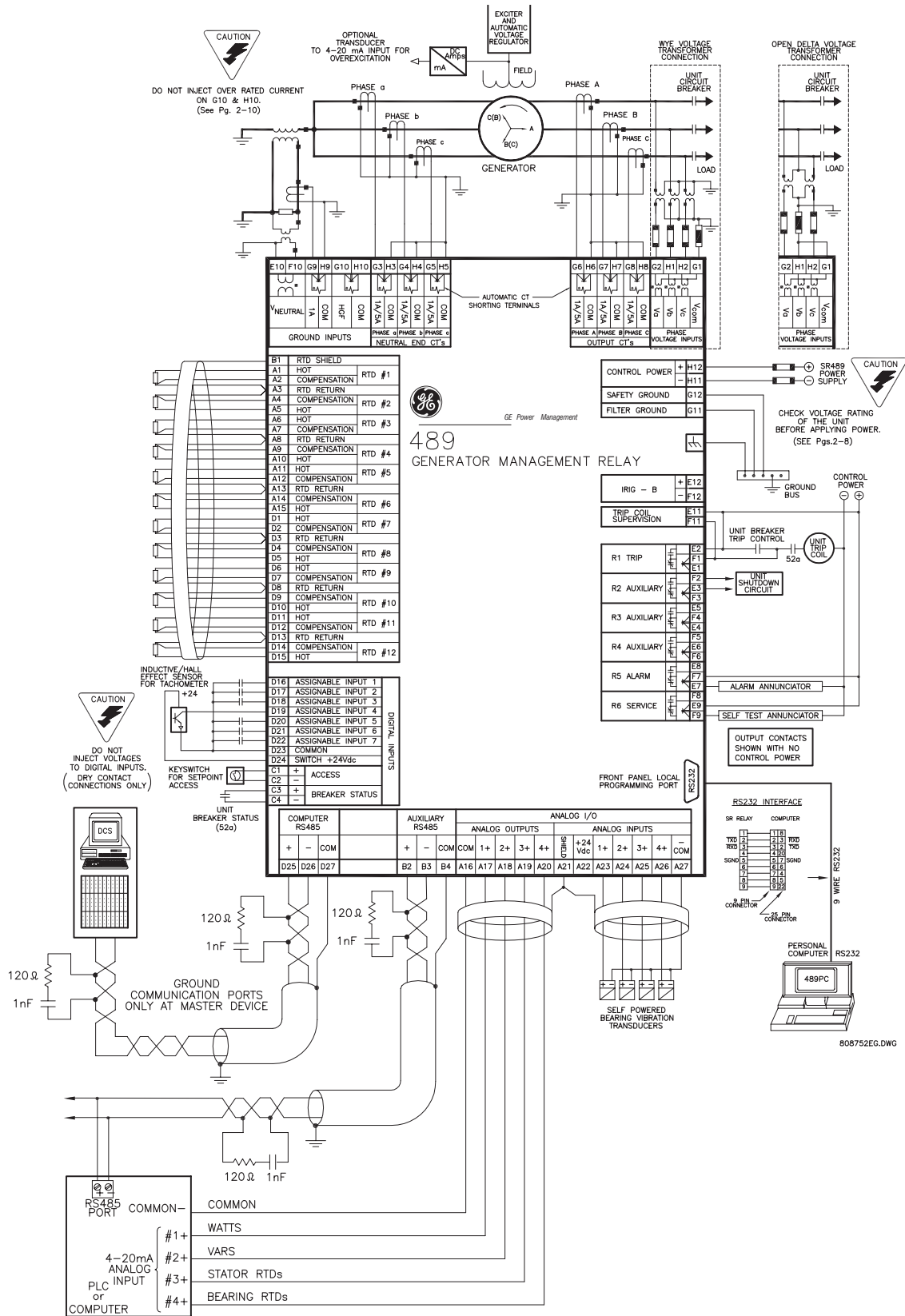

Figure 2-9: TYPICAL WIRING DIAGRAM

2.2.2 TYPICAL WIRING

A broad range of applications are available to the user and it is not possible to present typical connections for all possible schemes. The information in this section will cover the important aspects of interconnections, in the general areas of instrument transformer inputs, other inputs, outputs, communications and grounding. See Figure 2-8: TERMINAL LAYOUT and Table 2-1: 489 TERMINAL LIST for terminal arrangement, and Figure 2-9: TYPICAL WIRING DIAGRAM for typical connections.

2

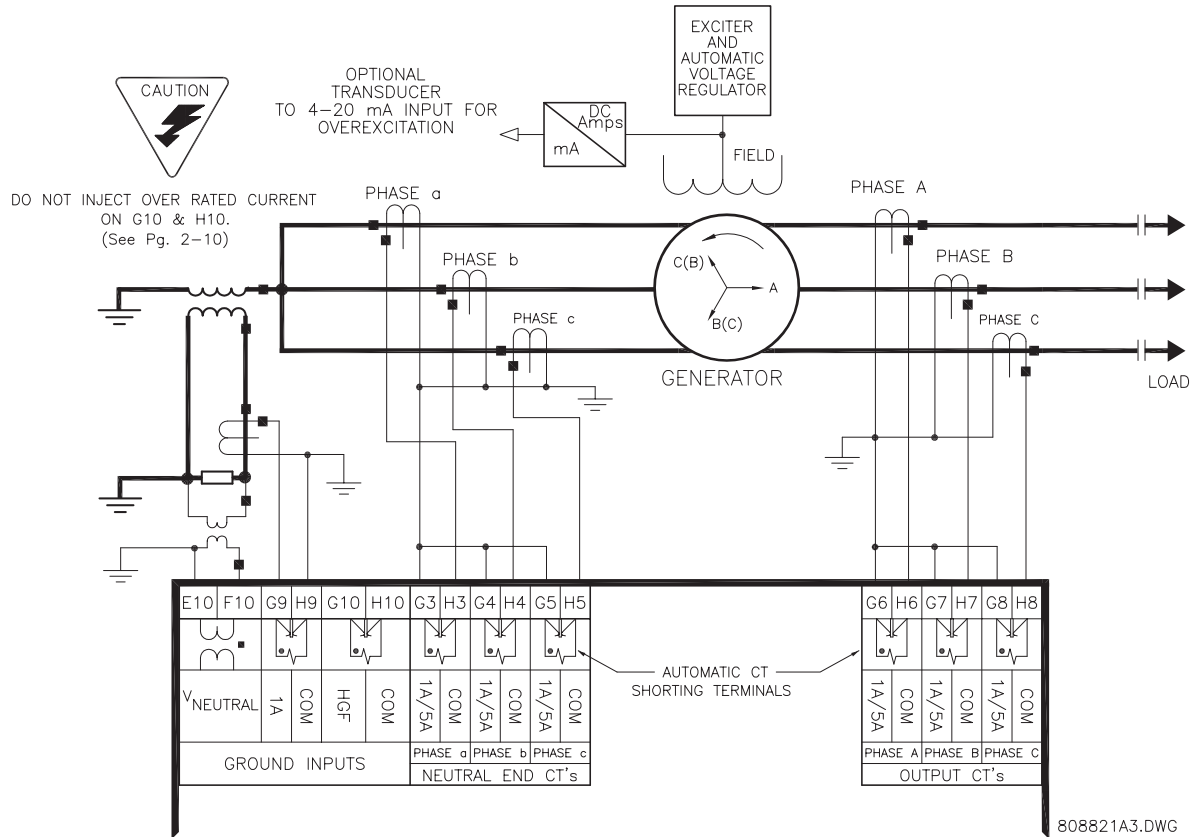

Figure 2-10: TYPICAL WIRING (DETAIL)

2.2.3 CONTROL POWER



Control power supplied to the 489 must match the installed switching power supply. If the applied voltage does not match, damage to the unit may occur.

The order code from the terminal label on the side of the drawout unit specifies the nominal control voltage as one of the following:

- LO: 20 to 60 V DC; 20 to 48 V AC
- HI: 90 to 300 V DC; 70 to 265 V AC

Ensure applied control voltage and rated voltage on drawout case terminal label match. For example, the HI power supply will work with any DC voltage from 90 to 300 V, or AC voltage from 70 to 265 V. The internal fuse may blow if the applied voltage exceeds this range.

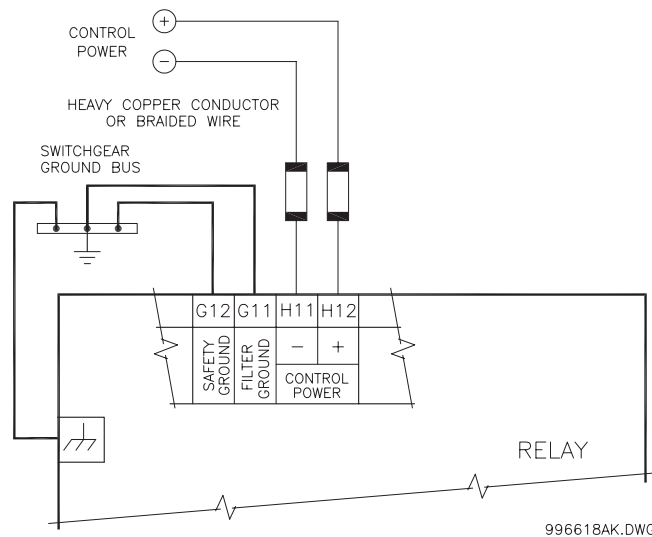

Figure 2-11: CONTROL POWER CONNECTION

Extensive filtering and transient protection are built into the 489 to ensure proper operation in harsh industrial environments. Transient energy must be conducted back to the source through the filter ground terminal. A separate safety ground terminal is provided for hi-pot testing.



All grounds **MUST** be hooked up for normal operation regardless of control power supply type.

2.2.4 PHASE CURRENT INPUTS

The 489 has six phase current transformer inputs (three output side and three neutral end), each with an isolating transformer. There are no internal ground connections on the CT inputs. Each phase CT circuit is shorted by automatic mechanisms on the 489 case if the unit is withdrawn. The phase CTs should be chosen such that the FLA is no less than 50% of the rated phase CT primary. Ideally, the phase CT primary should be chosen such that the FLA is 100% of the phase CT primary or slightly less. This will ensure maximum accuracy for the current measurements. The maximum phase CT primary current is 50000 A.

The 489 will measure correctly up to 20 times the phase current nominal rating. Since the conversion range is large, 1 A or 5 A CT secondaries must be specified at the time of order such that the appropriate interposing CT may be installed in the unit. CTs chosen must be capable of driving the 489 phase CT burden (see SPECIFICATIONS for ratings).



Verify that the 489 nominal phase current of 1 A or 5 A matches the secondary rating and connections of the connected CTs. Unmatched CTs may result in equipment damage or inadequate protection. Polarity of the phase CTs is critical for phase differential, negative sequence, power measurement, and residual ground current detection (if used).

2.2.5 GROUND CURRENT INPUT

2

The 489 has a dual primary isolating transformer for ground CT connections. There are no internal ground connections on the ground current inputs. The ground CT circuits are shorted by automatic mechanisms on the case if the unit is withdrawn. The 1 A tap is used for 1 A or 5 A secondary CTs in either core balance or residual ground configurations. If the 1 A tap is used, the 489 measures up to 20 A secondary with a maximum ground CT ratio of 10000:1. The chosen ground CT must be capable of driving the ground CT burden (see SPECIFICATIONS).

The HGF ground CT input is designed for sensitive ground current detection on high resistance grounded systems where the GE Power Management HGF core balance CT (50:0.025) is used. In applications such as mines, where earth leakage current must be measured for personnel safety, primary ground current as low as 0.25 A may be detected with the GE Power Management HGF CT. Only one ground CT input tap should be used on a given unit.



Only one ground input should be wired. The other input should be unconnected.

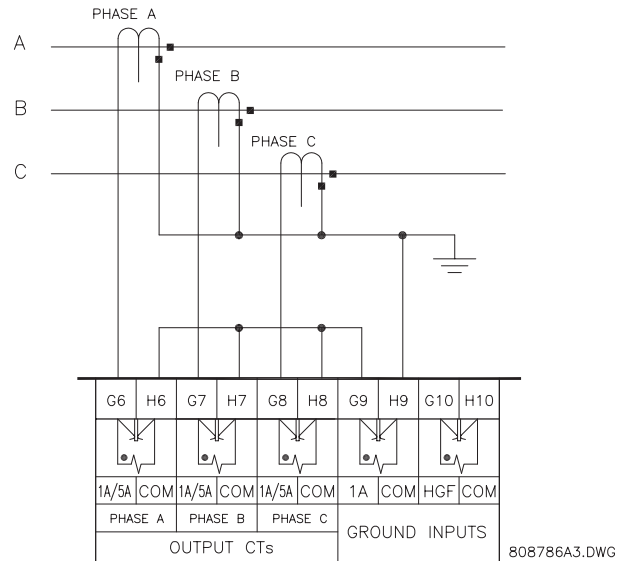
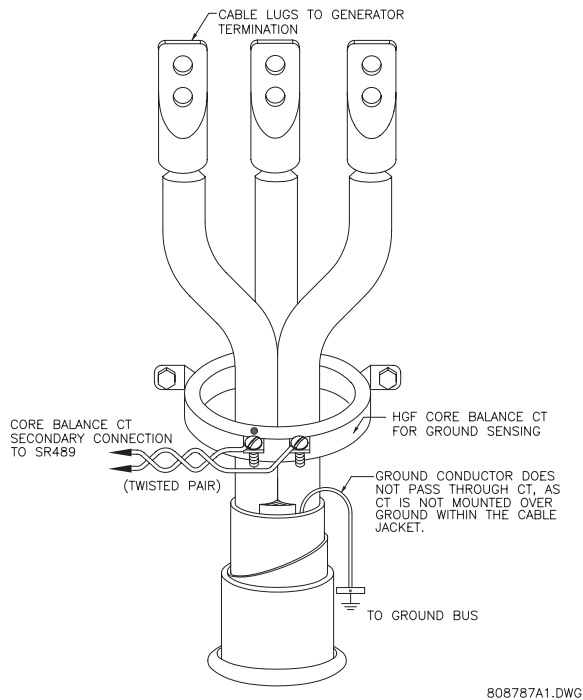

Figure 2-12: RESIDUAL GROUND CT CONNECTION



DO NOT INJECT OVER THE RATED CURRENT TO HGF TERMINAL (0.25 to 25 A PRIMARY)

The exact placement of a zero sequence CT to detect ground fault current is shown below. If the core balance CT is placed over shielded cable, capacitive coupling of phase current into the cable shield may be detected as ground current unless the shield wire is also passed through the CT window. Twisted pair cabling on the zero sequence CT is recommended.



808787A1.DWG

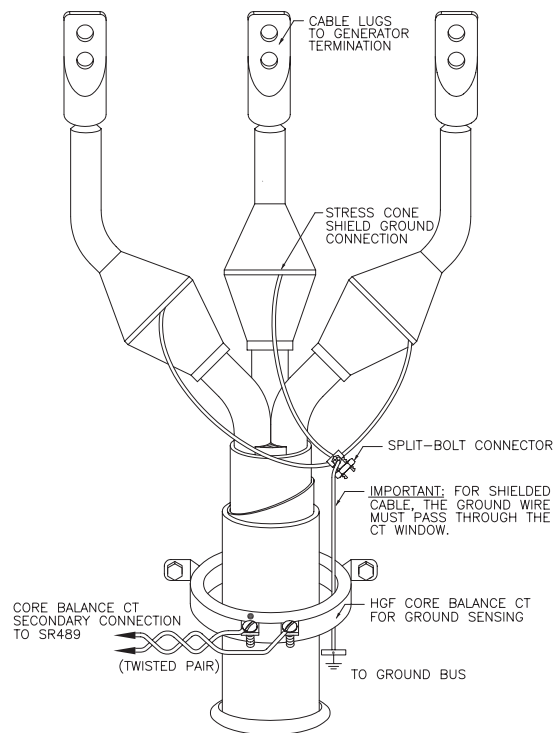

808788A1.DWG

Figure 2-13: CORE BALANCE GROUND CT INSTALLATION

2.2.6 VOLTAGE INPUTS

The 489 has four voltage transformer inputs, three for generator terminal voltage and one for neutral voltage. There are no internal fuses or ground connections on the voltage inputs. The maximum VT ratio is 240.00:1. The two possible VT connections for generator terminal voltage measurement are open delta or wye (see Figure 2–9: TYPICAL WIRING DIAGRAM on page 2–7). The voltage channels are connected in wye internally, which means that the jumper shown on the delta-source connection of the TYPICAL WIRING DIAGRAM, between the phase B input and the 489 neutral terminal, must be installed for open delta VTs.



Polarity of the generator terminal VTs is critical for correct power measurement and voltage phase reversal operation.

2.2.7 DIGITAL INPUTS



There are 9 digital inputs that are designed for dry contact connections only. Two of the digital inputs, Access and Breaker Status have their own common terminal, the balance of the digital inputs share one common terminal (see Figure 2–9: TYPICAL WIRING DIAGRAM on page 2–7).

In addition, the +24 V DC switch supply is brought out for control power of an inductive or capacitive proximity probe. The NPN transistor output could be taken to one of the assignable digital inputs configured as a counter or tachometer. Refer to the Specifications section of this manual for maximum current draw from the +24 V DC switch supply.



DO NOT INJECT VOLTAGES TO DIGITAL INPUTS. DRY CONTACT CONNECTIONS ONLY.

2.2.8 ANALOG INPUTS

Terminals are provided on the 489 for the input of four 0 to 1 mA, 0 to 20 mA, or 4 to 20 mA current signals (field programmable). This current signal can be used to monitor any external quantity such as: vibration, pressure, field current, etc. The four inputs share one common return. Polarity of these inputs must be observed for proper operation. The analog input circuitry is isolated as a group with the Analog Output circuitry and the RTD circuitry. Only one ground reference should be used for the three circuits. Transorbs limit this isolation to ±36 V with respect to the 489 safety ground.

In addition, the +24 V DC analog input supply is brought out for control power of loop powered transducers. Refer to the Specifications section of this manual for maximum current draw from this supply.

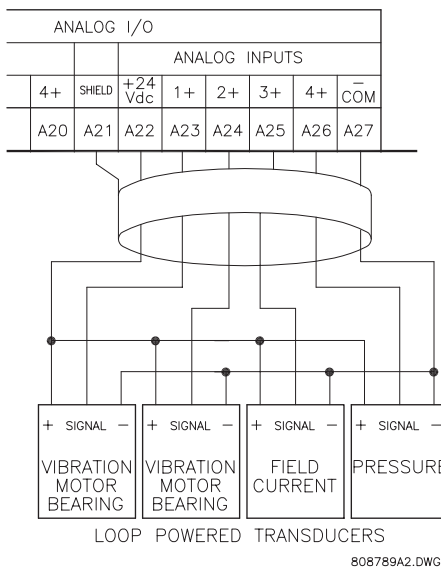

Figure 2–14: LOOP POWERED TRANSDUCER CONNECTION

2.2.9 ANALOG OUTPUTS

The 489 provides four analog output channels, which when ordering, are selected to provide a full-scale range of either 0 to 1 mA (into a maximum 10 kΩ impedance), or 4 to 20 mA (into a maximum 600 Ω impedance). Each channel can be configured to provide full-scale output sensitivity for any range of any measured parameter.

As shown in Figure 2–9: TYPICAL WIRING DIAGRAM on page 2–7, these outputs share one common return. The polarity of these outputs must be observed for proper operation. Shielded cable should be used, with only one end of the shield grounded, to minimize noise effects.

The analog output circuitry is isolated as a group with the Analog Input circuitry and the RTD circuitry. Only one ground reference should be used for the three circuits. Transorbs limit this isolation to ±36 V with respect to the 489 safety ground.

If a voltage output is required, a burden resistor must be connected at the input of the SCADA measuring device. Ignoring the input impedance of the input:

$$R_{LOAD} = \frac{V_{FULL-SCALE}}{I_{MAX}}$$

For example, for a 0 to 1 mA input, if 5 V full scale corresponds to 1 mA, then $R_{LOAD} = 5 \text{ V} / 0.001 \text{ A} = 5000 \text{ } \Omega$. For a 4 to 20 mA input, this resistor would be $R_{LOAD} = 5 \text{ V} / 0.020 \text{ A} = 250 \text{ } \Omega$.

2.2.10 RTD SENSOR CONNECTIONS

The 489 can monitor up to 12 RTD inputs for Stator, Bearing, Ambient, or Other temperature monitoring. The type of each RTD is field programmable as: 100 Ω Platinum (DIN 43760), 100 Ω Nickel, 120 Ω Nickel, or 10 Ω Copper. RTDs must be three wire type. Every two RTDs shares a common return.

The 489 RTD circuitry compensates for lead resistance, provided that each of the three leads is the same length. Lead resistance should not exceed 25 Ω per lead. Shielded cable should be used to prevent noise pickup in the industrial environment. RTD cables should be kept close to grounded metal casings and avoid areas of high electromagnetic or radio interference. RTD leads should not be run adjacent to or in the same conduit as high current carrying wires.

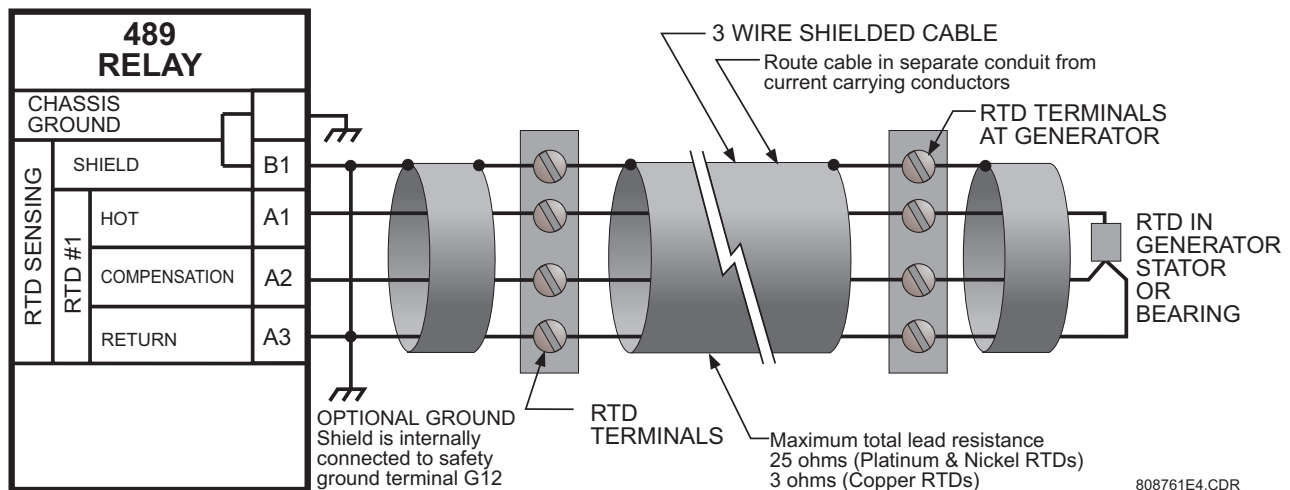

Figure 2–15: RTD WIRING



IMPORTANT NOTE: The RTD circuitry is isolated as a group with the Analog Input circuitry and the Analog Output circuitry. Only one ground reference should be used for the three circuits. Transorbs limit this isolation to ±36 V with respect to the 489 safety ground. If code requires that the RTDs be grounded locally at the generator terminal box, that will also be the ground reference for the analog inputs and outputs.

2.2.11 OUTPUT RELAYS

There are six Form C output relays (see the SPECIFICATIONS for ratings). Five of the six relays are always non-failsafe, R6 Service is always failsafe. As failsafe, R6 relay will be energized normally and de-energize when called upon to operate. It will also de-energize when control power to the 489 is lost and therefore, be in its operated state. All other relays, being non-failsafe, will be de-energized normally and energize when called upon to operate. Obviously, when control power is lost to the 489, these relays must be de-energized and therefore, they will be in their non-operated state. Shorting bars in the drawout case ensure that when the 489 is drawn out, no trip or alarm occurs. The R6 Service output will however indicate that the 489 has been drawn out. Each output relay has an LED indicator on the 489 front panel that comes on while the associated relay is in the operated state.

- **R1 TRIP:** The trip relay should be wired such that the generator is taken offline when conditions warrant. For a breaker application, the NO R1 Trip contact should be wired in series with the Breaker trip coil.

Supervision of a breaker trip coil requires that the supervision circuit be paralleled with the R1 TRIP relay output contacts, as shown in Figure 2–9: TYPICAL WIRING DIAGRAM on page 2–7. With this connection made, the supervision input circuits will place an impedance across the contacts that will draw a current of 2 to 5 mA (for an external supply voltage from 30 to 250 V DC) through the breaker trip coil. The supervision circuits respond to a loss of this trickle current as a failure condition. Circuit breakers equipped with standard control circuits have a breaker auxiliary contact permitting the trip coil to be energized only when the breaker is closed. When these contacts are open, as detected by the Breaker Status digital input, trip coil supervision circuit is automatically disabled. This logic provides that the trip circuit is monitored only when the breaker is closed.

- **R2 AUXILIARY, R3 AUXILIARY, R4 AUXILIARY:** The auxiliary relays may be programmed for numerous functions such as, trip echo, alarm echo, trip backup, alarm or trip differentiation, control circuitry, etc. They should be wired as configuration warrants.
- **R5 ALARM:** The alarm relay should connect to the appropriate annunciator or monitoring device.
- **R6 SERVICE:** The service relay will operate if any of the 489 diagnostics detect an internal failure or on loss of control power. This output may be monitored with an annunciator, PLC or DCS.

The service relay NC contact may also be wired in parallel with the trip relay on a breaker application. This will provide failsafe operation of the generator; that is, the generator will be tripped offline in the event that the 489 is not protecting it. Simple annunciation of such a failure will allow the operator or the operation computer to either continue, or do a sequenced shutdown.



Relay contacts must be considered unsafe to touch when the system is energized! If the customer requires the relay contacts for low voltage accessible applications, it is their responsibility to ensure proper insulation levels.

2.2.12 IRIG-B

IRIG-B is a standard time-code format that allows stamping of events to be synchronized among connected devices within 1 millisecond. The IRIG-B time codes are serial, width-modulated formats which are either DC level shifted or amplitude modulated (AM). Third party equipment is available for generating the IRIG-B signal. This equipment may use a GPS satellite system to obtain the time reference enabling devices at different geographic locations to be synchronized.

Terminals E12 and F12 on the 489 unit are provided for the connection of an IRIG-B signal.

2.2.13 RS485 COMMUNICATIONS PORTS

2

Two independent two-wire RS485 ports are provided. Up to 32 489 relays can be daisy-chained together on a communication channel without exceeding the driver capability. For larger systems, additional serial channels must be added. It is also possible to use commercially available repeaters to increase the number of relays on a single channel to more than 32. A suitable cable should have a characteristic impedance of 120 Ω (e.g. Belden #9841) and total wire length should not exceed 4000 feet (approximately 1200 metres). Commercially available repeaters will allow for transmission distances greater than 4000 ft.

Voltage differences between remote ends of the communication link are not uncommon. For this reason, surge protection devices are internally installed across all RS485 terminals. Internally, an isolated power supply with an optocoupled data interface is used to prevent noise coupling.



To ensure that all devices in a daisy-chain are at the same potential, it is imperative that the common terminals of each RS485 port are tied together and grounded only once, at the master. Failure to do so may result in intermittent or failed communications.

The source computer/PLC/SCADA system should have similar transient protection devices installed, either internally or externally, to ensure maximum reliability. Ground the shield at one point only, as shown below, to avoid ground loops.

Correct polarity is also essential. All 489s must be wired with all '+' terminals connected together, and all '-' terminals connected together. Each relay must be daisy-chained to the next one. Avoid star or stub connected configurations. The last device at each end of the daisy chain should be terminated with a 120 Ω ¼ W resistor in series with a 1 nF capacitor across the '+' and '-' terminals. Observing these guidelines will result in a reliable communication system that is immune to system transients.

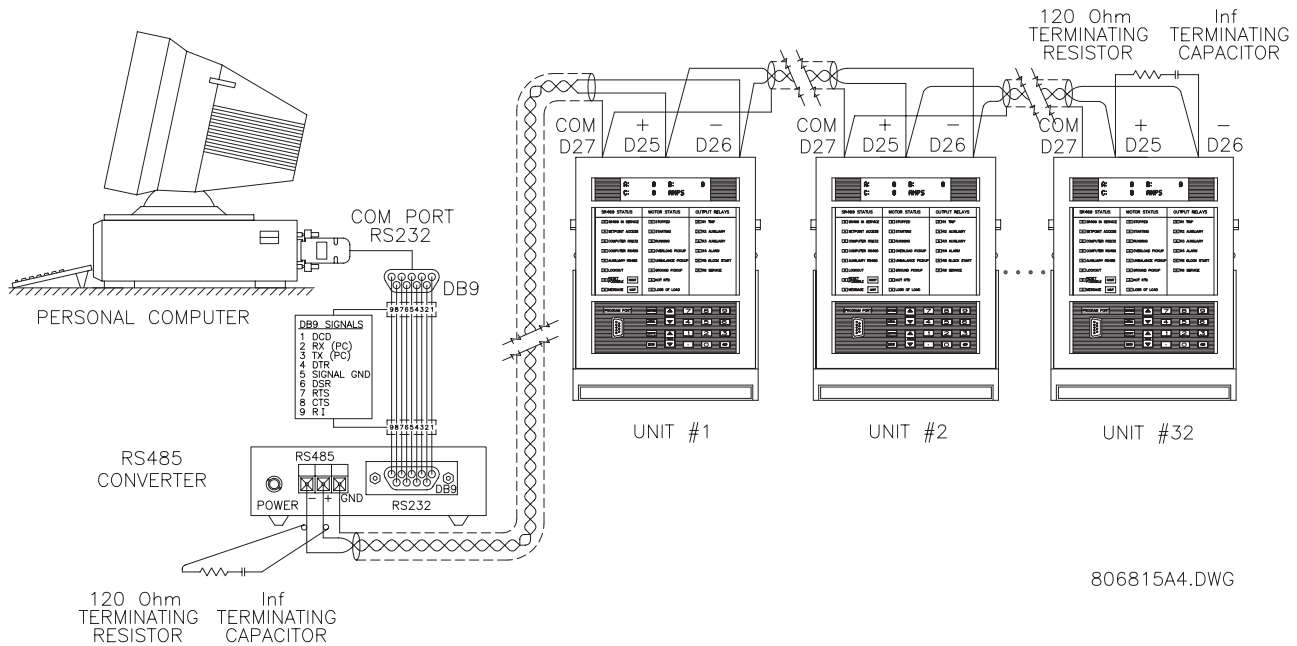

Figure 2-16: RS485 COMMUNICATIONS INTERFACE

2.2.14 DIELECTRIC STRENGTH TESTING

It may be required to test for dielectric strength (“flash” or hi-pot”) with the 489 installed. The 489 is rated for 2000 V DC isolation between relay contacts, CT inputs, VT inputs, trip coil supervision, and the safety ground terminal G12. Some precautions are required to prevent 489 damage during these tests.

Filter networks and transient protection clamps are used between control power, trip coil supervision, and the filter ground terminal G11. This filtering is intended to filter out high voltage transients, radio frequency interference (RFI), and electromagnetic interference (EMI). The filter capacitors and transient suppressors could be damaged by application continuous high voltage. Disconnect filter ground terminal G11 during testing of control power and trip coil supervision. CT inputs, VT inputs, and output relays do not require any special precautions. Low voltage inputs (<30 V), RTDs, analog inputs, analog outputs, digital inputs, and RS485 communication ports are not to be tested for dielectric strength under any circumstance (see below).

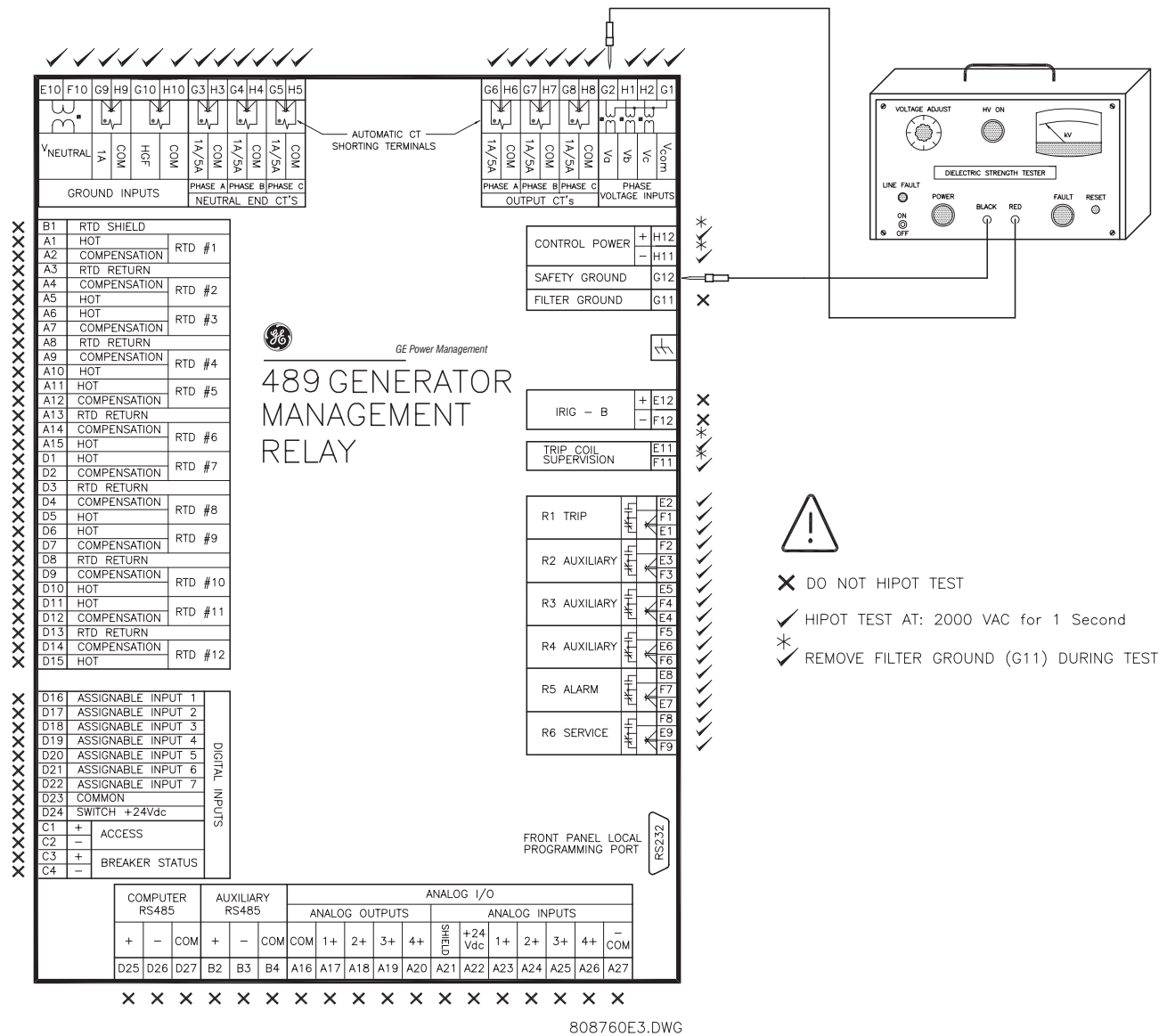
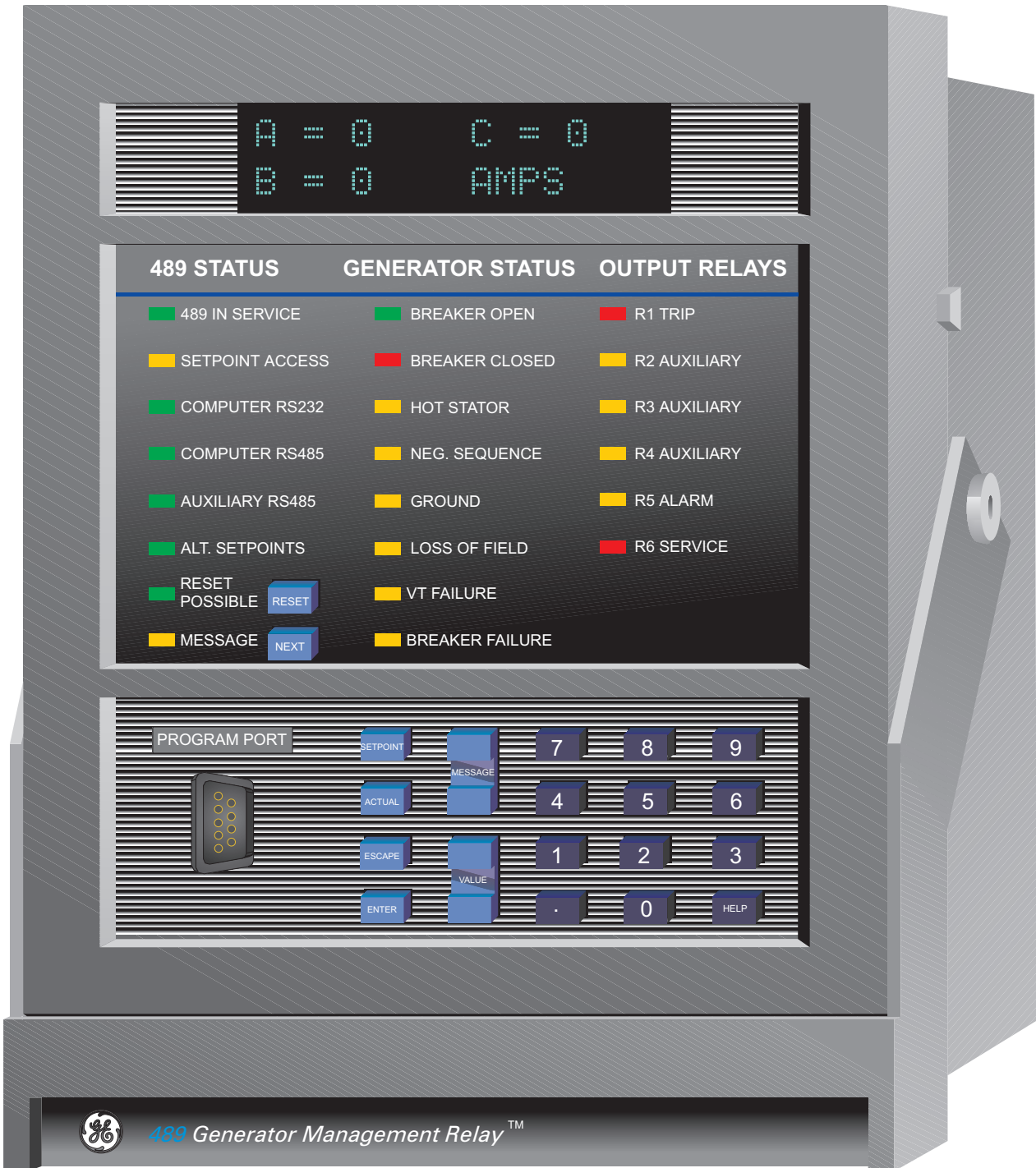

Figure 2-17: TESTING THE 489 FOR DIELECTRIC STRENGTH

2



3

Figure 3–1: 489 FACEPLATE

808754E3.CDR

3.1.2 DISPLAY

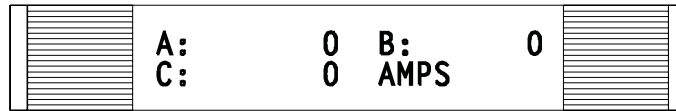

Figure 3-2: 489 DISPLAY

All messages appear on a 40-character vacuum fluorescent display for visibility under poor lighting conditions. Messages are in plain English and do not require the aid of an instruction manual for deciphering. When the user interface is not being used, the display defaults to the user-defined status messages. Any trip or alarm automatically overrides the default messages and is immediately displayed.

Press the **HELP** key for 2 seconds to initiate a lamp test.

3

3.1.3 LED INDICATORS

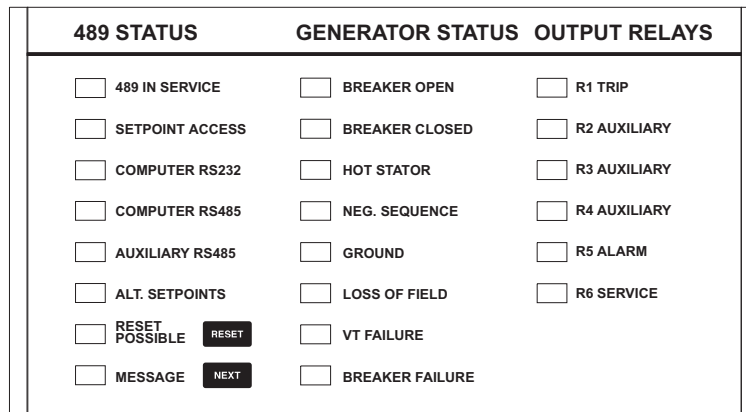

Figure 3-3: 489 LED INDICATORS

There are three groups of LED indicators: 489 STATUS, GENERATOR STATUS, and OUTPUT RELAYS.

a) 489 STATUS LED INDICATORS

- **489 IN SERVICE:** Indicates that control power is applied, all monitored input/output and internal systems are OK, the 489 has been programmed, and is in protection mode, not simulation mode. When in simulation or testing mode, the LED indicator will flash.
- **SETPOINT ACCESS:** Indicates that the access jumper is installed and passcode protection has been satisfied. Setpoints may be altered and stored.
- **COMPUTER RS232:** Flashes when there is any activity on the RS232 communications port. Remains on continuously if incoming data is valid.
- **COMPUTER RS485:** Flashes when there is any activity on the RS485 communications port. Remains on continuously if incoming data is valid and intended for the slave address programmed in the relay.
- **AUXILIARY RS485:** Flashes when there is any activity on the communications port. Remains on continuously if incoming data is valid and intended for the slave address programmed in the relay.
- **ALT. SETPOINTS:** Flashes when the alternate setpoint group is being edited and the primary setpoint group is active. Remains on continuously if the alternate setpoint group is active. The alternate setpoint group feature is enabled as one of the assignable digital inputs. The alternate setpoints group can be selected by setting the **S3 DIGITAL INPUTS / DUAL SETPOINTS / ACTIVATE SETPOINT GROUP** setpoint to "Group 2".
- **RESET POSSIBLE:** A trip or latched alarm may be reset. Pressing the **RESET** key clears the trip/alarm.
- **MESSAGE:** Indicator flashes when a trip or alarm occurs. Press the **NEXT** key to scroll through the diagnostic messages. Remains solid when setpoint and actual value messages are being viewed. Pressing the **NEXT** key returns the display to the default messages.

b) GENERATOR STATUS LED INDICATORS

- **BREAKER OPEN:** Uses the breaker status input signal to indicate that the breaker is open and the generator is offline.
- **BREAKER CLOSED:** Uses the breaker status input signal to indicate that the breaker is closed and the generator is online.
- **HOT STATOR:** Indicates that the generator stator is above normal temperature when one of the stator RTD alarm or trip elements is picked up or the thermal capacity alarm element is picked up.
- **NEG. SEQUENCE:** Indicates that the negative sequence current alarm or trip element is picked up.
- **GROUND:** Indicates that at least one of the ground overcurrent, neutral overvoltage (fundamental), or neutral under-voltage (3rd harmonic) alarm/trip elements is picked up.
- **LOSS OF FIELD:** Indicates that at least one of the reactive power (kvar) or field-breaker discrepancy alarm/trip elements is picked up.
- **VT FAILURE:** Indicates that the VT fuse failure alarm is picked up.
- **BREAKER FAILURE:** Indicates that the breaker failure or trip coil monitor alarm is picked up.

c) OUTPUT RELAY LED INDICATORS

- **R1 TRIP:** R1 Trip relay has operated (energized).
- **R2 AUXILIARY:** R2 Auxiliary relay has operated (energized).
- **R3 AUXILIARY:** R3 Auxiliary relay has operated (energized).
- **R4 AUXILIARY:** R4 Auxiliary relay has operated (energized).
- **R5 ALARM:** R5 Alarm relay has operated (energized).
- **R6 SERVICE:** R6 Service relay has operated (de-energized, R6 is fail-safe, normally energized).

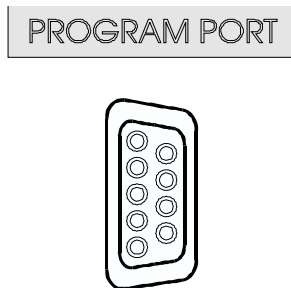
3.1.4 RS232 PROGRAM PORT**Figure 3–4: RS232 PROGRAM PORT**

This port is intended for connection to a portable PC. Setpoint files may be created at any location and downloaded through this port with the 489PC software. Local interrogation of setpoints and actual values is also possible. New firmware may be downloaded to the 489 flash memory through this port. Upgrading the relay firmware does not require a hardware EEPROM change.

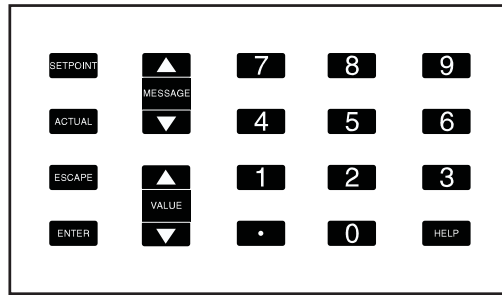



Figure 3-5: 489 KEYPAD



3

The 489 messages are organized into pages under the headings **SETPOINTS** and **ACTUAL VALUES**. The **SETPOINT** key navigates through the programmable parameters (setpoints) page headers. The **ACTUAL** key navigates through the measured parameters (actual values) page headers.

Each page is divided into logical subgroups of messages. The **MESSAGE**  and **MESSAGE**  keys are used to navigate through these subgroups.

The **ENTER** key is dual purpose. It is used to enter the subgroups or store altered setpoint values.

The **ESCAPE** key is also dual purpose. It may be used to exit the subgroups or to return an altered setpoint to its original value before it has been stored.



The **VALUE**  and **VALUE**  keys scroll through variables in setpoint programming mode and will increment/decrement numerical setpoint values. These values may also be entered with the numeric keypad.

The **HELP** key may be pressed at any time for context sensitive help messages.

3.1.6 ENTERING ALPHANUMERIC TEXT





To customize the 489 for specific applications, there are several places where custom text messages may be programmed. One example is the **MESSAGE SCRATCHPAD**. The following example demonstrates how to enter alphanumeric text messages.

For example, to enter the text, "Generator#1"

1. Press the decimal key [.] to enter text edit mode.
2. Press the **VALUE**  or **VALUE**  key until "G" appears, then press the decimal key to advance the cursor to the next position.
3. Repeat step 2 for the remaining characters: e, n, e, r, a, t, o, r, #, and 1.
4. Press **ENTER** to store the text message.

3.1.7 ENTERING +/- SIGNS

The 489 does not have a '+' or '-' key. Negative numbers may be entered in one of the following two ways:

- Press the **VALUE**  or **VALUE**  keys the scroll through the setpoint range, including any negative numbers.
- Once a numeric setpoint is entered (after pressing at least one numeric key), press the **VALUE**  or **VALUE**  key to change the sign, if applicable.

3.2.1 PROCEDURE

To store setpoints from the front panel keypad, terminals C1 and C2 (access terminals) must be shorted (a key switch may be used for security). There is also a setpoint passcode feature that can restrict setpoint access from the keypad and communication ports. If activated, the passcode must be entered before changing the setpoint values. A passcode of 0 turns off the passcode feature and only the access jumper is required to change setpoints. If no setpoint changes are made for 30 minutes, access to setpoint values will be restricted until the passcode is entered again. To prevent setpoint access before the 30 minutes expiry, the unit may be turned off and back on, the access jumper may be removed, or the **SETPOINT ACCESS** setpoint may be changed to Restricted. The passcode for the front panel keypad cannot be entered until terminals C1 and C2 are shorted. The SETPOINT ACCESS indicator will be on if setpoint access is enabled for the front panel keypad.

The following procedure may be used to access and alter any setpoint message. This specific example will refer to entering a valid passcode in order to allow access to setpoints if the passcode was '489'.

1. The 489 programming is broken down into pages by logical groups. Press **SETPOINT** to cycle through the setpoint pages until the desired page appears on the screen. Press **MESSAGE** to enter a page.

```
|| SETPOINTS
|| S1 489 SETUP
```

2. Each page is broken further into subgroups. Press the **MESSAGE** and **MESSAGE** keys to cycle through subgroups until the desired subgroup appears on the screen. Press **ENTER** to enter a subgroup.

```
| PASSCODE
| [ENTER] for more
```

3. Each sub-group has one or more associated setpoint messages. Press the **MESSAGE** and **MESSAGE** keys to cycle through setpoint messages until the desired setpoint message appears on the screen.

```
ENTER PASSCODE FOR
ACCESS:
```

4. The majority of setpoints may be altered by pressing the **VALUE** and **VALUE** keys until the desired value appears then pressing **ENTER**. Numeric setpoints may also be entered directly through the keypad. If an entered setpoint value is out of range, the original setpoint value reappears. If an out-of-step setpoint is entered, an adjusted value is stored (e.g. a value of 101 for a setpoint that steps 95, 100, 105 is stored as 100). If a mistake is made entering the new value, pressing **ESCAPE** resets the setpoint to its original value. Text editing is described in detail in Section 3.1.6: ENTERING ALPHANUMERIC TEXT on page 3–4. When a new setpoint is successfully stored, the **NEW SETPOINT HAS BEEN STORED** message flashes on the display.
5. Press the **4**, **8**, and **9** keys, then press **ESCAPE**. The following flash message is briefly displayed:

```
NEW SETPOINT HAS
BEEN STORED
```

and the display returns to:

```
SETPOINT ACCESS:
PERMITTED
```

6. Press **ESCAPE** to exit the subgroup. Pressing **ESCAPE** numerous times always brings the cursor to the top of the page.

3

4.1.1 TRIPS / ALARMS / CONTROL FEATURES DEFINED

The 489 Generator Management Relay has three basic function categories: TRIPS, ALARMS, and CONTROL.

a) TRIPS

A 489 trip feature may be assigned to any combination of the four output relays: R1 Trip Relay, R2 Auxiliary, R3 Auxiliary, and R4 Auxiliary. If a Trip becomes active, the appropriate LED (indicator) on the 489 faceplate illuminates to indicate which output relay has operated. Each trip feature may be programmed as *latched* or *unlatched*. Once a latched trip feature becomes active, the **RESET** key must be pressed to reset that trip. If the condition that caused the trip is still present (for example, hot RTD) the trip relay(s) will not reset until the condition disappears. On the other hand, if an unlatched trip feature becomes active, that trip resets itself (and associated output relay(s)) after the condition that caused the trip ceases and the Breaker Status input indicates that the breaker is open. If there is a lockout time, the trip relay(s) will not reset until the lockout time has expired. Immediately prior to issuing a trip, the 489 takes a snapshot of generator parameters and stores them as pre-trip values, allowing for troubleshooting after the trip. The cause of last trip message is updated with the current trip and the 489 display defaults to that message. All trip features are automatically logged and date and time stamped as they occur. In addition, all trips are counted and logged as statistics such that any long term trends may be identified.



Lockout time will occur due to overload trip (see Section 4.10.2: MODEL SETUP on page 4–52 for details).

NOTE

b) ALARMS

A 489 alarm feature may be assigned to operate any combination of four output relays: R5 Alarm, R4 Auxiliary, R3 Auxiliary, and R2 Auxiliary. When an Alarm becomes active, the appropriate LED (indicator) on the 489 faceplate will illuminate when an output relay(s) has operated. Each alarm feature may be programmed as latched or unlatched. Once a latched alarm feature becomes active, the reset key must be pressed to reset that alarm. If the condition that has caused the alarm is still present (for example, hot RTD) the Alarm relay(s) will not reset until the condition is no longer present. If on the other hand, an unlatched alarm feature becomes active, that alarm will reset itself (and associated output relay(s)) as soon as the condition that caused the alarm ceases. As soon as an alarm occurs, the alarms messages are updated to reflect the alarm and the 489 display defaults to that message. Since it may not be desirable to log all alarms as events, each alarm feature may be programmed to log as an event or not. If an alarm is programmed to log as an event, when it becomes active, it is automatically logged as a date and time stamped event.

c) CONTROL

A 489 control feature may be assigned to operate any combination of five output relays: R5 Alarm, R4 Auxiliary, R3 Auxiliary, and R2 Auxiliary, and R1 Trip. The combination of relays available for each function is determined by the suitability of each relay for that particular function. The appropriate LED (indicator) on the 489 faceplate will illuminate when an output relay(s) has been operated by a control function. Since it may not be desirable to log all control function as events, each control feature may be programmed to log as an event or not. If a control feature is programmed to log as an event, each control relay event is automatically logged with a date and time stamp.

4.1.2 RELAY ASSIGNMENT PRACTICES

There are six output relays. Five of the relays are always non-failsafe, the other (Service) is failsafe and dedicated to announce internal 489 faults (these faults include setpoint corruption, failed hardware components, loss of control power, etc.). The five remaining relays may be programmed for different types of features depending on what is required. One of the relays, R1 Trip, is intended to be used as a trip relay wired to the unit trip breaker. Another relay, R5 Alarm, is intended to be used as the main alarm relay. The three remaining relays, R2 Auxiliary, R3 Auxiliary, and R4 Auxiliary, are intended for special requirements.

When assigning features to R2, R3, and R4 it is a good idea to decide early on what is required since features that may be assigned may conflict. For example, if R2 is to be dedicated as a relay for sequential tripping, it cannot also be used to announce a specific alarm condition.

In order to ensure that conflicts in relay assignments do not occur, several precautions have been taken. All trips default to the R1 TRIP output relay and all alarms default to the R5 Alarm relay. It is recommended that relay assignments be reviewed once all the setpoints have been programmed.

4.1.3 DUAL SETPOINTS

The 489 has dual settings for the current, voltage, power, RTD, and thermal model protection elements (S5 to S9). These setpoints are organized in two groups: the main group (Group 1) and the alternate group (Group 2). Only one group of settings is active in the protection scheme at a time. The active group can be selected using the **ACTIVATE SETPOINT GROUP** setpoint or an assigned digital input in S3 Digital Inputs. The LED indicator on the faceplate of the 489 will indicate when the alternate setpoints are active in the protection scheme. Independently, the setpoints in either group can be viewed and/or edited using the **EDIT SETPOINT GROUP** setpoint. Headers for each setpoint message subgroup that has dual settings will be denoted by a superscript number indicating which setpoint group is being viewed or edited. Also, when a setpoint that has dual settings is stored, the flash message that appears will indicate which setpoint group setting has been changed.

If only one setting group is required, edit and activate only Group 1 (that is, do not assign a digital input to Dual Setpoints, and do not alter the **ACTIVATE SETPOINT GROUP** setpoint or **EDIT SETPOINT GROUP** setpoint in S3 DIGITAL INPUTS).

4.1.4 SETPOINT MESSAGE MAP

4

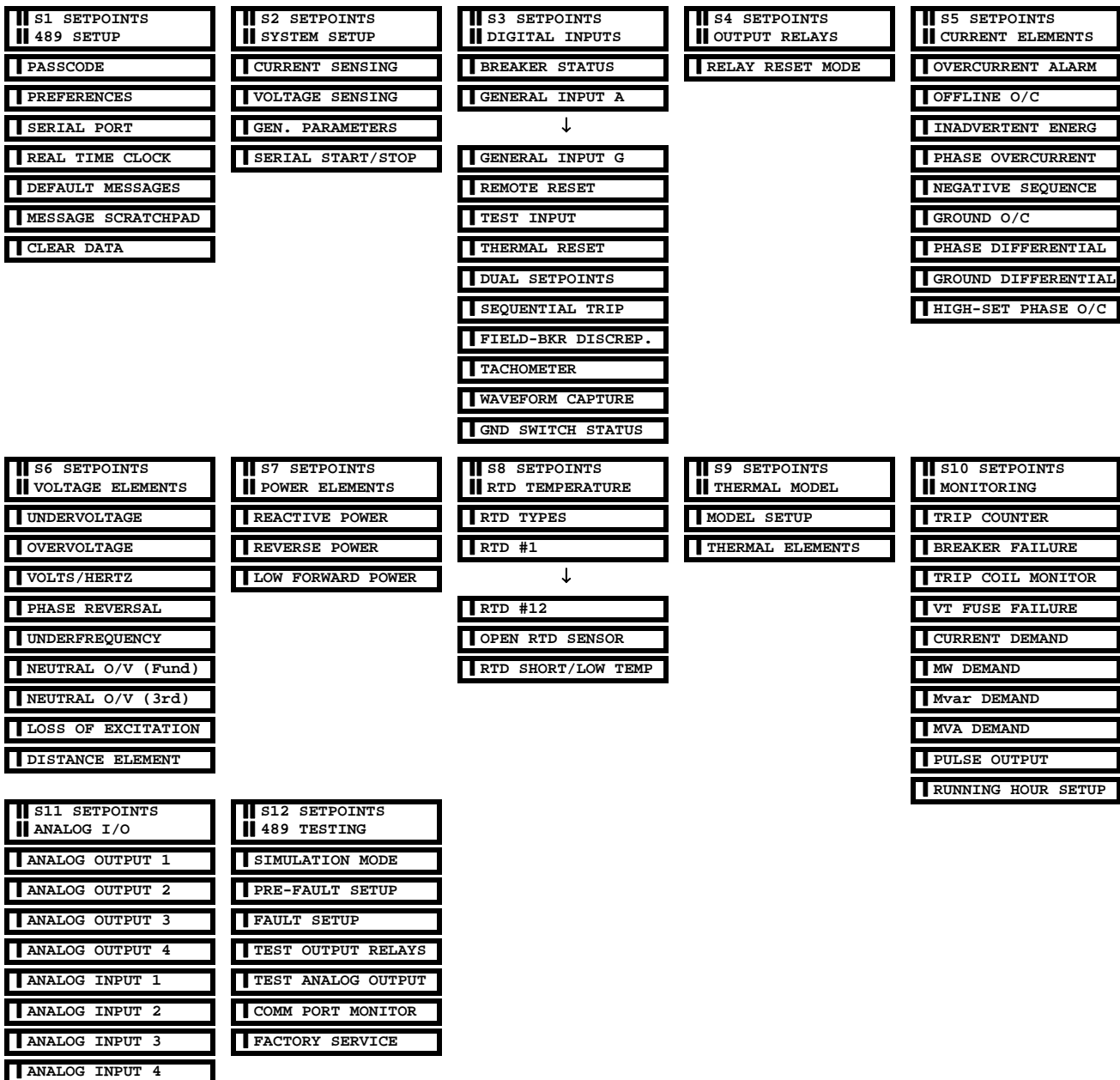

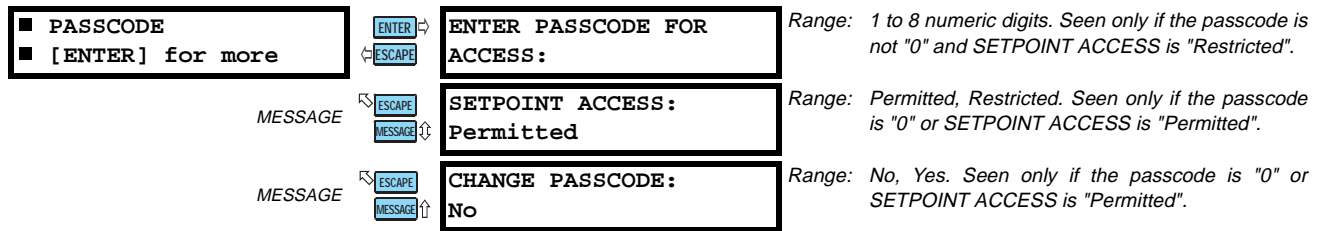

4.2.1 PASSCODE



A passcode access security feature is provided with the 489. The passcode is defaulted to "0" (without the quotes) at the time of shipping. Passcode protection is ignored when the passcode is "0". In this case, the setpoint access jumper is the only protection when programming setpoints from the front panel keypad and setpoints may be altered using the RS232 and RS485 serial ports without access protection. If however, the passcode is changed to a non-zero value, passcode protection is enabled. The access jumper must be installed and the passcode must be entered, to program setpoints from the front panel keypad. The passcode must also be entered individually from each serial communications port to gain setpoint programming access from that port.

To enable passcode protection on a new relay, follow the procedure below:

1. Press **ENTER** then MESSAGE  until the **CHANGE PASSCODE** message is displayed.
2. Select "Yes" and follow directions to enter a new passcode 1 to 8 digits in length.
3. Once a new passcode (other than 0) is programmed, it must be entered to gain setpoint access whenever setpoint access is restricted. Assuming that a non-zero passcode has been programmed and setpoint access is restricted, then selecting the passcode subgroup causes the **ENTER PASSCODE AGAIN** message to appear.
4. Enter the correct passcode. A flash message will advise if the code is incorrect and allow a retry. If it is correct and the setpoint access jumper is installed, the **SETPOINT ACCESS: Permitted** message appears.
5. Setpoints can now be entered. Exit the passcode message with the **ESCAPE** key and program the appropriate setpoints. If no keypress occurs for 5 minutes, access will be disabled and the passcode must be re-entered. Removing the setpoint access jumper or setting **SETPOINT ACCESS** to "Restricted" also disables setpoint access immediately.

If a new passcode is required, gain setpoint access by entering the current valid passcode. Press MESSAGE  to display the **CHANGE PASSCODE** message and follow the directions. If an invalid passcode is entered, the encrypted passcode is viewable by pressing **HELP**. Consult GE Power Management with this number if the currently programmed passcode is unknown. The passcode can be determined with deciphering software.

4.2.2 PREFERENCES

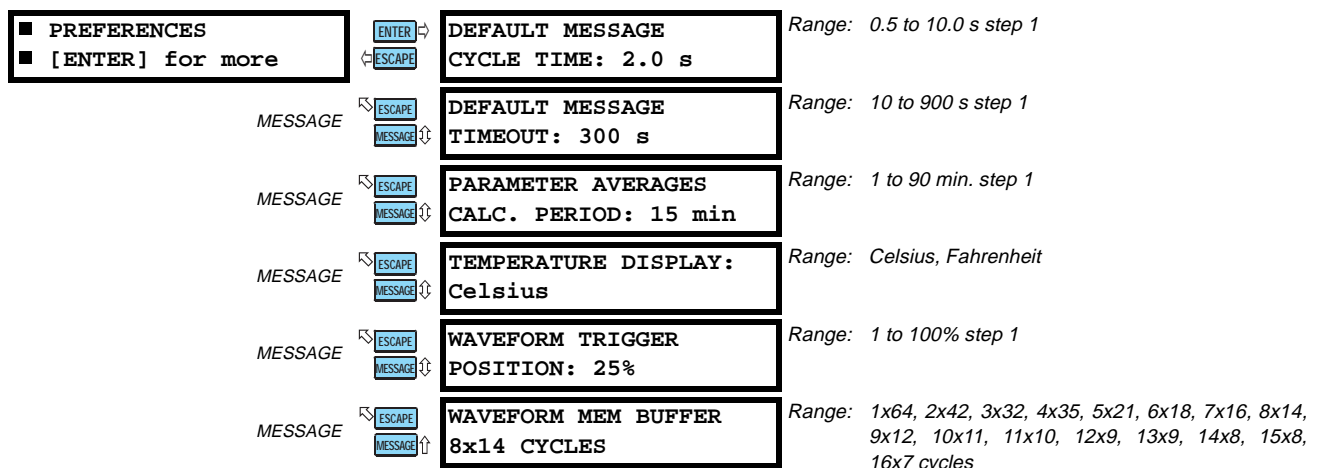

Some of the 489 characteristics can be modified to suit different situations. Normally the **S1 489 SETUP / PREFERENCES** setpoints group will not require any changes.

- **DEFAULT MESSAGE CYCLE TIME:** If multiple default messages are chosen, the display automatically cycles through these messages. The time the messages remain on the display can be changed to accommodate different reading rates.
- **DEFAULT MESSAGE TIMEOUT:** If no keys are pressed for a period of time then the relay automatically scans through a programmed set of default messages. This time can be modified to ensure messages remain on the screen long enough during programming or reading of actual values.
- **PARAMETER AVERAGES CALCULATION PERIOD:** The period of time over which the parameter averages are calculated may be adjusted with this setpoint. The calculation is a sliding window.
- **TEMPERATURE DISPLAY:** Measurements of temperature may be displayed in either Celsius or Fahrenheit. Each actual value temperature message will be denoted by either °C for Celsius or °F for Fahrenheit. RTD setpoints are always displayed in Celsius.
- **WAVEFORM TRIGGER:** The trigger setpoint allows the user to adjust how many pre-trip and post-trip cycles are stored in the waveform memory when a trip occurs. A value of 25%, for example, when the **WAVEFORM MEMORY BUFFER** is "7 x 16" cycles, would produce a waveform of 4 pre-trip cycles and 12 post-trip cycles.
- **WAVEFORM MEMORY BUFFER:** Selects the partitioning of the waveform memory. The first number indicates the number of events and the second number, the number of cycles. The relay captures 12 samples per cycle. When more waveform captures occur than the available storage, the oldest data will be discarded.

4.2.3 SERIAL PORTS

<ul style="list-style-type: none"> ■ SERIAL PORTS ■ [ENTER] for more 	[ENTER] → ← [ESCAPE]	SLAVE ADDRESS: 254	<i>Range: 1 to 254 step 1</i>
MESSAGE	↖ [ESCAPE] [MESSAGE] ⇅	COMPUTER RS485 BAUD RATE: 9600	<i>Range: 300, 1200, 2400, 4800, 9600, 19200</i>
MESSAGE	↖ [ESCAPE] [MESSAGE] ⇅	COMPUTER RS485 PARITY: None	<i>Range: None, Odd, Even</i>
MESSAGE	↖ [ESCAPE] [MESSAGE] ⇅	AUXILIARY RS485 BAUD RATE: 9600	<i>Range: 300, 1200, 2400, 4800, 9600, 19200</i>
MESSAGE	↖ [ESCAPE] [MESSAGE] ⇅	AUXILIARY RS485 PARITY: None	<i>Range: None, Odd, Even</i>
MESSAGE	↖ [ESCAPE] [MESSAGE] ⇅	PORT USED FOR DNP: None	<i>Range: None, Computer RS485, Auxiliary RS485, Front Panel RS232</i>
MESSAGE	↖ [ESCAPE] [MESSAGE] ⇅	DNP SLAVE ADDRESS: 255	<i>Range: 0 to 255 step 1</i>
MESSAGE	↖ [ESCAPE] [MESSAGE] ⇅	DNP TURNAROUND TIME: 10 ms	<i>Range: 0 to 100 ms step 10</i>

The 489 is equipped with 3 independent serial communications ports supporting a subset of Modbus RTU protocol. The front panel RS232 has a fixed baud rate of 9600 and a fixed data frame of 1 start/8 data/1 stop/no parity. The front port is intended for local use only and will respond regardless of the slave address programmed. The front panel RS232 program port may be connected to a personal computer running the 489PC software. This program may be used for downloading and uploading setpoint files, viewing measured parameters, and upgrading the 489 firmware to the latest revision.

For RS485 communications, each 489 must have a unique address from 1 to 254. Address 0 is the broadcast address which all relays listen to. Addresses do not have to be sequential but no two units can have the same address or conflicts resulting in errors will occur. Generally each unit added to the link will use the next higher address starting at 1. Baud rates can be selected as 300, 1200, 2400, 4800, 9600, or 19200. The data frame is fixed at 1 start, 8 data, and 1 stop bits, while parity is optional. The computer RS485 port is a general purpose port for connection to a DCS, PLC, or PC. The Auxiliary RS485 port may also be used as another general purpose port or it may be used to talk to Auxiliary GE Power Management Devices in the future.

4.2.4 REAL TIME CLOCK

<ul style="list-style-type: none"> ■ REAL TIME CLOCK ■ [ENTER] for more 	ENTER → ← ESCAPE	DATE (MM, DD, YYYY): 01/01/1995	Range: 01/01/1995 to 12/31/2094	
	MESSAGE ↻	ESCAPE ↻ MESSAGE ↻	TIME (HH.MM.SS): 12:00:00	Range: 00:00:00 to 23:59:59
	MESSAGE ↻	ESCAPE ↻ MESSAGE ↻	IRIG-B SIGNAL TYPE: NONE	Range: None, DC Shift, Amplitude Modulated

For events that are recorded by the event recorder to be correctly time/date stamped, the correct time and date must be entered. A battery backed internal clock runs continuously even when power is off. It has the same accuracy as an electronic watch approximately ±1 minute per month. It must be periodically corrected either manually through the front panel or via the clock update command over the RS485 serial link. If the approximate time an event occurred without synchronization to other relays is sufficient, then entry of time/date from the front panel keys is adequate.

If the RS485 serial communication link is used then all the relays can keep time in synchronization with each other. A new clock time is pre-loaded into the memory map via the RS485 communications port by a remote computer to each relay connected on the communications channel. The computer broadcasts (address 0) a "set clock" command to all relays. Then all relays in the system begin timing at the exact same instant. There can be up to 100 ms of delay in receiving serial commands so the clock time in each relay is ±100 ms, ± the absolute clock accuracy in the PLC or PC. See the chapter on Communications for information on programming the time preload and synchronizing commands.

An IRIG-B signal receiver may be connected to 489 units with hardware revision G or higher. The relay will continuously decode the time signal and set its internal time correspondingly. The "signal type" setpoint must be set to match the signal provided by the receiver.







4.2.5 DEFAULT MESSAGES

<ul style="list-style-type: none"> ■ DEFAULT MESSAGES ■ [ENTER] for more 	ENTER → ← ESCAPE	GENERATOR STATUS: Stopped	Range: N/A	
	MESSAGE ↻	ESCAPE ↻ MESSAGE ↻	A: 0 B: 0 C: 0 Amps	Range: N/A
	MESSAGE ↻	ESCAPE ↻ MESSAGE ↻	Vab: 0 Vbc: 0 Vca: 0 Volts	Range: N/A
	MESSAGE ↻	ESCAPE ↻ MESSAGE ↻	FREQUENCY: 0.00 Hz	Range: N/A
	MESSAGE ↻	ESCAPE ↻ MESSAGE ↻	POWER FACTOR: 0.00	Range: N/A
	MESSAGE ↻	ESCAPE ↻ MESSAGE ↻	REAL POWER: 0 MW	Range: N/A
	MESSAGE ↻	ESCAPE ↻ MESSAGE ↻	REACTIVE POWER 0 Mvar	Range: N/A
	MESSAGE ↻	ESCAPE ↻ MESSAGE ↻	DATE: 01/01/1995 TIME: 12:00:00	Range: N/A
MESSAGE ↻	ESCAPE ↻ MESSAGE ↻	POWER MANAGEMENT 489 GENERATOR RELAY	Range: N/A	



The 489 displays default messages after a period of keypad inactivity. Up to 20 default messages can be selected for display. If more than one message is chosen, they will automatically scroll at a rate determined by the S1 489 SETUP / PREFERENCES / DEFAULT MESSAGE CYCLE TIME setpoint. Any actual value can be selected for display. In addition, up to 5

user-programmable messages can be created and displayed with the message scratchpad. For example, the relay could be set to alternately scan a generator identification message, the current in each phase, and the hottest stator RTD. Currently selected default messages can be viewed in **DEFAULT MESSAGES** subgroup.

Default messages can be added to the end of the default message list, as follows:

1. Enter the correct passcode at **S1 489 SETUP / PASSCODE / ENTER PASSCODE FOR ACCESS** to allow setpoint entry (unless it has already been entered or is "0", defeating the passcode security feature).
2. Select the message to be add to the default message list using the MESSAGE  and MESSAGE  keys. The selected message can be any Actual Value or Message Scratchpad message.
3. Press . The **PRESS [ENTER] TO ADD DEFAULT MESSAGES** message will be displayed for 5 seconds:
4. Press  again while this message is displayed to add the current message to the end of the default message list.
5. If the procedure was followed correctly, the **DEFAULT MESSAGE HAS BEEN ADDED** flash message is displayed:
6. To verify that the message was added, view the last message under the **S1 489 SETUP / DEFAULT MESSAGES** menu.



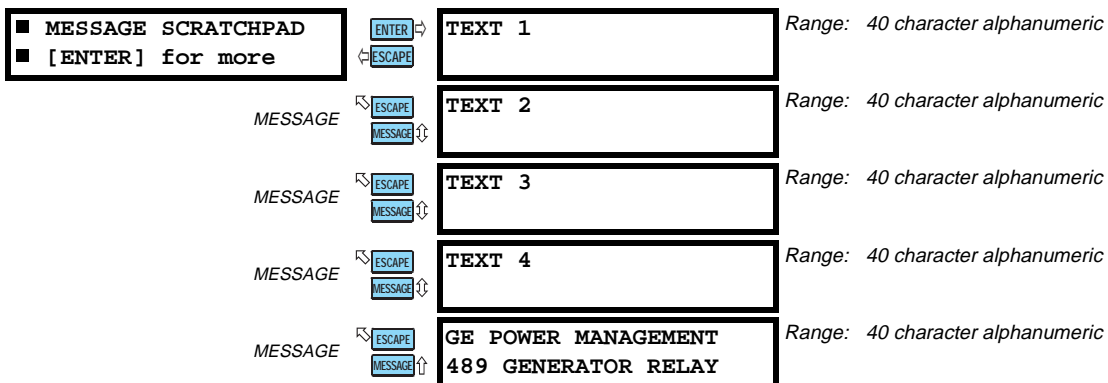

Default messages can be removed from the default message list, as follows:

1. Enter the correct passcode at **S1 489 SETUP / PASSCODE / ENTER PASSCODE FOR ACCESS** to allow setpoint entry (unless the passcode has already been entered or unless the passcode is "0" defeating the passcode security feature).
2. Select the message to be removed from the default message list under the **S1 489 SETUP / DEFAULT MESSAGES** menu.
3. Select the default message to remove and press . The relay will display **PRESS [ENTER] TO REMOVE MESSAGE**.
4. Press  while this message is displayed to remove the current message out of the default message list.
5. If the procedure was followed correctly, the relay will display the **DEFAULT MESSAGE HAS BEEN REVOKED** flash message.

4.2.6 MESSAGE SCRATCHPAD



Up to 5 message screens can be programmed under the Message Scratchpad area. These messages may be notes that pertain to the installation of the generator. In addition, these notes may be selected for scanning during default message display. This might be useful for reminding operators to perform certain tasks. The messages may be entered from the communications ports or through the keypad. To enter a 40 character message:

1. Select the user message to be changed
2. Press the decimal [.] key to enter text mode. An underscore cursor will appear under the first character.
3. Use the VALUE  and VALUE  keys to display the desired character. A space is selected like a character.
4. Press the [.] key to advance to the next character. To skip over a character press the [.] key. If an incorrect character is accidentally stored, press the [.] key enough times to scroll the cursor around to the character.
5. When the desired message is displayed press the  key to store or the  key to abort. The message is now permanently stored. Press  to cancel the altered message.

4.2.7 CLEAR DATA

<ul style="list-style-type: none"> ■ CLEAR DATA ■ [ENTER] for more 	<div style="border: 1px solid black; padding: 2px; display: inline-block;">ENTER</div> →	CLEAR LAST TRIP DATA: No	Range: No, Yes
MESSAGE	<div style="border: 1px solid black; padding: 2px; display: inline-block;">ESCAPE</div> ↵	RESET MWh and Mvarh METERS: No	Range: No, Yes
MESSAGE	<div style="border: 1px solid black; padding: 2px; display: inline-block;">ESCAPE</div> ↵	CLEAR PEAK DEMAND DATA: No	Range: No, Yes
MESSAGE	<div style="border: 1px solid black; padding: 2px; display: inline-block;">ESCAPE</div> ↵	CLEAR RTD MAXIMUMS: No	Range: No, Yes
MESSAGE	<div style="border: 1px solid black; padding: 2px; display: inline-block;">ESCAPE</div> ↵	CLEAR ANALOG I/P MIN/MAX: No	Range: No, Yes
MESSAGE	<div style="border: 1px solid black; padding: 2px; display: inline-block;">ESCAPE</div> ↵	CLEAR TRIP COUNTERS: No	Range: No, Yes
MESSAGE	<div style="border: 1px solid black; padding: 2px; display: inline-block;">ESCAPE</div> ↵	CLEAR EVENT RECORD: No	Range: No, Yes
MESSAGE	<div style="border: 1px solid black; padding: 2px; display: inline-block;">ESCAPE</div> ↵	CLEAR GENERATOR INFORMATION: No	Range: No, Yes
MESSAGE	<div style="border: 1px solid black; padding: 2px; display: inline-block;">ESCAPE</div> ↵	CLEAR BREAKER INFORMATION: No	Range: No, Yes

These commands may be used to clear various historical data.

- **CLEAR LAST TRIP DATA:** The Last Trip Data may be cleared by executing this command.
- **CLEAR MWh and Mvarh METERS:** Executing this command will clear the MWh and Mvarh metering to zero.
- **CLEAR PEAK DEMAND DATA:** Execute this command to clear peak demand values.
- **CLEAR RTD MAXIMUMS:** All maximum RTD temperature measurements are stored and updated each time a new maximum temperature is established. Execute this command to clear the maximum values.
- **CLEAR ANALOG I/P MIN/MAX:** The minimum and maximum analog input values are stored for each Analog Input. Those minimum and maximum values may be cleared at any time.
- **CLEAR TRIP COUNTERS:** There are counters for each possible type of trip. Those counters may be cleared by executing this command.
- **CLEAR EVENT RECORD:** The event recorder saves the last 40 events, automatically overwriting the oldest event. If desired, all events can be cleared using this command to prevent confusion with old information.
- **CLEAR GENERATOR INFORMATION:** The number of thermal resets and the total generator running hours can be viewed in actual values. On a new installation, or if new equipment is installed, this information is cleared through this setpoint.
- **CLEAR BREAKER INFORMATION:** The total number of breaker operations can be viewed in actual values. On a new installation or if maintenance work is done on the breaker, this accumulator can be cleared with this setpoint.

4.3.1 CURRENT SENSING

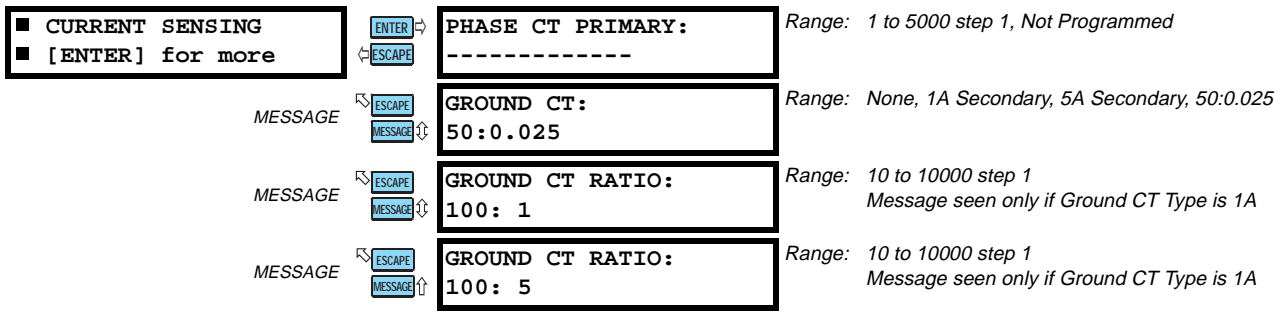

As a safeguard, the **PHASE CT PRIMARY** and Generator Parameters setpoints are defaulted to "-----" (indicating not programmed) when shipped from the factory. The 489 will indicate that it was never programmed. Once these values are entered, the 489 will be in service. The phase CT should be selected such that the maximum fault current does not exceed 20 times the primary rating. When relaying class CTs are purchased, this precaution will help prevent CT saturation under fault conditions. The secondary value of 1 or 5 A **must** be specified when ordering so the proper hardware will be installed. The **PHASE CT PRIMARY** setpoint applies to both the neutral end CTs as well as the output CTs.

4

For high resistance grounded systems, sensitive ground current detection is possible if the 50:0.025 ground CT is used. To use the 50:0.025 ground CT input, select 50:0.025 for the **GROUND CT** setpoint. No additional ground CT messages will appear. On solid or low resistance grounded systems, where fault currents may be quite large, the 489 1 A/5 A secondary ground CT input should be used. The Ground CT primary should be selected such that potential fault current does not exceed 20 times the primary rating. When relaying class CTs are purchased, this precaution will ensure that the Ground CT does not saturate under fault conditions.



The 489 uses a nominal CT primary rating of 5 A for calculation of pickup levels.

4.3.2 VOLTAGE SENSING

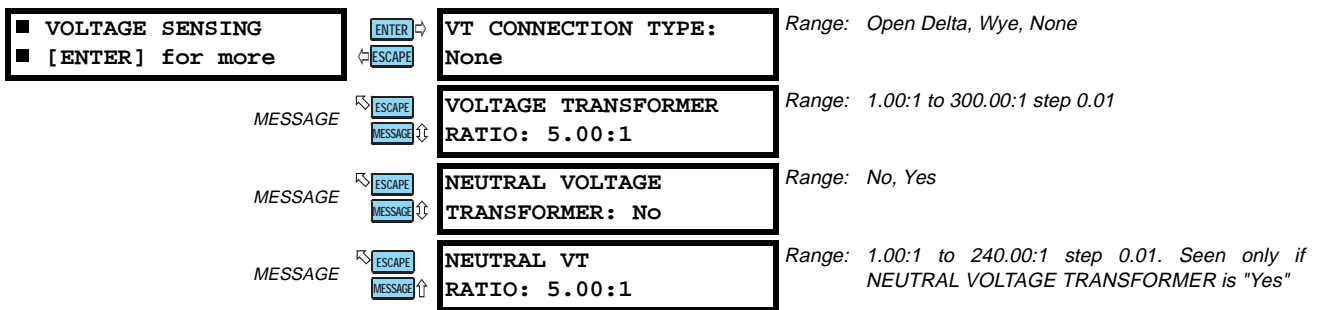

The voltage transformer connections and turns ratio are entered here. The VT should be selected such that the secondary phase-phase voltage of the VTs is between 70.0 and 135.0 V when the primary is at generator rated voltage.

The Neutral VT ratio must also be entered here for voltage measurement across the neutral grounding device. Note that the neutral VT input is not intended to be used at continuous voltages greater than 240 V. If the voltage across the neutral input is less than 240 V during fault conditions, an auxiliary voltage transformer is not required. If this is not the case, use an auxiliary VT to drop the fault voltage below 240 V. The **NEUTRAL VT RATIO** entered must be the total effective ratio of the grounding transformer and any auxiliary step up or step down VT.

For example, if the distribution transformer ratio is 13200:480 and the auxiliary VT ratio is 600:120, the **NEUTRAL VT RATIO** setpoint is calculated as:

$$\begin{aligned}
 \text{NEUTRAL VT RATIO} &= \text{Distribution Transformer Ratio} \times \text{Auxiliary VT Ratio} : 1 \\
 &= \frac{13200}{480} \times \frac{600}{120} : 1 = 137.50 : 1
 \end{aligned}$$

Therefore, set **NEUTRAL VT RATIO** to 137.50:1

4.3.3 GENERATOR PARAMETERS

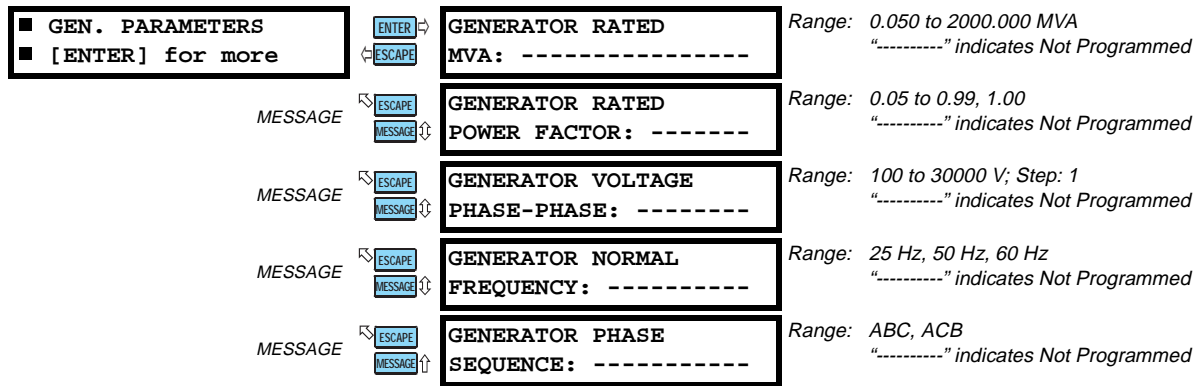

As a safeguard, when a unit is received from the factory, the **PHASE CT PRIMARY** and Generator Parameters setpoints will be defaulted to "-----", indicating they are not programmed. The 489 indicates that it was never programmed. Once these values are entered, the 489 will be in service. All elements associated with power quantities are programmed in per unit values calculated from the rated MVA and power factor. The generator full load amps (FLA) is calculated as

$$\text{Generator FLA} = \frac{\text{Generator Rated MVA}}{\sqrt{3} \times \text{Generator Rated Phase-Phase Voltage}}$$

All voltage protection features that require a level setpoint are programmed in per unit of the rated generator phase-phase voltage. The nominal system frequency must be entered here. This setpoint allows the 489 to determine the internal sampling rate for maximum accuracy. If the sequence of phase rotation for a given system is ACB rather than the standard ABC, the system phase sequence setpoint may be used to accommodate this rotation. This setpoint allows the 489 to properly calculate phase reversal and negative sequence quantities.

4.3.4 SERIAL START/STOP INITIATION

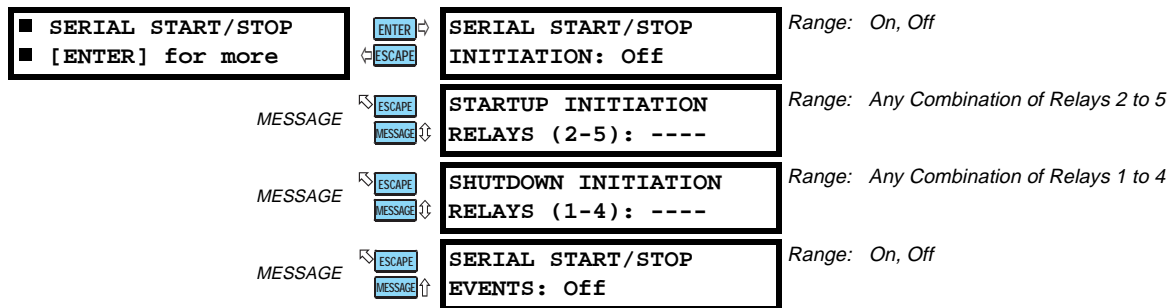

If enabled, this feature will allow the user to initiate a generator startup or shutdown via the RS232/RS485 communication ports. Refer to the Communications chapter for command formats. When a startup command is issued, the auxiliary relay(s) assigned for starting control will be activated for 1 second to initiate startup. When a stop command is issued, the assigned relay(s) will be activated for 1 second to initiate a shutdown.

4.4.1 DESCRIPTION

The 489 has nine digital inputs for use with external contacts. Two of the 489 digital inputs have been pre-assigned as inputs having a specific function. The Access Switch does not have any setpoint messages associated with it. The Breaker Status input, may be configured for either an 'a' or 'b' auxiliary contact. The remaining seven digital inputs are assignable; that is to say, each input may be assigned to any of a number of different functions. Some of those functions are very specific, others may be programmed to adapt to user requirements.

4.4.2 ACCESS SWITCH

Terminals C1 and C2 **must** be shorted to allow changing of any setpoint values from the front panel keypad. This safeguard is in addition to the setpoint passcode feature, which functions independently (see the **S1 489 SETUP / PASSCODE** menu). The access switch has no effect on setpoint programming from the RS232 and RS485 serial communications ports.

4.4.3 BREAKER STATUS

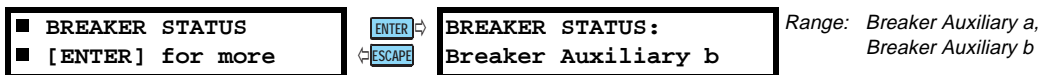

This input is **necessary** for all installations. The 489 determines when the generator is online or offline based on the Breaker Status input. Once 'Breaker Auxiliary a' is chosen, terminals C3 and C4 will be monitored to detect the state of the machine main breaker, open signifying the breaker is open and shorted signifying the breaker is closed. Once "Breaker Auxiliary b" is chosen, terminals C3 and C4 will be monitored to detect the state of the breaker, shorted signifying the breaker is open and open signifying the breaker is closed.

4.4.4 GENERAL INPUT A to G

<ul style="list-style-type: none"> ■ GENERAL INPUT A ■ [ENTER] for more 		[ENTER] → ← [ESCAPE]	ASSIGN DIGITAL INPUT: None	<i>Range: None, Input 1 to Input 7. If an input is assigned to the Tachometer function, it may not be used here</i>
MESSAGE	↻ [ESCAPE]	↻ [MESSAGE]	ASSERTED DIGITAL INPUT STATE: Closed	<i>Range: Closed, Open</i>
MESSAGE	↻ [ESCAPE]	↻ [MESSAGE]	INPUT NAME: Input A	<i>Range: 12 alphanumeric characters</i>
MESSAGE	↻ [ESCAPE]	↻ [MESSAGE]	BLOCK INPUT FROM ONLINE: 0 s	<i>Range: 0 to 5000 step 1. "0" indicates feature is active while generator is offline as well as online.</i>
MESSAGE	↻ [ESCAPE]	↻ [MESSAGE]	GENERAL INPUT A CONTROL: Off	<i>Range: Off, On</i>
MESSAGE	↻ [ESCAPE]	↻ [MESSAGE]	PULSED CONTROL RELAY DWELL TIME: 0.0 s	<i>Range: 0.0 to 25.0 s in steps of 0.1</i>
MESSAGE	↻ [ESCAPE]	↻ [MESSAGE]	ASSIGN CONTROL RELAYS (1-5): -----	<i>Range: Any combination of Relays 1 to 5</i>
MESSAGE	↻ [ESCAPE]	↻ [MESSAGE]	GENERAL INPUT A CONTROL EVENTS: Off	<i>Range: Off, On</i>
MESSAGE	↻ [ESCAPE]	↻ [MESSAGE]	GENERAL INPUT A ALARM: Off	<i>Range: Off, Latched, Unlatched</i>
MESSAGE	↻ [ESCAPE]	↻ [MESSAGE]	ASSIGN ALARM RELAYS (2-5): ---5	<i>Range: Any combination of Relays 2 to 5</i>
MESSAGE	↻ [ESCAPE]	↻ [MESSAGE]	GENERAL INPUT A ALARM DELAY: 0.5 s	<i>Range: 0.1 to 5000.0 s step 0.1</i>
MESSAGE	↻ [ESCAPE]	↻ [MESSAGE]	GENERAL INPUT A ALARM EVENTS: Off	<i>Range: Off, On</i>
MESSAGE	↻ [ESCAPE]	↻ [MESSAGE]	GENERAL INPUT A TRIP: Off	<i>Range: Off, Latched, Unlatched</i>
MESSAGE	↻ [ESCAPE]	↻ [MESSAGE]	ASSIGN TRIP RELAYS (1-4): 1---	<i>Range: Any combination of Relays 1 to 4</i>
MESSAGE	↻ [ESCAPE]	↻ [MESSAGE]	GENERAL INPUT A TRIP DELAY: 5.0 s	<i>Range: 0.1 to 5000.0 in steps of 0.1</i>



The seven General Input functions are flexible enough to meet most of the desired digital input requirements. The asserted state and the name of the digital inputs are programmable. To disable the input functions when the generator is offline, until some time after the generator is brought online, a block time should be set. The input functions will be enabled once the block delay has expired. A value of zero for the block time indicates that the input functions are always enabled.

Inputs may be configured for control, alarm, or trip. If the control feature is enabled, the assigned output relay(s) operate when the input is asserted. If the **PULSED CONTROL RELAY DWELL TIME** is set to 0, the output relay(s) operate only while the input is asserted. However, if a dwell time is assigned, the output relay(s) operate as soon as the input is asserted for a period of time specified by the setpoint. If an alarm or trip is enabled and the input is asserted, an alarm or trip will occur after the specified delay.

4.4.5 REMOTE RESET

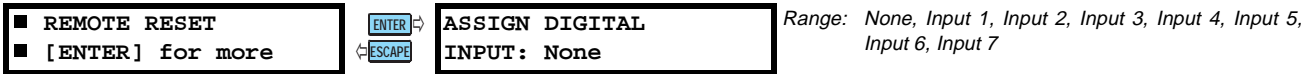

Once an input is assigned to the Remote Reset function, shorting that input will reset any latched trips or alarms that may be active, provided that any thermal lockout time has expired and the condition that caused the alarm or trip is no longer present.

If an input is assigned to the tachometer function, it may not be used here.

4.4.6 TEST INPUT



Once the 489 is in service, it may be tested from time to time as part of a regular maintenance schedule. The unit will have accumulated statistical information relating historically to generator and breaker operation. This information includes: last trip data, peak demand data, MWh and Mvarh metering, parameter averages, RTD maximums, analog input minimums and maximums, number of trips, number of trips by type, number of breaker operations, the number of thermal resets, total generator running hours, and the event record. When the unit is under test and one of the inputs is assigned to the Test Input function, shorting that input will prevent all of this data from being corrupted or updated.

If an input is assigned to the tachometer function, it may not be used here.

4.4.7 THERMAL RESET



During testing or in an emergency, it may be desirable to reset the thermal memory used to zero. If an input is assigned to the Thermal Reset function, shorting that input will reset the thermal memory used to zero. All Thermal Resets will be recorded as events.

If an input is assigned to the tachometer function, it may not be used here.

4.4.8 DUAL SETPOINTS

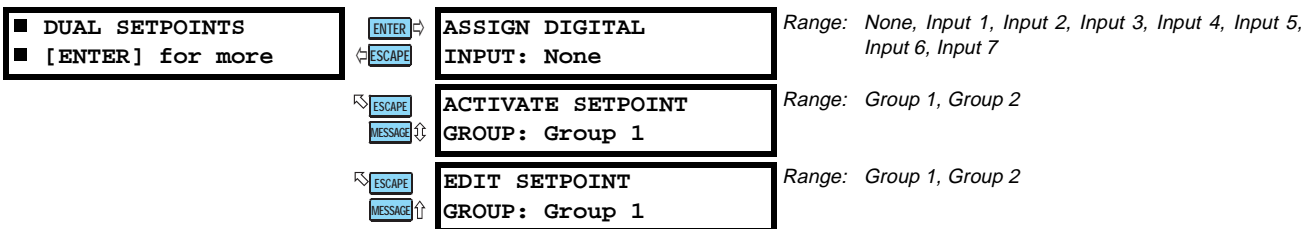

If an input is assigned to the tachometer function, it may not be used here.

This feature allows for dual settings for the current, voltage, power, RTD, and thermal model protection elements (setpoint pages S5 to S9). These settings are organized in two setpoint groups: the main group (Group 1) and the alternate group (Group 2). Only one group of settings are active in the protection scheme at a time.

4

The following chart illustrates the Group 2 (alternate group) setpoints

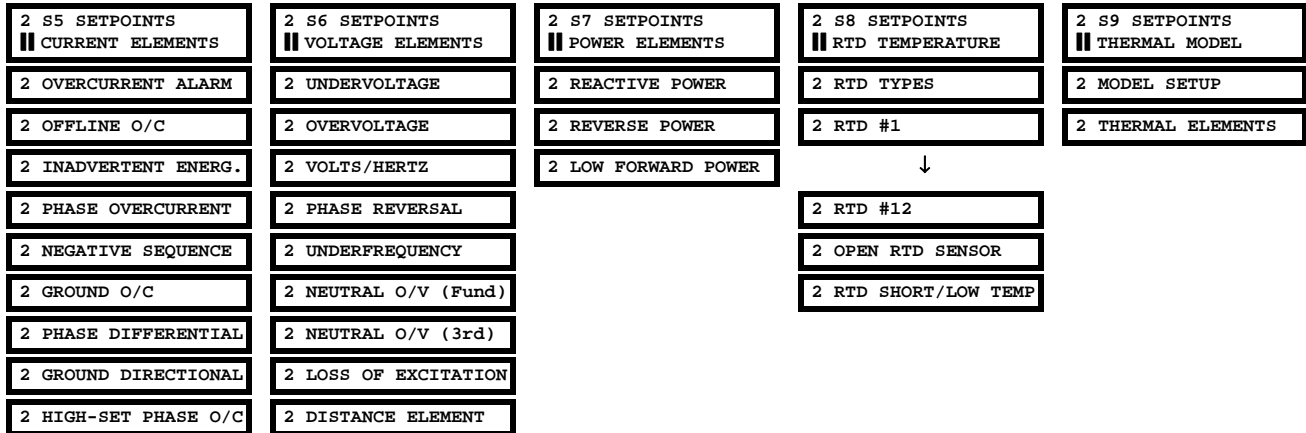

The active group can be selected using the **ACTIVATE SETPOINT GROUP** setpoint or the assigned digital input (shorting that input will activate the alternate set of protection setpoints, Group 2). In the event of a conflict between the **ACTIVATE SETPOINT GROUP** setpoint or the assigned digital input, Group 2 will be activated. The LED indicator on the faceplate of the 489 will indicate when the alternate setpoints are active in the protection scheme. Changing the active setpoint group will be logged as an event. Independently, the setpoints in either group can be viewed and/or edited using the **EDIT SETPOINT GROUP** setpoint. Headers for each setpoint message subgroup that has dual settings will be denoted by a superscript number indicating which setpoint group is being viewed or edited. Also, when a setpoint that has dual settings is stored, the flash message that appears will indicate which setpoint group setting has been changed.



4.4.9 SEQUENTIAL TRIP

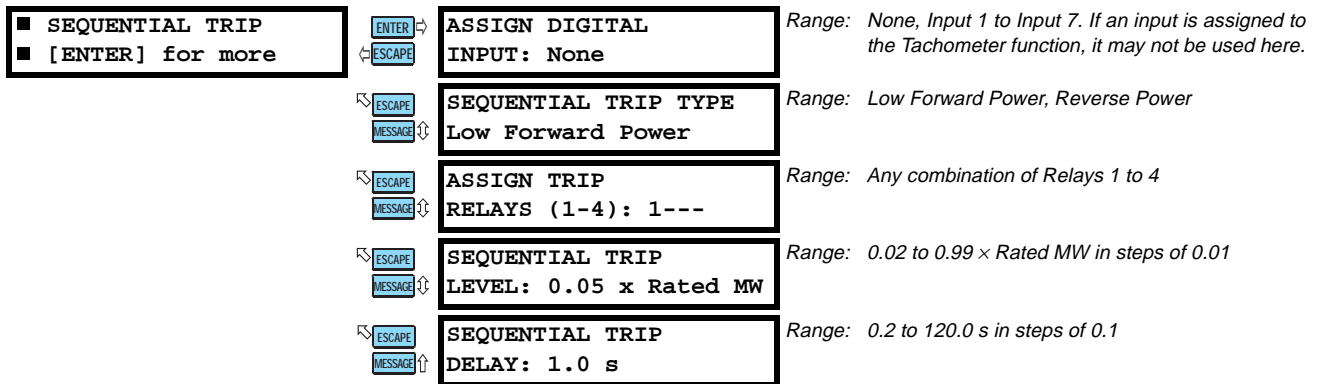





During routine shutdown and for some of the less critical trips, it may be desirable to use the sequential trip function to prevent overspeed. If an input is assigned to the sequential trip function, shorting that input will enable either a low forward power or reverse power function. Once the measured 3-phase total power falls below the low forward power level, or exceeds the reverse power level for the period of time specified, a trip will occur. This time delay will typically be shorter than that used for the standard reverse power or low forward power elements. The level is programmed in per unit of generator rated MW calculated from the rated MVA and rated power factor. If the VT type is selected as None, the sequential trip element will operate as a simple timer. Once the input has been shorted for the period of time specified by the delay, a trip will occur.



The minimum magnitude of power measurement is determined by the phase CT minimum of 2% rated CT primary. If the level for reverse power is set below that level, a trip or alarm will only occur once the phase current exceeds the 2% cutoff.











Users are cautioned that a reverse power element may not provide reliable indication when set to a very low setting, particularly under conditions of large reactive loading on the generator. Under such conditions, low forward power is a more reliable element.

4.4.10 FIELD-BREAKER DISCREPANCY

<ul style="list-style-type: none"> ■ FIELD-BKR DISCREP. ■ [ENTER] for more 	 →	ASSIGN DIGITAL INPUT: None	<i>Range: None, Input 1 to Input 7. If an input is assigned to the Tachometer function, it may not be used here.</i>
	 ↵	FIELD STATUS CONTACT: Auxiliary a	<i>Range: Auxiliary a, Auxiliary b</i>
	 ↵	ASSIGN TRIP RELAYS (1-4): 1---	<i>Range: Any combination of Relays 1 to 4</i>
	 ↵	FIELD-BKR DISCREP. TRIP DELAY: 1.0 s	<i>Range: 0.1 to 500.0 s in steps of 0.1</i>

The field-breaker discrepancy function is intended for use with synchronous generators. If a digital input is assigned to this function, any time the field status contact indicates the field is not applied and the breaker status input indicates that the generator is online, a trip will occur once the time delay has expired. The time delay should be used to prevent possible nuisance tripping during shutdown. The field status contact may be chosen as "Auxiliary a", open signifying the field breaker or contactor is open and shorted signifying the field breaker or contactor is closed. Conversely, the field status contact may be chosen as "Auxiliary b", shorted signifying the field breaker or contactor is open and open signifying it is closed.

4.4.11 TACHOMETER

<ul style="list-style-type: none"> ■ TACHOMETER ■ [ENTER] for more 	 →	ASSIGN DIGITAL INPUT: None	<i>Range: None, Inputs 4 to 7. Only Digital Inputs 4 to 7 may be assigned to the Tachometer</i>
	 ↵	RATED SPEED: 3600 RPM	<i>Range: 100 to 3600 RPM in steps of 1</i>
	 ↵	TACHOMETER ALARM: Off	<i>Range: Off, Latched, Unlatched</i>
	 ↵	ASSIGN ALARM RELAYS (2-5): ---5	<i>Range: Any combination of Relays 2 to 5</i>
	 ↵	TACHOMETER ALARM SPEED: 110% Rated	<i>Range: 101 to 175% in steps of 1</i>
	 ↵	TACHOMETER ALARM DELAY: 1 s	<i>Range: 1 to 250 s in steps of 1</i>
	 ↵	TACHOMETER ALARM EVENTS: Off	<i>Range: On, Off</i>
	 ↵	TACHOMETER TRIP: Off	<i>Range: Off, Latched, Unlatched</i>
	 ↵	ASSIGN TRIP RELAYS (1-4): 1---	<i>Range: Any combination of Relays 1 to 4</i>
	 ↵	TACHOMETER TRIP SPEED: 110% Rated	<i>Range: 101 to 175% in steps of 1</i>
	 ↵	TACHOMETER TRIP DELAY: 1 s	<i>Range: 1 to 250 s in steps of 1</i>

One of assignable digital inputs 4 to 7 may be assigned to the tachometer function to measure mechanical speed. The time between each input closure is measured and converted to an RPM value based on one closure per revolution. If an over-speed trip or alarm is enabled, and the measured RPM exceeds the threshold setpoint for the time specified by the delay, a trip or alarm will occur. The RPM value can be viewed with the **A2 METERING DATA / SPEED / TACHOMETER** actual value.

For example, an inductive proximity probe or hall effect gear tooth sensor may be used to sense the key on the generator. The probe could be powered from the +24V from the digital input power supply. The NPN transistor output could be taken to one of the assignable digital inputs assigned to the tachometer function.

4.4.12 WAVEFORM CAPTURE

■ WAVEFORM CAPTURE
 ■ [ENTER] for more



ASSIGN DIGITAL
 INPUT: None

Range: None, Input 1 to Input 7. If an input is assigned to the Tachometer function, it may not be used here.

This feature may be used to trigger the waveform capture from an external contact. When one of the inputs is assigned to the Waveform Capture function, shorting that input will trigger the waveform.

4.4.13 GROUND SWITCH STATUS

■ GND SWITCH STATUS
 ■ [ENTER] for more



ASSIGN DIGITAL
 INPUT: None

Range: None, Input 1 to Input 7. If an input is assigned to the Tachometer function, it may not be used here.



GROUND SWITCH
 CONTACT: Auxiliary a

Range: Auxiliary a, Auxiliary b

This function is used to detect the status of a grounding switch for the generator for which the relay is installed. Refer to Appendix B for Application Notes.

4.5.1 DESCRIPTION

Five of the six output relays are always non-failsafe, R6 Service is always failsafe. As failsafe, R6 relay will be energized normally and de-energize when called upon to operate. It will also de-energize when control power to the 489 is lost and therefore, be in its operated state. All other relays, being non-failsafe, will be de-energized normally and energize when called upon to operate. Obviously, when control power is lost to the 489, the output relays must be de-energized and therefore, they will be in their non-operated state. Shorting bars in the drawout case ensure that when the 489 is drawn out, no trip or alarm occurs. The R6 Service output will however indicate that the 489 has been drawn out.

4.5.2 RELAY RESET MODE

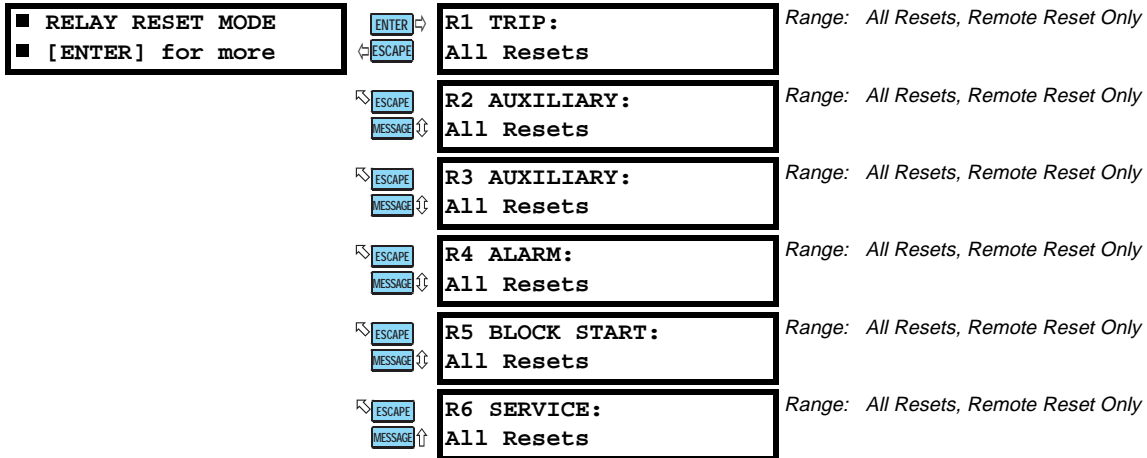

Unlatched trips and alarms will reset automatically once the condition is no longer present. Latched trip and alarm features may be reset at any time, providing that the condition that caused the trip or alarm is no longer present and any lockout time has expired. If any condition may be reset, the Reset Possible LED will be lit. The relays may be programmed to All Resets which allows reset from the front keypad or the remote reset digital input or the communications port. Optionally, they may be programmed to reset by the Remote Reset Only (by the remote reset digital input or the communications port).

For example, selected trips such as Instantaneous Overcurrent and Ground Fault may be assigned to R2 so that they may only be reset via. the Remote Reset digital input or the Communication Port. The Remote Reset terminals would be connected to a keyswitch so that only authorized personnel could reset such a critical trip.

- Assign only Short Circuit and Ground Fault to R2
- Program R2 to Remote Reset Only

4.6.1 INVERSE TIME OVERCURRENT CURVE CHARACTERISTICS

The 489 inverse time overcurrent curves may be either ANSI, IEC, or GE Type IAC standard curve shapes. This allows for simplified coordination with downstream devices. If however, none of these curve shapes is adequate, the FlexCurve™ may be used to customize the inverse time curve characteristics. Definite time is also an option that may be appropriate if only simple protection is required.

Table 4–1: 489 OVERCURRENT CURVE TYPES

ANSI	IEC	GE TYPE IAC	OTHER
ANSI Extremely Inverse	IEC Curve A (BS142)	IAC Extremely Inverse	FlexCurve™
ANSI Very Inverse	IEC Curve B (BS142)	IAC Very Inverse	Definite Time
ANSI Normally Inverse	IEC Curve C (BS142)	IAC Inverse	
ANSI Moderately Inverse	IEC Short Inverse	IAC Short Inverse	

A multiplier setpoint allows selection of a multiple of the base curve shape that is selected with the curve shape setpoint. Unlike the electromechanical time dial equivalent, trip times are directly proportional to the time multiplier setting value. For example, all trip times for a multiplier of 10 are 10 times the multiplier 1 or base curve values. Setting the multiplier to zero results in an instantaneous response to all current levels above pickup.



Regardless of the trip time that results from the curve multiplier setpoint, the 489 cannot trip any quicker than one to two cycles plus the operate time of the output relay.

NOTE

Time overcurrent tripping time calculations are made with an internal “energy capacity” memory variable. When this variable indicates that the energy capacity has reached 100%, a time overcurrent trip is generated. If less than 100% is accumulated in this variable and the current falls below the dropout threshold of 97 to 98% of the pickup value, the variable must be reduced. Two methods of this resetting operation are available, “Instantaneous” and “Linear”. The Instantaneous selection is intended for applications with other relays, such as most static units, which set the energy capacity directly to zero when the current falls below the reset threshold. The Linear selection can be used where the 489 must coordinate with electromechanical units. With this setting, the energy capacity variable is decremented according to the following equation.

$$T_{RESET} = E \times M \times C_R$$

where: T_{RESET} = reset time in seconds

E = energy capacity reached (per unit)

M = curve multiplier

C_R = characteristic constant (5 for ANSI, IAC, Definite Time and FlexCurves™, 80 for IEC curves)

a) ANSI CURVES

The ANSI time overcurrent curve shapes conform to industry standard curves and fit into the ANSI C37.90 curve classifications for extremely, very, normally, and moderately inverse. The 489 ANSI curves are derived from the formula:

$$T = M \times \left(A + \frac{B}{(I/I_{pickup}) - C} + \frac{D}{((I/I_{pickup}) - C)^2} + \frac{E}{((I/I_{pickup}) - C)^3} \right)$$

where: T = Trip Time in seconds

M = Multiplier Setpoint

I = Input Current

I_{pickup} = Pickup Current Setpoint

A, B, C, D, E = Constants

Table 4–2: ANSI INVERSE TIME CURVE CONSTANTS

ANSI CURVE SHAPE	CONSTANTS				
	A	B	C	D	E
EXTREMELY INVERSE	0.0399	0.2294	0.5000	3.0094	0.7222
VERY INVERSE	0.0615	0.7989	0.3400	–0.2840	4.0505
NORMALLY INVERSE	0.0274	2.2614	0.3000	–4.1899	9.1272
MODERATELY INVERSE	0.1735	0.6791	0.8000	–0.0800	0.1271

b) IEC CURVES

For European applications, the relay offers the four standard curves defined in IEC 255-4 and British standard BS142. These are defined as IEC Curve A, IEC Curve B, IEC Curve C, and Short Inverse. The formula for these curves is:

$$T = M \times \left(\frac{K}{(I/I_{pickup})^E - 1} \right)$$

where: T = Trip Time in seconds
 M = Multiplier Setpoint
 I = Input Current
 I_{pickup} = Pickup Current Setpoint
 K, E = Constants

Table 4-3: IEC (BS) INVERSE TIME CURVE CONSTANTS

IEC (BS) CURVE SHAPE	CONSTANTS	
	K	E
IEC CURVE A (BS142)	0.140	0.020
IEC CURVE B (BS142)	13.500	1.000
IEC CURVE C (BS142)	80.000	2.000
SHORT INVERSE	0.050	0.040

c) IAC CURVES

The curves for the General Electric type IAC relay family are derived from the formula:

$$T = M \times \left(A + \frac{B}{(I/I_{pickup}) - C} + \frac{D}{((I/I_{pickup}) - C)^2} + \frac{E}{((I/I_{pickup}) - C)^3} \right)$$

where: T = Trip Time in seconds
 M = Multiplier Setpoint
 I = Input Current
 I_{pickup} = Pickup Current Setpoint
 A, B, C, D, E = Constants

Table 4-4: IAC INVERSE TIME CURVE CONSTANTS

IAC CURVE SHAPE	CONSTANTS				
	A	B	C	D	E
IAC EXTREME INVERSE	0.0040	0.6379	0.6200	1.7872	0.2461
IAC VERY INVERSE	0.0900	0.7955	0.1000	-1.2885	7.9586
IAC INVERSE	0.2078	0.8630	0.8000	-0.4180	0.1947
IAC SHORT INVERSE	0.0428	0.0609	0.6200	-0.0010	0.0221

d) FLEXCURVE™

The custom FlexCurve™ has setpoints for entering times to trip at the following current levels: 1.03, 1.05, 1.1 to 6.0 in steps of 0.1 and 6.5 to 20.0 in steps of 0.5. The relay then converts these points to a continuous curve by linear interpolation between data points. To enter a custom FlexCurve™, read off each individual point from a time overcurrent coordination drawing and enter it into a table as shown. Then transfer each individual point to the 489 using either the 489PC software or the front panel keys and display.

Table 4–5: FLEXCURVE™ TABLE

PICKUP (I / I_{pickup})	TRIP TIME (MS)	PICKUP (I / I_{pickup})	TRIP TIME (MS)	PICKUP (I / I_{pickup})	TRIP TIME (MS)	PICKUP (I / I_{pickup})	TRIP TIME (MS)
1.03		2.9		4.9		10.5	
1.05		3.0		5.0		11.0	
1.1		3.1		5.1		11.5	
1.2		3.2		5.2		12.0	
1.3		3.3		5.3		12.5	
1.4		3.4		5.4		13.0	
1.5		3.5		5.5		13.5	
1.6		3.6		5.6		14.0	
1.7		3.7		5.7		14.5	
1.8		3.8		5.8		15.0	
1.9		3.9		5.9		15.5	
2.0		4.0		6.0		16.0	
2.1		4.1		6.5		16.5	
2.2		4.2		7.0		17.0	
2.3		4.3		7.5		17.5	
2.4		4.4		8.0		18.0	
2.5		4.5		8.5		18.5	
2.6		4.6		9.0		19.0	
2.7		4.7		9.5		19.5	
2.8		4.8		10.0		20.0	

e) DEFINITE TIME CURVE

The definite time curve shape causes a trip as soon as the pickup level is exceeded for a specified period of time. The base definite time curve delay is 100 ms. The curve multiplier of 0.00 to 1000.00 makes this delay adjustable from instantaneous to 100.00 seconds in steps of 1 ms.

$$T = M \times 100 \text{ ms, when } I > I_{pickup}$$

where: T = Trip Time in seconds

M = Multiplier Setpoint

I = Input Current

I_{pickup} = Pickup Current Setpoint

4.6.2 OVERCURRENT ALARM

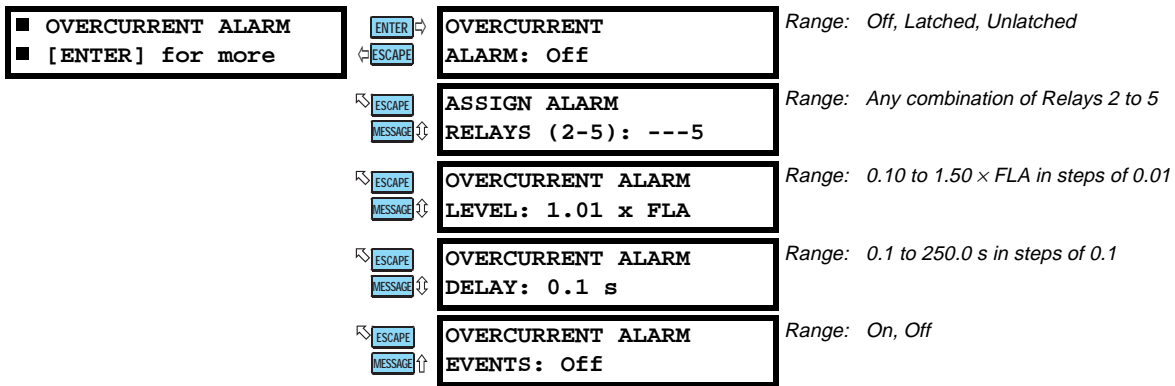

If enabled as Latched or Unlatched, the Overcurrent Alarm will function as follows: If the average generator current (RMS) measured at the output CTs exceeds the level programmed for the period of time specified, an alarm will occur. If programmed as unlatched, the alarm will reset itself when the overcurrent condition is no longer present. If programmed as latched, once the overcurrent condition is gone, the reset key must be pressed to reset the alarm. The generator FLA is calculated as:

$$\text{Generator FLA} = \sqrt{3} \times \text{rated generator phase-phase voltage}$$

4.6.3 OFFLINE OVERCURRENT

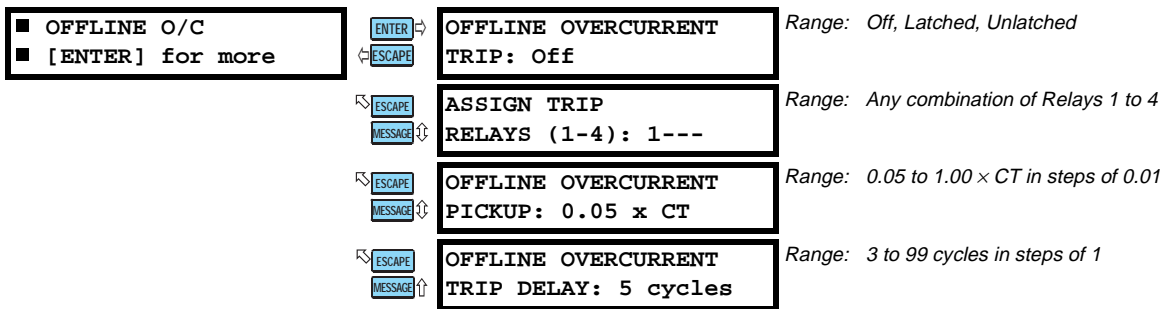

When a synchronous generator is offline, there should be no measurable current flow in any of the three phases unless the unit is supplying its own station load. Also, since the generator is not yet online, differentiation between system faults and machine faults is easier. The offline overcurrent feature is active only when the generator is offline and uses the neutral end CT measurements (Ia, Ib, Ic). It may be set much more sensitive than the differential element to detect high impedance phase faults. Since the breaker auxiliary contacts wired to the 489 Breaker Status input may not operate at exactly the same time as the main breaker contacts, the time delay should be coordinated with the difference of the operation times. In the event of a low impedance fault, the differential element will still shutdown the generator quickly.



If the unit auxiliary transformer is on the generator side of the breaker, the pickup level must be set greater than the unit auxiliary load.

4.6.4 INADVERTENT ENERGIZATION

<ul style="list-style-type: none"> ■ INADVERTENT ENERG. ■ [ENTER] for more 	ENTER →	INADVERTENT ENERGIZE	Range: Off, Latched, Unlatched
	← ESCAPE	TRIP: Off	
	↻ ESCAPE	ASSIGN ALARM	Range: Any combination of Relays 1 to 4
	MESSAGE ↕	RELAYS (1-4): 1---	
	↻ ESCAPE	ARMING SIGNAL:	Range: U/V and Offline, U/V or Offline
MESSAGE ↕	U/V and Offline		
↻ ESCAPE	MESSAGE ↕	INADVERTENT ENERGIZE	Range: 0.05 to 3.00 × CT in steps of 0.01
MESSAGE ↕	O/C PICKUP: 0.05 × CT		
↻ ESCAPE	MESSAGE ↕	INADVERTENT ENERGIZE	Range: 0.50 to 0.99 × Rated Voltage in steps of 0.01
MESSAGE ↕	PICKUP: 0.50 × Rated V		

The logic diagram for the inadvertent energization protection feature is shown below. The feature may be armed when all of the phase voltages fall below the undervoltage pickup level *and* the unit is offline. This would be the case when the VTs are on the generator side of the disconnect device. If however, the VTs are on the power system side of the disconnect device, the feature should be armed if all of the phase voltages fall below the undervoltage pickup level *or* the unit is offline. When the feature is armed, if any one of the phase currents measured at the output CTs exceeds the overcurrent level programmed, a trip will occur.

 5 seconds to arm, 250 ms to disarm.
NOTE

Protection can be provided for poor synchronization by using the "U/V or Offline" arming signal. During normal synchronization, there should be relatively low current measured. If however, synchronization is attempted when conditions are not appropriate, a large current that is measured within 250 ms after the generator is placed online would result in a trip.

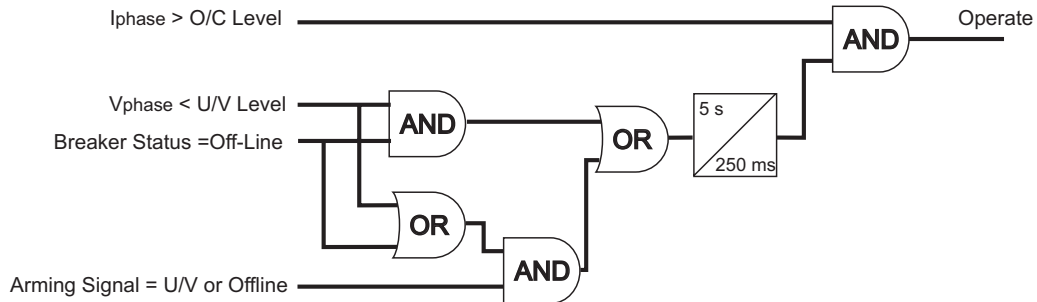

Figure 4–1: INADVERTENT ENERGIZATION

4.6.5 VOLTAGE RESTRAINED PHASE OVERCURRENT

■ PHASE OVERCURRENT ■ [ENTER] for more	ENTER →	PHASE OVERCURRENT	Range: Off, Latched, Unlatched
	← ESCAPE	TRIP: Off	
	ESCAPE	ASSIGN TRIP	Range: Any combination of Relays 1 to 4
	MESSAGE ↕	RELAYS (1-4): 1---	
	ESCAPE	ENABLE VOLTAGE	Range: No, Yes
	MESSAGE ↕	RESTRAINT: No	
	ESCAPE	VOLTAGE LOWER	Range: 10 to 60%. Seen only if ENABLE VOLTAGE RESTRAINT is "Yes"
	MESSAGE ↕	LIMIT: 10%	
	ESCAPE	PHASE OVERCURRENT	Range: 0.15 to 20.00 × CT in steps of 0.01
	MESSAGE ↕	PICKUP: 10.00 × CT	
ESCAPE	CURVE SHAPE:	Range: See Table 4-1: 489 OVERCURRENT CURVE TYPES on page 4-17.	
MESSAGE ↕	ANSI Extremely Inv.		
ESCAPE	FLEXCURVE TRIP TIME	Range: 0 to 65535 ms	
MESSAGE ↕	AT 1.03 × PU: 65535 ms	Seen only if CURVE SHAPE is set to "Flexcurve"	
	↓		
ESCAPE	FLEXCURVE TRIP TIME	Range: 0 to 65535 ms	
MESSAGE ↕	AT 20.0 × PU: 65535 ms	Seen only if CURVE SHAPE is set to "Flexcurve"	
ESCAPE	OVERCURRENT CURVE	Range: 0.00 to 1000.00 in steps of 0.01	
MESSAGE ↕	MULTIPLIER: 1.00		
ESCAPE	OVERCURRENT CURVE	Range: Instantaneous, Linear	
MESSAGE ↕	RESET: Instantaneous		

If the primary system protection fails to properly isolate phase faults, the voltage restrained overcurrent acts as system backup protection. The magnitude of each phase current measured at the output CTs is used to time out against an inverse time curve. The 489 inverse time curve for this element may be either ANSI, IEC, or GE Type IAC standard curve shapes. This allows for simplified coordination with downstream devices. If these curve shapes are not adequate, FlexCurves™ may be used to customize the inverse time curve characteristics.

The voltage restraint feature lowers the pickup value of each phase time overcurrent element in a fixed relationship (see figure below) with the corresponding input voltage to a minimum pickup of $0.15 \times CT$. The **VOLTAGE LOWER LIMIT** setpoint prevents very rapid tripping prior to primary protection clearing a fault when voltage restraint is enabled and severe close-in fault has occurred. If voltage restraint is not required, select "No" for this setpoint. If the VT type is selected as "None" or a VT fuse loss is detected, the voltage restraint is ignored and the element operates as simple phase overcurrent.



A fuse failure is detected within 99 ms; therefore, any voltage restrained overcurrent trip should have a time delay of 100 ms or more or nuisance tripping on fuse loss could occur.

NOTE

For example, to determine the voltage restrained phase overcurrent pickup level under the following situation:

- Phase Overcurrent Pickup = $2.00 \times CT$
- **ENABLE VOLTAGE RESTRAINT** = Yes
- Phase-Phase Voltage / Rated Phase-Phase Voltage = 0.4 p.u. V

The voltage restrained phase overcurrent pickup level is calculated as follows:

$$\begin{aligned} \text{Voltage Restrained Phase OC Pickup} &= \text{Phase OC Pickup} \times \text{Voltage Restrained Pickup Curve Multiplier} \times CT \\ &= (2 \times 0.4) \times CT \end{aligned}$$

The 489 phase overcurrent restraint voltages and restraint characteristic are shown below:

PHASE OVERCURRENT RESTRAINT VOLTAGES:

CURRENT	VOLTAGE
IA	Vab
IB	Vbc
IC	Vca

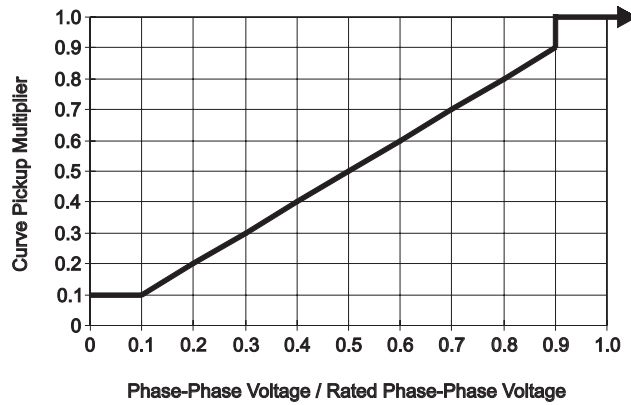

Figure 4-2: VOLTAGE RESTRAINT CHARACTERISTIC

4.6.6 NEGATIVE SEQUENCE OVERCURRENT

<ul style="list-style-type: none"> ■ NEGATIVE SEQUENCE ■ [ENTER] for more 	[ENTER]	NEGATIVE SEQUENCE	Range: Off, Latched, Unlatched
	[ESCAPE]	ALARM: Off	
	[ESCAPE]	ASSIGN ALARM	Range: Any combination of Relays 2 to 5
	[MESSAGE]	RELAYS (2-5): ---5	
	[ESCAPE]	NEG. SEQUENCE ALARM	Range: 3 to 100% FLA in steps of 1
	[MESSAGE]	PICKUP: 3% FLA	
	[ESCAPE]	NEGATIVE SEQUENCE	Range: 0.1 to 100.0 s in steps of 0.1
	[MESSAGE]	ALARM DELAY: 0.5 s	
	[ESCAPE]	NEGATIVE SEQUENCE	Range: On, Off
	[MESSAGE]	ALARM EVENTS: Off	
	[ESCAPE]	NEGATIVE SEQUENCE	Range: Off, Latched, Unlatched
	[MESSAGE]	O/C TRIP: Off	
[ESCAPE]	ASSIGN TRIP	Range: Any combination of Relays 1 to 4	
[MESSAGE]	RELAYS (1-4): 1---		
[ESCAPE]	NEG. SEQUENCE O/C	Range: 3 to 100% FLA in steps of 1	
[MESSAGE]	TRIP PICKUP: 8% FLA		
[ESCAPE]	NEG. SEQUENCE O/C	Range: 1 to 100 in steps of 1	
[MESSAGE]	CONSTANT K: 1		
[ESCAPE]	NEG. SEQUENCE O/C	Range: 10 to 1000 s in steps of 1	
[MESSAGE]	MAX. TIME: 1000 s		
[ESCAPE]	NEG. SEQUENCE O/C	Range: 0.0 to 999.9 s in steps of 0.01	
[MESSAGE]	RESET RATE: 227.0 s		

Rotor heating in generators due to negative sequence current is a well known phenomenon. Generators have very specific capability limits where unbalanced current is concerned (see ANSI C50.13). A generator should have a rating for both continuous and also short time operation when negative sequence current components are present.

$$K = I_2^2 T$$

defines the short time negative sequence capability of the generator

where: K = constant from generator manufacturer depending on generator size and design
 I_2 = negative sequence current as a percentage of generator rated FLA as measured at the output CTs
 t = time in seconds when $I_2 >$ pickup (minimum 250 ms, maximum defined by setpoint)

The 489 has a definite time alarm and inverse time overcurrent curve trip to protect the generator rotor from overheating due to the presence of negative sequence currents. Pickup values are negative sequence current as a percent of generator rated full load current. The generator FLA is calculated as:

$$\text{Generator FLA} = \frac{\text{Generator Rated MVA}}{\sqrt{3} \times \text{Rated Generator Phase-Phase Voltage}}$$

Negative sequence overcurrent maximum time defines the maximum time that any value of negative sequence current in excess of the pickup value will be allowed to persist before a trip is issued. The reset rate provides a thermal memory of previous unbalance conditions. It is the linear reset time from the threshold of trip.



Unusually high negative sequence current levels may be caused by incorrect phase CT wiring.

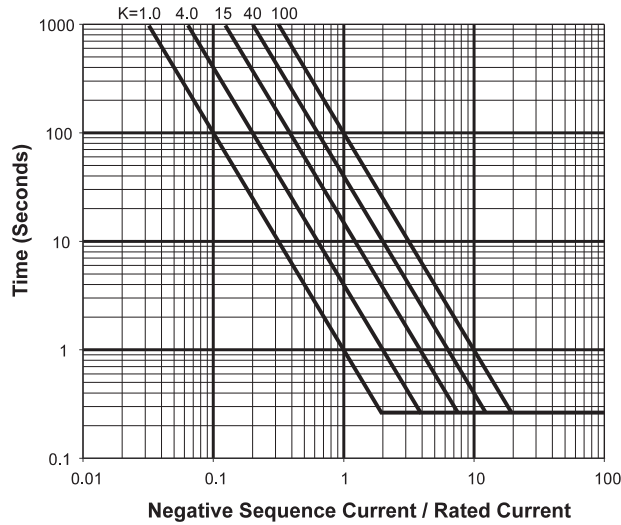

Figure 4-3: NEGATIVE SEQUENCE INVERSE TIME CURVES

4.6.7 GROUND OVERCURRENT

<ul style="list-style-type: none"> ■ GROUND O/C ■ [ENTER] for more 	ENTER	GROUND OVERCURRENT ALARM: Off	Range: Off, Latched, Unlatched
	ESCAPE	ASSIGN ALARM RELAYS (2-5): ---5	Range: Any combination of Relays 2 to 5
	ESCAPE	GROUND O/C ALARM PICKUP: 0.20 x CT	Range: 0.05 to 20.00 x CT in steps of 0.01
	ESCAPE	GROUND O/C ALARM DELAY: 0 cycles	Range: 0 to 100 cycles step 1
	ESCAPE	GROUND OVERCURRENT ALARM EVENTS: Off	Range: On, Off
	ESCAPE	GROUND OVERCURRENT TRIP: Off	Range: Off, Latched, Unlatched
	ESCAPE	ASSIGN TRIP RELAYS (1-4): 1---	Range: Any combination of Relays 1 to 4
	ESCAPE	GROUND O/C TRIP PICKUP: 0.20 x CT	Range: 0.05 to 20.00 x CT in steps of 0.01
	ESCAPE	CURVE SHAPE: ANSI Extremely Inv.	Range: see Table 4-1: 489 OVERCURRENT CURVE TYPES on page 4-17.
	ESCAPE	FLEXCURVE TRIP TIME AT 1.03 x PU: 65535 ms	Range: 0 to 65535 ms Seen only if CURVE SHAPE is Flexcurve
	ESCAPE	FLEXCURVE TRIP TIME AT 1.05 x PU: 65535 ms	Range: 0 to 65535 ms Seen only if CURVE SHAPE is Flexcurve
	ESCAPE	FLEXCURVE TRIP TIME AT 20.0 x PU: 65535 ms	Range: 0 to 65535 ms Seen only if CURVE SHAPE is set to Flexcurve
	ESCAPE	OVERCURRENT CURVE MULTIPLIER: 1.00	Range: 0.00 to 1000.00 in steps of 0.01
	ESCAPE	OVERCURRENT CURVE RESET: Instantaneous	Range: Instantaneous, Linear



The 489 ground overcurrent feature consists of both an alarm and a trip element. The magnitude of measured ground current is used to time out against the definite time alarm or inverse time curve trip. The 489 inverse time curve for this element may be either ANSI, IEC, or GE Type IAC standard curve shapes. This allows for simplified coordination with downstream devices. If however, none of these curves shapes is adequate, the FlexCurve™ may be used to customize the inverse time curve characteristics. If the Ground CT is selected as "None", the ground overcurrent protection is disabled.



The pickup level for the ground current elements is programmable as a multiple of the CT. The 50:0.025 CT is intended for very sensitive detection of ground faults and its nominal CT rating for the 489 is 50:0.025.

For example, if the ground CT is 50:0.025, a pickup of 0.20 would be $0.20 \times 5 = 1$ A primary. If the ground CT is 50:0.025, a pickup of 0.05 would be $0.05 \times 5 = 0.25$ A primary.

4.6.8 PHASE DIFFERENTIAL

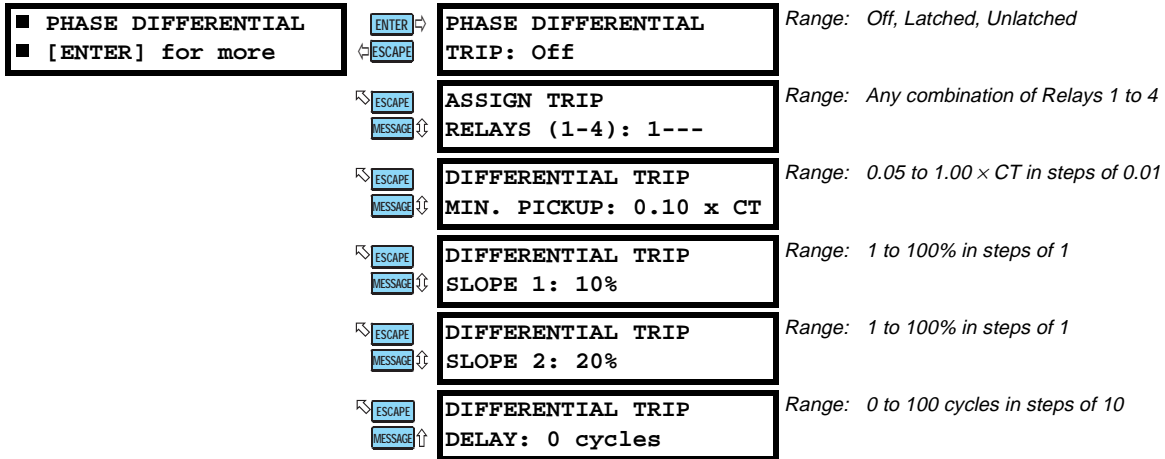

4

The 489 percentage differential element has a dual slope characteristic. This allows for very sensitive settings when fault current is low and less sensitive settings when fault current is high (more than $2 \times CT$) and CT performance may produce erroneous operate signals. The **DIFFERENTIAL TRIP MIN PICKUP** value sets an absolute minimum pickup in terms of operate current. The delay can be fine-tuned to an application so it still responds very fast, but rides through normal operational disturbances.

The differential element for phase A will operate when $I_{operate} > k \times I_{restraint}$

where: $I_{operate} = \bar{I}_A - \bar{I}_a =$ operate current

$$I_{restraint} = \frac{|I_A| + |I_a|}{2} = \text{restraint current}$$

k = characteristic slope of the differential element in percent
 slope = 1 if $I_R < 2 \times CT$; slope = 2 if $I_R \geq 2 \times CT$

I_A = phase current measured at the output CT

I_a = phase current measured at the neutral end CT

Differential elements for phase B and phase C operate in the same manner.

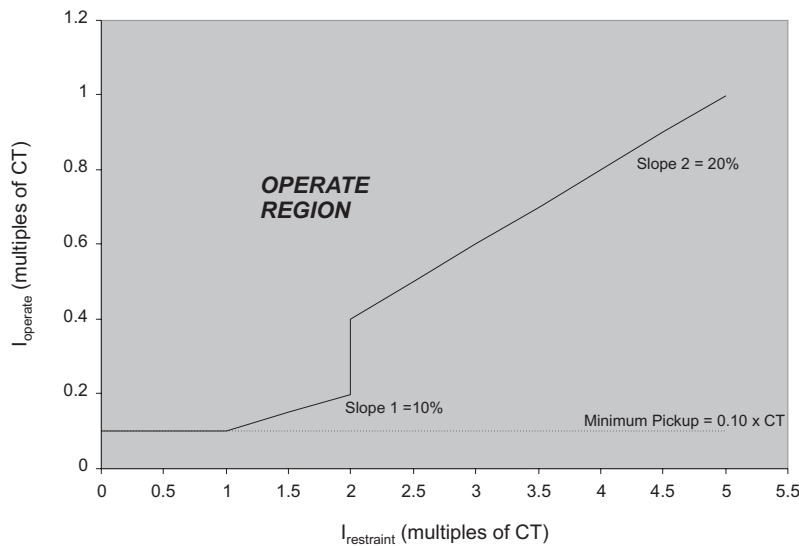

Figure 4-4: DIFFERENTIAL ELEMENTS

4.6.9 GROUND DIRECTIONAL

<ul style="list-style-type: none"> ■ GROUND DIRECTIONAL ■ [ENTER] for more 	ENTER →	SUPERVISE WITH DIGITAL INPUTS: Yes	Range: Yes, No. Seen only if a digital input is assigned to Ground Switch Status
	← ESCAPE		
	↻ ESCAPE	GROUND DIRECTIONAL MTA: 0°	Range: 0°, 90°, 180°, 270° Note: MTA = Maximum Torque Angle
	MESSAGE ⇅		
	↻ ESCAPE	GROUND DIRECTIONAL ALARM: Off	Range: Off, Latched, Unlatched
	MESSAGE ⇅		
	↻ ESCAPE	ASSIGN ALARM RELAYS (2-5): ---5	Range: Any combination of Relays 2 to 5
	MESSAGE ⇅		
	↻ ESCAPE	GROUND DIR. ALARM PICKUP: 0.05 x CT	Range: 0.05 to 20.00 x CT in steps of 0.01
	MESSAGE ⇅		
	↻ ESCAPE	GROUND DIR. ALARM DELAY: 3.0 sec.	Range: 0.1 to 120.0 sec. in steps of 0.1
MESSAGE ⇅			
↻ ESCAPE	GROUND DIR. ALARM EVENTS: Off	Range: On, Off	
MESSAGE ⇅			
↻ ESCAPE	GROUND DIRECTIONAL TRIP: Off	Range: Off, Latched, Unlatched	
MESSAGE ⇅			
↻ ESCAPE	ASSIGN TRIP RELAYS (1-4): 1---	Range: Any combination of Relays 1 to 4	
MESSAGE ⇅			
↻ ESCAPE	GROUND DIR. TRIP PICKUP: 0.05 x CT	Range: 0.05 to 20.00 x CT in steps of 0.01	
MESSAGE ⇅			
↻ ESCAPE	GROUND DIR. TRIP DELAY: 3.0 sec.	Range: 0.1 to 120.0 sec. in steps of 0.1	
MESSAGE ⇅			



The 489 detects ground directional by using two measurement quantities: V_0 and I_0 . The angle between these quantities determines if a ground fault is within the generator or not. This function should be coordinated with the 59GN element (95% stator ground protection) to ensure proper operation of the element. Particularly, this element should be faster. This element must use a core balance CT to derive the I_0 signal. Polarity is critical in this element. The protection element is blocked for neutral voltages, V_0 , below 2.0 V secondary. Refer to the APPLICATION NOTES for more details.



The pickup level for the ground current elements is programmable as a multiple of the CT. The 50:0.025 CT is intended for very sensitive detection of ground faults and its nominal CT rating for the 489 is 50:0.025.

For example, if the ground CT is 50:0.025, a pickup of 0.20 would be $0.20 \times 5 = 1$ A primary. If the ground CT is 50:0.025, a pickup of 0.05 would be $0.05 \times 5 = 0.25$ A primary. Refer to Appendix B for Application Notes.

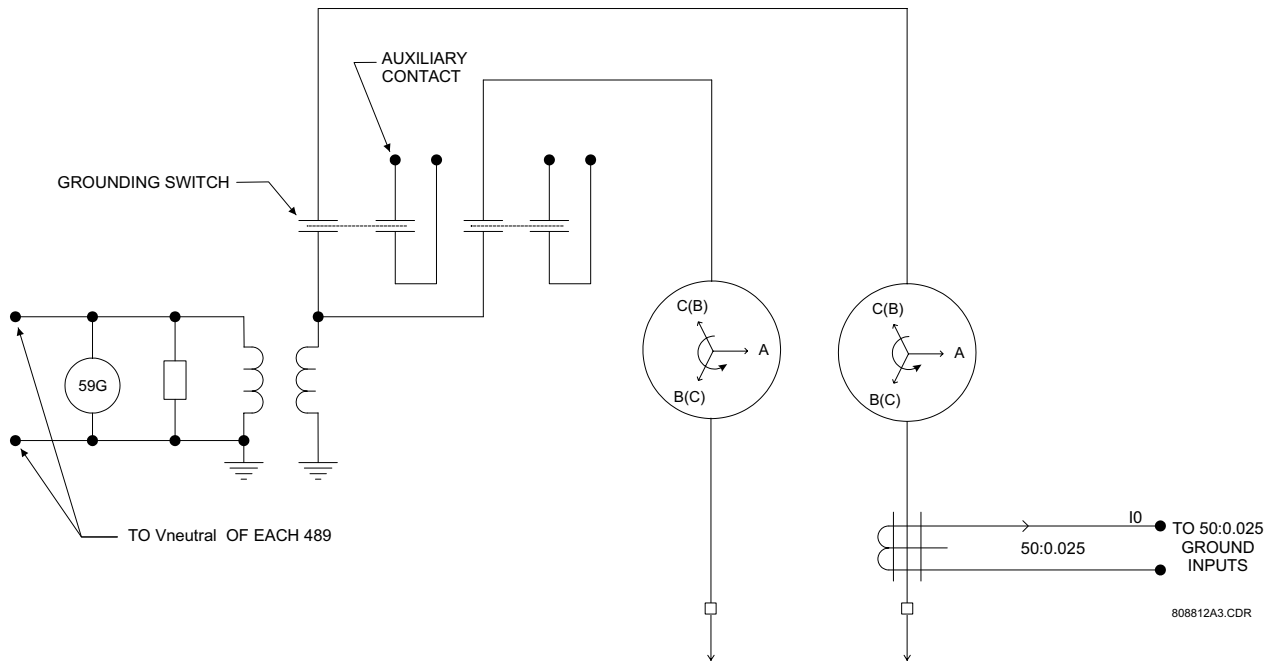

Figure 4-5: GROUND DIRECTIONAL DETECTION

4.6.10 HIGH-SET PHASE OVERCURRENT

<ul style="list-style-type: none"> ■ HIGH-SET PHASE O/C ■ [ENTER] for more 	[ENTER]	HIGH-SET PHASE O/C	Range: Off, Latched, Unlatched
	[ESCAPE]	TRIP: Off	
	[ESCAPE]	ASSIGN TRIP	Range: Any combination of Relays 1 to 4
	[MESSAGE]	RELAYS (1-4): 1---	
	[ESCAPE]	HIGH-SET PHASE O/C	Range: 0.15 to 20.00 x CT in steps of 0.01
	[MESSAGE]	PICKUP: 5.00 x CT	
	[ESCAPE]	HIGH-SET PHASE O/C	Range: 0.00 to 100.00 s in steps of 0.01
	[MESSAGE]	DELAY: 1.00 s	

If any individual phase current exceeds the pickup level for the specified trip time a trip will occur if the feature is enabled. The element operates in both online and offline conditions. This element can be used as a backup feature to other protection elements. In situations where generators are connected in parallel this element would be set above the maximum current contribution from the generator on which the protection is installed. With this setting, the element would provide proper selective tripping. The basic operating time of the element with no time delay is 50 ms at 50/60 Hz.

4.7.1 UNDERVOLTAGE

<ul style="list-style-type: none"> ■ UNDERVOLTAGE ■ [ENTER] for more 	ENTER	UNDERVOLTAGE	Range: Off, Latched, Unlatched
	ESCAPE	ALARM: Off	
	ESCAPE	ASSIGN ALARM	Range: Any combination of Relays 2 to 5
	MESSAGE	RELAYS (2-5): ---5	
	ESCAPE	UNDERVOLTAGE ALARM	Range: 0.50 to 0.99 x Rated in steps of 0.01
	MESSAGE	PICKUP: 0.85 x Rated	
	ESCAPE	UNDERVOLTAGE ALARM	Range: 0.2 to 120.0 s in steps of 0.1
	MESSAGE	DELAY: 3.0 s	
	ESCAPE	UNDERVOLTAGE ALARM	Range: On, Off
	MESSAGE	EVENTS: Off	
	ESCAPE	UNDERVOLTAGE	Range: Off, Latched, Unlatched
	MESSAGE	TRIP: Off	
	ESCAPE	ASSIGN TRIP	Range: Any combination of Relays 1 to 4
	MESSAGE	RELAYS (1-4): 1---	
ESCAPE	UNDERVOLTAGE TRIP	Range: 0.50 to 0.99 x Rated in steps of 0.01	
MESSAGE	PICKUP: 0.80 x Rated		
ESCAPE	UNDERVOLTAGE TRIP	Range: 0.2 to 10.0 s in steps of 0.1	
MESSAGE	DELAY: 1.0 s		
ESCAPE	UNDERVOLTAGE CURVE	Range: 0.0 to 999.9 s in steps of 0.1	
MESSAGE	RESET RATE: 1.4 s		
ESCAPE	UNDERVOLTAGE TRIP	Range: Curve, Definite Time	
MESSAGE	ELEMENT: Curve		



The undervoltage elements may be used for protection of the generator and/or its auxiliary equipment during prolonged undervoltage conditions. They are active only when the generator is online. The alarm element is definite time and the trip element can be definite time or a curve. When the magnitude of the average phase-phase voltage is less than the pickup x the generator rated phase-phase voltage, the element will begin to time out. If the time expires, a trip or alarm will occur.

The curve reset rate is a linear reset time from the threshold of trip. If the VT type is selected as None, VT fuse loss is detected, or the magnitude of $I_1 < 7.5\%$ CT, the undervoltage protection is disabled. The pickup levels are insensitive to frequency over the range of 5 to 90 Hz.

The formula for the undervoltage curve is:

$$T = \frac{D}{1 - V/V_{pickup}}, \text{ when } V < V_{pickup}$$

where: T = trip time in seconds
 D = UNDERVOLTAGE TRIP DELAY setpoint
 V = actual per unit phase-phase voltage
 V_{pickup} = UNDERVOLTAGE TRIP PICKUP setpoint

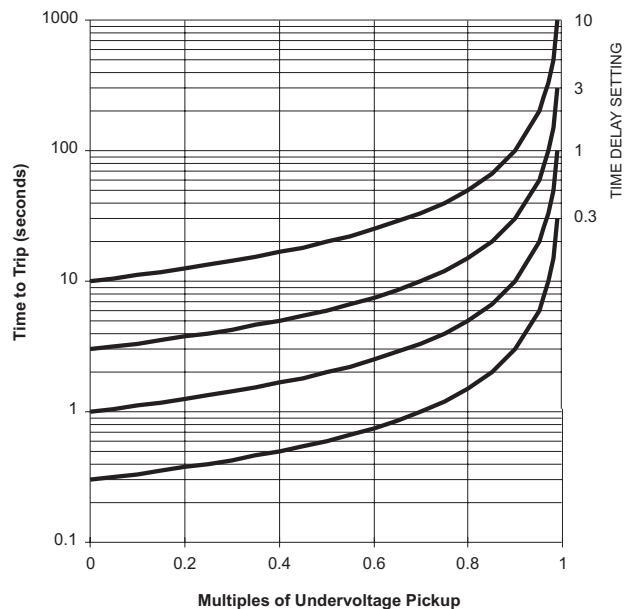

4.7.2 OVERVOLTAGE

<ul style="list-style-type: none"> ■ OVERVOLTAGE ■ [ENTER] for more 	ENTER	OVERVOLTAGE	Range: Off, Latched, Unlatched
	ESCAPE	ALARM: Off	
	ESCAPE	ASSIGN ALARM	Range: Any combination of Relays 2 to 5
	MESSAGE	RELAYS (2-5): ---5	
	ESCAPE	OVERVOLTAGE ALARM	Range: 1.01 to 1.50 x Rated in steps of 0.01
	MESSAGE	PICKUP: 1.15 x Rated	
	ESCAPE	OVERVOLTAGE ALARM	Range: 0.2 to 120.0 s in steps of 0.1
	MESSAGE	DELAY: 3.0 s	
	ESCAPE	OVERVOLTAGE ALARM	Range: On, Off
	MESSAGE	EVENTS: Off	
	ESCAPE	OVERVOLTAGE	Range: Off, Latched, Unlatched
	MESSAGE	TRIP: Off	
	ESCAPE	ASSIGN TRIP	Range: Any combination of Relays 1 to 4
	MESSAGE	RELAYS (1-4): 1---	
ESCAPE	OVERVOLTAGE TRIP	Range: 1.01 to 1.50 x Rated in steps of 0.01	
MESSAGE	PICKUP: 1.20 x Rated		
ESCAPE	OVERVOLTAGE TRIP	Range: 0.1 to 10.0 s in steps of 0.1	
MESSAGE	DELAY: 1.0 s		
ESCAPE	OVERVOLTAGE CURVE	Range: 0.0 to 999.9 s in steps of 0.1	
MESSAGE	RESET RATE: 1.4 s		
ESCAPE	OVERVOLTAGE TRIP	Range: Curve, Definite Time	
MESSAGE	ELEMENT: Curve		

4

The overvoltage elements may be used for protection of the generator and/or its auxiliary equipment during prolonged overvoltage conditions. They are always active (when the generator is offline or online). The alarm element is definite time and the trip element can be either definite time or an inverse time curve. When the average of the measured phase-phase voltages rises above the pickup level x the generator rated phase-phase voltage, the element will begin to time out. If the time expires, a trip or alarm will occur. The reset rate is a linear reset time from the threshold of trip. The pickup levels are insensitive to frequency over the range of 5 to 90 Hz.

The formula for the curve is:

$$T = \frac{D}{(V/V_{pickup}) - 1}, \text{ when } V > V_{pickup}$$

where: T = trip time in seconds
 D = OVERVOLTAGE TRIP DELAY setpoint
 V = actual per unit phase-phase voltage
 V_{pickup} = OVERVOLTAGE TRIP PICKUP setpoint

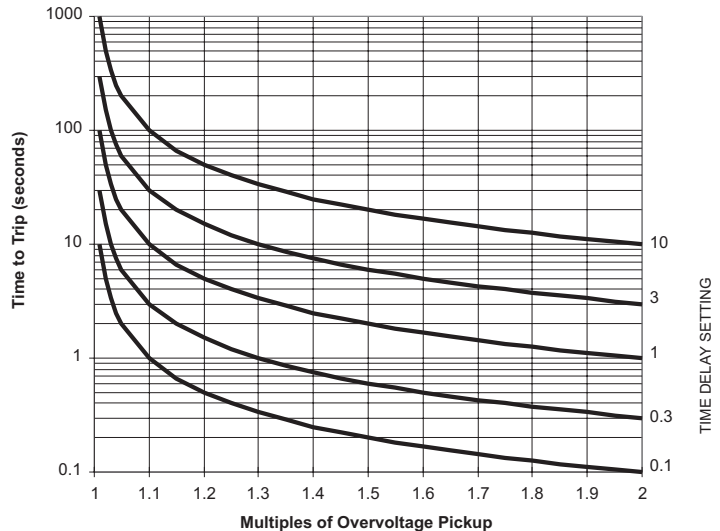

4.7.3 VOLTS/HERTZ

<ul style="list-style-type: none"> ■ VOLTS/HERTZ ■ [ENTER] for more 	[ENTER] → ← [ESCAPE]	VOLTS/HERTZ ALARM: Off	Range: Off, Latched, Unlatched
	↻ [ESCAPE] [MESSAGE] ⇅	ASSIGN ALARM RELAYS (2-5): ---5	Range: Any combination of Relays 2 to 5
	↻ [ESCAPE] [MESSAGE] ⇅	VOLTS/HERTZ ALARM PICKUP: 1.00 x Nominal	Range: 0.50 to 1.99 x Nominal in steps of 0.01
	↻ [ESCAPE] [MESSAGE] ⇅	VOLTS/HERTZ ALARM DELAY: 3.0 s	Range: 0.1 to 150.0 s in steps of 0.1
	↻ [ESCAPE] [MESSAGE] ⇅	VOLTS/HERTZ ALARM EVENTS: Off	Range: On, Off
	↻ [ESCAPE] [MESSAGE] ⇅	VOLTS/HERTZ TRIP: Off	Range: Off, Latched, Unlatched
	↻ [ESCAPE] [MESSAGE] ⇅	ASSIGN TRIP RELAYS (1-4): 1---	Range: Any combination of Relays 1 to 4
	↻ [ESCAPE] [MESSAGE] ⇅	VOLTS/HERTZ TRIP PICKUP: 1.00 x Nominal	Range: 0.50 to 1.99 x Rated in steps of 0.01
	↻ [ESCAPE] [MESSAGE] ⇅	VOLTS/HERTZ TRIP DELAY: 1.0 s	Range: 0.1 to 150.0 s in steps of 0.1
	↻ [ESCAPE] [MESSAGE] ⇅	VOLTS/HERTZ CURVE RESET RATE: 1.4 s	Range: 0.0 to 999.9 s in steps of 0.1
	↻ [ESCAPE] [MESSAGE] ⇅	VOLTS/HERTZ TRIP ELEMENT: Curve #1	Range: Curve #1, Curve #2, Curve #3, Definite Time



The Volts/Hertz elements may be used generator and unit transformer protection. They are active as soon as the magnitude and frequency of V_{ab} is measurable. The alarm element is definite time; the trip element can be definite time or a curve. Once the V/Hz measurement V_{ab} exceeds the pickup level for the specified time, a trip or alarm will occur. The reset rate is a linear reset time from the threshold of trip and should be set to match cooling characteristics of the protected equipment. The measurement of V/Hz will be accurate through a frequency range of 5 to 90 Hz. Settings less than 1.00 only apply for special generators such as short circuit testing machines.

The formula for volts/hertz curve 1 is:

$$T = \frac{D}{\left(\frac{V/F}{(V_{nom}/F_s) \times \text{Pickup}}\right)^2 - 1}, \text{ when } \frac{V}{F} > \text{Pickup}$$

- where: T = trip time in seconds
- D = VOLTS/HERTZ TRIP DELAY setpoint
- V = RMS measurement of V_{ab}
- F = frequency of V_{ab}
- V_{NOM} = generator voltage setpoint
- F_S = generator frequency setpoint
- Pickup = VOLTS/HERTZ TRIP PICKUP setpoint

The V/Hz Curve 1 trip curves are shown on the right for delay settings of 0.1, 0.3, 1, 3, and 10 seconds.

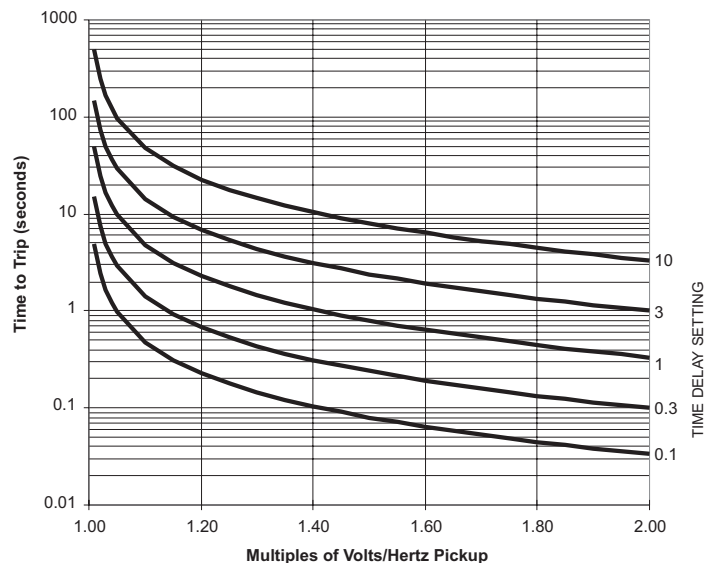

The formula for volts/hertz curve 2 is:

$$T = \frac{D}{\left(\frac{V/F}{(V_{nom}/F_s) \times \text{Pickup}} - 1\right)}, \text{ when } \frac{V}{F} > \text{Pickup}$$

- where: T = trip time in seconds
- D = VOLTS/HERTZ TRIP DELAY setpoint
- V = RMS measurement of Vab
- F = frequency of Vab
- V_{NOM} = generator voltage setpoint
- F_S = generator frequency setpoint
- Pickup = VOLTS/HERTZ TRIP PICKUP setpoint

The V/Hz Curve 2 trip curves are shown on the right for delay settings of 0.1, 0.3, 1, 3, and 10 seconds.

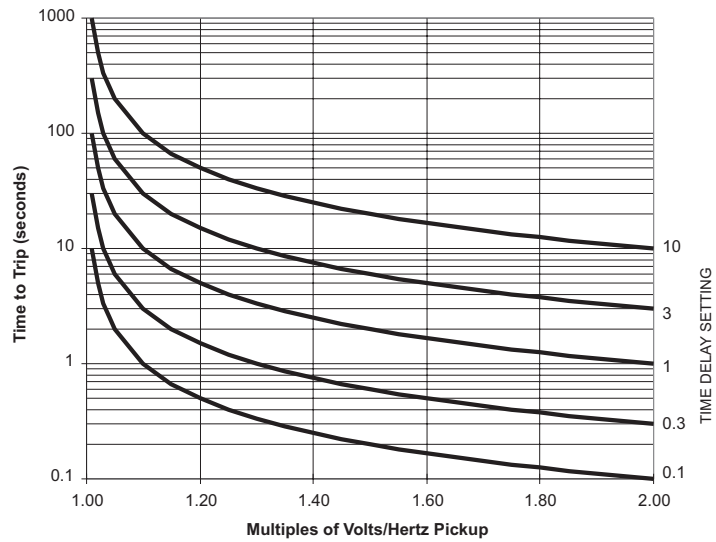

4

The formula for volts/hertz curve 3 is:

$$T = \frac{D}{\left(\frac{V/F}{(V_{nom}/F_s) \times \text{Pickup}}\right)^{0.5} - 1}, \text{ when } \frac{V}{F} > \text{Pickup}$$

- where: T = trip time in seconds
- D = VOLTS/HERTZ TRIP DELAY setpoint
- V = RMS measurement of Vab
- F = frequency of Vab
- V_{NOM} = generator voltage setpoint
- F_S = generator frequency setpoint
- Pickup = VOLTS/HERTZ TRIP PICKUP setpoint

The V/Hz Curve 3 trip curves are shown on the right for delay settings of 0.1, 0.3, 1, 3, and 10 seconds.

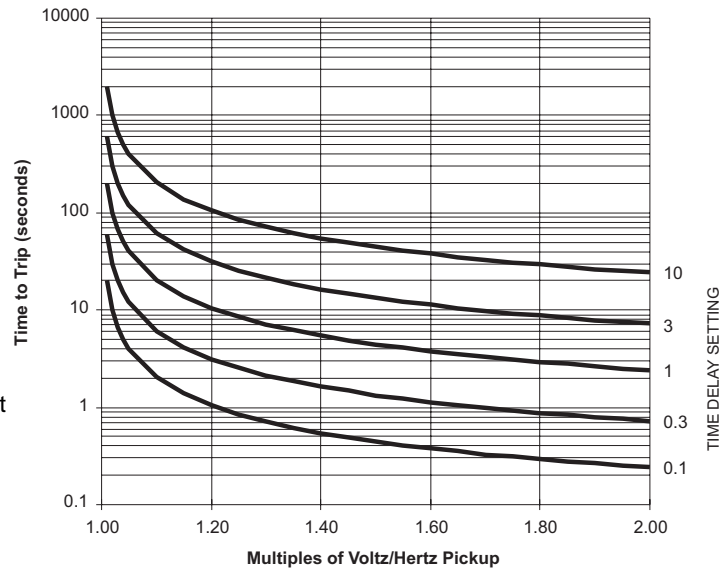

 Volts/Hertz is calculated per unit as follows: $\text{Volts/Hertz} = \frac{\text{phase-phase voltage}/\text{rated phase-phase voltage}}{\text{frequency}/\text{rated frequency}}$

4.7.4 PHASE REVERSAL

<ul style="list-style-type: none"> ■ PHASE REVERSAL ■ [ENTER] for more 	<p>[ENTER] →</p> <p>← [ESCAPE]</p>	<p>PHASE REVERSAL</p> <p>TRIP: Off</p>	<p>Range: Off, Latched, Unlatched</p>
	<p>↖ [ESCAPE]</p> <p>[MESSAGE] ↑</p>	<p>ASSIGN TRIP</p> <p>RELAYS (1-4): 1---</p>	<p>Range: Any combination of Relays 1 to 4</p>

The 489 can detect the phase rotation of the three phase voltages. A trip will occur within 200 ms if the Phase Reversal feature is turned on, the generator is offline, each of the phase-phase voltages is greater than 50% of the generator rated phase-phase voltage and the phase rotation is not the same as the setpoint. Loss of VT fuses cannot be detected when the generator is offline and could lead to maloperation of this element. If the VT type is selected as "None", the phase reversal protection is disabled.

4.7.5 UNDERFREQUENCY

<ul style="list-style-type: none"> ■ UNDERFREQUENCY ■ [ENTER] for more 	[ENTER] → ← [ESCAPE]	BLOCK UNDERFREQUENCY FROM ONLINE: 1 s	<i>Range: 0 to 5 s in steps of 1</i>
	↻ [ESCAPE] [MESSAGE] ⇅	VOLTAGE LEVEL CUTOFF: 0.50 x Rated	<i>Range: 0.50 to 0.99 x Rated in steps of 0.01</i>
	↻ [ESCAPE] [MESSAGE] ⇅	UNDERFREQUENCY ALARM: Off	<i>Range: Off, Latched, Unlatched</i>
	↻ [ESCAPE] [MESSAGE] ⇅	ASSIGN ALARM RELAYS (2-5): ---5	<i>Range: Any combination of Relays 2 to 5</i>
	↻ [ESCAPE] [MESSAGE] ⇅	UNDERFREQUENCY ALARM LEVEL: 59.50 Hz	<i>Range: 20.00 to 60.00 Hz in steps of 0.01</i>
	↻ [ESCAPE] [MESSAGE] ⇅	UNDERFREQUENCY ALARM DELAY: 5.0 s	<i>Range: 0.1 to 5000.0 s in steps of 0.1</i>
	↻ [ESCAPE] [MESSAGE] ⇅	UNDERFREQUENCY ALARM EVENTS: Off	<i>Range: On, Off</i>
	↻ [ESCAPE] [MESSAGE] ⇅	UNDERFREQUENCY TRIP: Off	<i>Range: Off, Latched, Unlatched</i>
	↻ [ESCAPE] [MESSAGE] ⇅	ASSIGN TRIP RELAYS (1-4): 1---	<i>Range: Any combination of Relays 1 to 4</i>
	↻ [ESCAPE] [MESSAGE] ⇅	UNDERFREQUENCY TRIP LEVEL1: 59.50 Hz	<i>Range: 20.00 to 60.00 Hz in steps of 0.01</i>
	↻ [ESCAPE] [MESSAGE] ⇅	UNDERFREQUENCY TRIP DELAY1: 60.0 s	<i>Range: 0.1 to 5000.0 s in steps of 0.1</i>
	↻ [ESCAPE] [MESSAGE] ⇅	UNDERFREQUENCY TRIP LEVEL2: 58.00 Hz	<i>Range: 20.00 to 60.00 Hz in steps of 0.01</i>
	↻ [ESCAPE] [MESSAGE] ⇅	UNDERFREQUENCY TRIP DELAY2: 30.0 s	<i>Range: 0.1 to 5000.0 s in steps of 0.1</i>

It may be undesirable to enable the underfrequency elements until the generator is online. This feature can be blocked until the generator is online and the block time expires. From that point forward, the underfrequency trip and alarm elements will be active. A value of zero for the block time indicates that the underfrequency protection is active as soon as voltage exceeds the cutoff level (programmed as a multiple of the generator rated phase-phase voltage). Frequency is then measured. Once the frequency of V_{ab} is less than the underfrequency setpoints, for the period of time specified, a trip or alarm will occur. There are dual level and time setpoints for the trip element.

4.7.6 OVERFREQUENCY

<ul style="list-style-type: none"> ■ OVERFREQUENCY ■ [ENTER] for more 	ENTER →	BLOCK OVERFREQUENCY	Range: 0 to 5 s in steps of 1
	← ESCAPE	FROM ONLINE: 1 s	
	ESCAPE	VOLTAGE LEVEL	Range: 0.50 to 0.99 × Rated in steps of 0.01
	MESSAGE ↕	CUTOFF: 0.50 x Rated	
	ESCAPE	OVERFREQUENCY	Range: Off, Latched, Unlatched
	MESSAGE ↕	ALARM: Off	
	ESCAPE	ASSIGN ALARM	Range: Any combination of Relays 2 to 5
	MESSAGE ↕	RELAYS (2-5): ---5	
	ESCAPE	OVERFREQUENCY	Range: 25.01 to 70.00 Hz in steps of 0.01
	MESSAGE ↕	ALARM LEVEL: 60.50 Hz	
	ESCAPE	OVERFREQUENCY	Range: 0.1 to 5000.0 s in steps of 0.1
	MESSAGE ↕	ALARM DELAY: 5.0 s	
	ESCAPE	OVERFREQUENCY	Range: On, Off
	MESSAGE ↕	ALARM EVENTS: Off	
ESCAPE	OVERFREQUENCY	Range: Off, Latched, Unlatched	
MESSAGE ↕	TRIP: Off		
ESCAPE	ASSIGN TRIP	Range: Any combination of Relays 1 to 4	
MESSAGE ↕	RELAYS (1-4): 1---		
ESCAPE	OVERFREQUENCY	Range: 25.01 to 70.00 Hz in steps of 0.01	
MESSAGE ↕	TRIP LEVEL1: 60.50 Hz		
ESCAPE	OVERFREQUENCY	Range: 0.1 to 5000.0 s in steps of 0.1	
MESSAGE ↕	TRIP DELAY1: 60.0 s		
ESCAPE	OVERFREQUENCY	Range: 25.01 to 70.00 Hz in steps of 0.01	
MESSAGE ↕	TRIP LEVEL2: 62.00 Hz		
ESCAPE	OVERFREQUENCY	Range: 0.1 to 5000.0 s in steps of 0.1	
MESSAGE ↕	TRIP DELAY2: 30.0 s		

It may be undesirable to enable the overfrequency elements until the generator is online. This feature can be blocked until the generator is online and the block time expires. From that point forward, the overfrequency trip and alarm elements will be active. A value of zero for the block time indicates that the overfrequency protection is active as soon as voltage exceeds the cutoff level (programmed as a multiple of the generator rated phase-phase voltage). Frequency is then measured. Once the frequency of Vab exceeds the overfrequency setpoints, for the period of time specified, a trip or alarm will occur. There are dual level and time setpoints for the trip element.

4.7.7 NEUTRAL OVERVOLTAGE (FUNDAMENTAL)

<ul style="list-style-type: none"> ■ NEUTRAL O/V (FUND) ■ [ENTER] for more 	[ENTER] → [ESCAPE] ←	SUPERVISE WITH DIGITAL INPUT: No	Range: Yes, No. Seen only if a digital input assigned to GROUND SWITCH STATUS
	[ESCAPE] ↶ [MESSAGE] ⇅	NEUTRAL OVERVOLTAGE ALARM: Off	Range: Off, Latched, Unlatched
	[ESCAPE] ↶ [MESSAGE] ⇅	ASSIGN ALARM RELAYS (2-5): ---5	Range: Any combination of Relays 2 to 5
	[ESCAPE] ↶ [MESSAGE] ⇅	NEUTRAL O/V ALARM LEVEL: 3.0 Vsec	Range: 2.0 to 100.0 Vsec in steps of 0.1
	[ESCAPE] ↶ [MESSAGE] ⇅	NEUTRAL OVERVOLTAGE ALARM DELAY: 1.0 s	Range: 0.1 to 120.0 s in steps of 0.1
	[ESCAPE] ↶ [MESSAGE] ⇅	NEUTRAL OVERVOLTAGE ALARM EVENTS: Off	Range: On, Off
	[ESCAPE] ↶ [MESSAGE] ⇅	NEUTRAL OVERVOLTAGE TRIP: Off	Range: Off, Latched, Unlatched
	[ESCAPE] ↶ [MESSAGE] ⇅	ASSIGN TRIP RELAYS (1-4): 1---	Range: Any combination of Relays 1 to 4
	[ESCAPE] ↶ [MESSAGE] ⇅	NEUTRAL O/V TRIP LEVEL: 5.0 Vsec	Range: 2.0 to 100.0 Vsec in steps of 0.1
	[ESCAPE] ↶ [MESSAGE] ⇅	NEUTRAL OVERVOLTAGE TRIP DELAY: 1.0 s	Range: 0.1 to 120.0 s in steps of 0.1
	[ESCAPE] ↶ [MESSAGE] ⇅	NEUTRAL O/V CURVE RESET RATE: 0.0	Range: 0.0 to 999.9 in steps of 0.1
	[ESCAPE] ↶ [MESSAGE] ⇅	NEUTRAL O/V TRIP ELEMENT: Definite Time	Range: Curve, Definite Time



The neutral overvoltage function responds to fundamental frequency voltage at the generator neutral. It provides ground fault protection for approximately 95% of the stator windings. 100% protection is provided when this element is used in conjunction with the Neutral Undervoltage (3rd harmonic) function. The alarm element is definite time and the trip element can be either definite time or an inverse time curve. When the neutral voltage rises above the pickup level the element will begin to time out. If the time expires an alarm or trip will occur. The reset rate is a linear reset time from the threshold of trip. The alarm and trip levels are programmable in terms of Neutral VT secondary voltage.

The formula for the curve is:

$$T = \frac{D}{(V/V_{pickup}) - 1} \quad \text{when } V > V_{pickup}$$

- where
- T = trip time in seconds
 - D = NEUTRAL OVERVOLTAGE TRIP DELAY setpoint
 - V = neutral voltage
 - V_{pickup} = NEUTRAL O/V TRIP LEVEL setpoint

The neutral overvoltage curves are shown on the right. Refer to Appendix B for Application Notes.

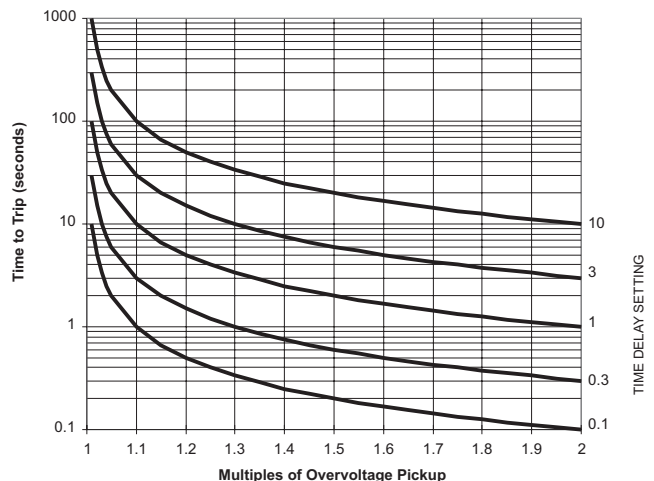

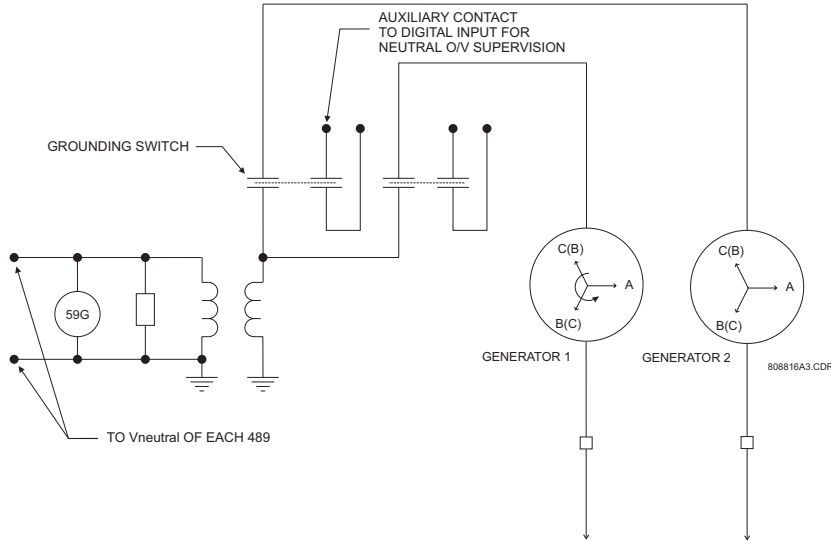

Figure 4-6: NEUTRAL OVERVOLTAGE DETECTION

4



If the ground directional element is enabled, the Neutral Overvoltage element should be coordinated with it. In cases of paralleled generator grounds through the same point, with individual ground switches, per sketch below, it is recommended to use a ground switch status function to prevent maloperation of the element.

4.7.8 NEUTRAL UNDERVOLTAGE (3RD HARMONIC)

<ul style="list-style-type: none"> ■ NEUTRAL U/V (3rd) ■ [ENTER] for more 	<p>[ENTER] →</p> <p>[ESCAPE] ←</p>	<p>LOW POWER BLOCKING</p> <p>LEVEL: 0.05 x Rated MW</p>	<p>Range: 0.02 to 0.99 x Rated MW in steps of 0.01</p> <p>Seen only if VT CONNECTION is Delta</p>
	<p>[ESCAPE] ↻</p> <p>[MESSAGE] ⇅</p>	<p>LOW VOLTAGE BLOCKING</p> <p>LEVEL: 0.75 x Rated</p>	<p>Range: 0.50 to 1.00 x Rated in steps of 0.01</p> <p>Seen only if VT CONNECTION is Delta</p>
	<p>[ESCAPE] ↻</p> <p>[MESSAGE] ⇅</p>	<p>NEUTRAL UNDERVOLTAGE</p> <p>ALARM: Off</p>	<p>Range: Off, Latched, Unlatched</p>
	<p>[ESCAPE] ↻</p> <p>[MESSAGE] ⇅</p>	<p>ASSIGN ALARM</p> <p>RELAYS (2-5): ---5</p>	<p>Range: Any combination of Relays 2 to 5</p>
	<p>[ESCAPE] ↻</p> <p>[MESSAGE] ⇅</p>	<p>NEUTRAL U/V ALARM</p> <p>LEVEL: 0.5 Vsec</p>	<p>Range: 0.5 to 20.0 Vsec in steps of 0.1</p> <p>Seen only if VT CONNECTION is Delta</p>
	<p>[ESCAPE] ↻</p> <p>[MESSAGE] ⇅</p>	<p>NEUTRAL UNDERVOLTAGE</p> <p>ALARM DELAY: 30 s</p>	<p>Range: 5 to 120 s in steps of 1</p>
	<p>[ESCAPE] ↻</p> <p>[MESSAGE] ⇅</p>	<p>NEUTRAL UNDERVOLTAGE</p> <p>ALARM EVENTS: Off</p>	<p>Range: On, Off</p>
	<p>[ESCAPE] ↻</p> <p>[MESSAGE] ⇅</p>	<p>NEUTRAL UNDERVOLTAGE</p> <p>TRIP: Off</p>	<p>Range: Off, Latched, Unlatched</p>
	<p>[ESCAPE] ↻</p> <p>[MESSAGE] ⇅</p>	<p>ASSIGN TRIP</p> <p>RELAYS (1-4): 1---</p>	<p>Range: Any combination of Relays 1 to 4</p>
	<p>[ESCAPE] ↻</p> <p>[MESSAGE] ⇅</p>	<p>NEUTRAL U/V TRIP</p> <p>LEVEL: 1.0 Vsec</p>	<p>Range: 0.5 to 20.0 Vsec in steps of 0.1</p> <p>Seen only if VT CONNECTION is Delta</p>
	<p>[ESCAPE] ↻</p> <p>[MESSAGE] ⇅</p>	<p>NEUTRAL UNDERVOLTAGE</p> <p>TRIP DELAY: 30 s</p>	<p>Range: 5 to 120 s in steps of 1</p>

The neutral undervoltage function responds to 3rd harmonic voltage measured at the generator neutral and output terminals. When used in conjunction with the Neutral Overvoltage (fundamental frequency) function, it provides 100% ground fault protection of the stator windings.

WYE CONNECTED VTS:

Since the amount of third harmonic voltage that appears in the neutral is both load and machine dependent, the protection method of choice is an adaptive method. If the phase VT connection is wye, the following formula is used to create an adaptive neutral undervoltage pickup level based on the amount of third harmonic that appears at the generator terminals.

$$\frac{V_{N3}}{(V_{P3}/3) + V_{N3}} \leq 0.15 \quad \text{which simplifies to} \quad V_{P3} \geq 17 V_{N3}$$

The 489 tests the following permissives prior to testing the basic operating equation to ensure that V_{N3}' should be of a measurable magnitude for an unfaulted generator:

$$V_{P3}' > 0.25 \text{ volts} \quad \text{and} \quad V_{P3}' \geq \text{Permissive Threshold} \times 17 \times \frac{\text{Neutral VT Ratio}}{\text{Phase VT Ratio}}$$

where: V_{N3} = the magnitude of the third harmonic voltage at generator neutral
 V_{P3} = the magnitude of the third harmonic voltage at the generator terminals
 V_{P3}' = the VT secondary magnitude of the third harmonic voltage measured at the generator terminals
 V_{N3}' = the VT secondary magnitude of the third harmonic voltage at generator neutral
 Permissive Threshold = 0.15 volts for the alarm element and 0.1875 volts for the trip element

Refer to Appendix B for Application Notes.

OPEN DELTA CONNECTED VTS:

If the phase VT connection is open delta, it is not possible to measure the third harmonic voltages at the generator terminals and a simple third harmonic neutral undervoltage element is used. The level is programmable in terms of Neutral VT secondary voltage. In order to prevent nuisance tripping at low load or low generator voltages, two blocking functions are provided. They apply to both the alarm and trip functions. When used as a simple undervoltage element, settings should be based on measured 3rd harmonic neutral voltage of the healthy machine.



This method of using 3rd harmonic voltages to detect stator ground faults near the generator neutral has proved feasible on generators with unit transformers. Its usefulness in other generator applications is unknown.

NOTE

4.7.9 LOSS OF EXCITATION

<p>■ LOSS OF EXCITATION</p> <p>■ [ENTER] for more</p>	ENTER →	ENABLE VOLTAGE SUPERVISION: Yes	Range: Yes, No
	← ESCAPE		
	ESCAPE ↻	VOLTAGE LEVEL: 0.70 x Rated	Range: 0.70 to 1.00 x Rated in steps of 0.01. Seen only if ENABLE VOLTAGE SUPERVISION is Yes
	MESSAGE ↕		
	ESCAPE ↻	CIRCLE 1 TRIP: Off	Range: Off, Latched, Unlatched
	MESSAGE ↕		
	ESCAPE ↻	ASSIGN CIRCLE 1 TRIP RELAYS (1-4): 1---	Range: Any combination of Relays 1 to 4
	MESSAGE ↕		
	ESCAPE ↻	CIRCLE 1 DIAMETER: 25.0 Ωsec	Range: 2.5 to 300.0 Ωsec in steps of 0.1
	MESSAGE ↕		
	ESCAPE ↻	CIRCLE 1 OFFSET: 2.5 Ωsec	Range: 1.0 to 300.0 Ωsec in steps of 0.1
	MESSAGE ↕		
	ESCAPE ↻	CIRCLE 1 TRIP DELAY: 5.0 s	Range: 0.1 to 10.0 s in steps of 0.1
	MESSAGE ↕		
ESCAPE ↻	CIRCLE 2 TRIP: Off	Range: Off, Latched, Unlatched	
MESSAGE ↕			
ESCAPE ↻	ASSIGN CIRCLE 2 TRIP RELAYS (1-4): 1---	Range: Any combination of Relays 1 to 4	
MESSAGE ↕			
ESCAPE ↻	CIRCLE 2 DIAMETER: 35.0 Ωsec	Range: 2.5 to 300.0 Ωsec in steps of 0.1	
MESSAGE ↕			
ESCAPE ↻	CIRCLE 2 OFFSET: 2.5 Ωsec	Range: 1.0 to 300.0 Ωsec in steps of 0.1	
MESSAGE ↕			
ESCAPE ↻	CIRCLE 2 TRIP DELAY: 5.0 s	Range: 0.1 to 10.0 s in steps of 0.1	
MESSAGE ↕			

4

Loss of excitation is detected with an impedance element. When the impedance falls within the impedance circle for the specified delay time, a trip will occur if it is enabled. Circles 1 and/or 2 can be tuned to a particular system. The larger circle diameter should be set to the synchronous reactance of the generator, x_d , and the circle offset to the generator transient reactance $x'_d/2$. Typically the smaller circle (if used) is set to minimum time with a diameter set to $0.7x_d$ and an offset of $x'_d/2$. This feature is blocked if voltage supervision is enabled and the generator voltage is above the **VOLTAGE LEVEL** setpoint. The trip feature is supervised by minimum current of $0.05 \times CT$. Note that the Loss of Excitation element will be blocked if there is a VT fuse failure or if the generator is offline. Also, it uses output CT inputs.

The secondary phase-phase loss of excitation impedance is defined as:

$$Z_{loe} = \frac{V_{AB}}{I_A - I_B} = M_{loe} \angle \theta_{loe}$$

where: Z_{loe} = secondary phase-to-phase loss of excitation impedance
 $M_{loe} \angle \theta_{loe}$ = Secondary impedance phasor (magnitude and angle)

All relay quantities are in terms of secondary impedances. The formula to convert primary impedance quantities to secondary impedance quantities is provided below.

$$Z_{secondary} = \frac{Z_{primary} \times CT \text{ Ratio}}{VT \text{ Ratio}}$$

where: $Z_{primary}$ = primary ohms impedance
 CT Ratio = programmed CT ratio, if CT ratio is 1200:5 use a value of $1200 / 5 = 240$
 VT Ratio = programmed VT ratio, if VT ratio is 100:1 use a value of 100

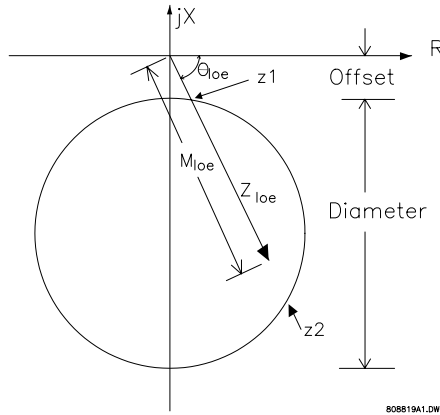

Figure 4-7: LOSS OF EXCITATION R-X DIAGRAM

4.7.10 DISTANCE ELEMENTS

<ul style="list-style-type: none"> ■ DISTANCE ELEMENT ■ [ENTER] for more 	[ENTER] → ← [ESCAPE]	STEP UP TRANSFORMER SETUP: None	Range: None, Delta/Wye
	↻ [ESCAPE] [MESSAGE] ⇅	FUSE FAILURE SUPERVISION: On	Range: On, Off
	↻ [ESCAPE] [MESSAGE] ⇅	ZONE #1 TRIP: Off	Range: Off, Latched, Unlatched
	↻ [ESCAPE] [MESSAGE] ⇅	ASSIGN ZONE #1 TRIP RELAYS (1-4): 1---	Range: Any combination of Relays 1 to 4
	↻ [ESCAPE] [MESSAGE] ⇅	ZONE #1 REACH: 10.0 Ωsec	Range: 0.1 to 500.0 Ωsec in steps of 0.1
	↻ [ESCAPE] [MESSAGE] ⇅	ZONE #1 ANGLE: 75°	Range: 50 to 85° in steps of 1
	↻ [ESCAPE] [MESSAGE] ⇅	ZONE #1 TRIP DELAY: 0.4 s	Range: 0.0 to 150.0 s in steps of 0.1
	↻ [ESCAPE] [MESSAGE] ⇅	ZONE #2 TRIP: Off	Range: Off, Latched, Unlatched
	↻ [ESCAPE] [MESSAGE] ⇅	ASSIGN ZONE #2 TRIP RELAYS (1-4): 1---	Range: Any combination of Relays 1 to 4
	↻ [ESCAPE] [MESSAGE] ⇅	ZONE #2 REACH: 15.0 Ωsec	Range: 0.1 to 500.0 Ωsec in steps of 0.1
	↻ [ESCAPE] [MESSAGE] ⇅	ZONE #2 ANGLE: 75°	Range: 50 to 85° in steps of 1
	↻ [ESCAPE] [MESSAGE] ⇅	ZONE #2 TRIP DELAY: 2.0 s	Range: 0.0 to 150.0 s in steps of 0.1

The distance protection function (ANSI device 21) implements two zones of mho phase-to-phase distance protection (six elements total) using the conventional phase comparator approach, with the polarizing voltage derived from the pre-fault positive sequence voltage of the protected loop. This protection is intended as backup for the primary line protection. The elements make use of the neutral-end current signals and the generator terminal voltage signals (see figure below), thus providing some protection for internal and unit transformer faults. In systems with a delta-wye transformer (DY330°), the appropriate transformations of voltage and current signals are implemented internally to allow proper detection of trans-

former high-side phase-to-phase faults. The reach setting is the positive sequence impedance to be covered, per phase, expressed in secondary ohms. The same transformation shown for the Loss of Excitation element can be used to calculate the desired settings as functions of the primary-side impedances.

The elements have a basic operating time of 150 ms. A VT fuse failure could cause a maloperation of a distance element unless the element is supervised by the VTFF element. In order to prevent nuisance tripping the elements require a minimum phase current of $0.05 \times CT$.

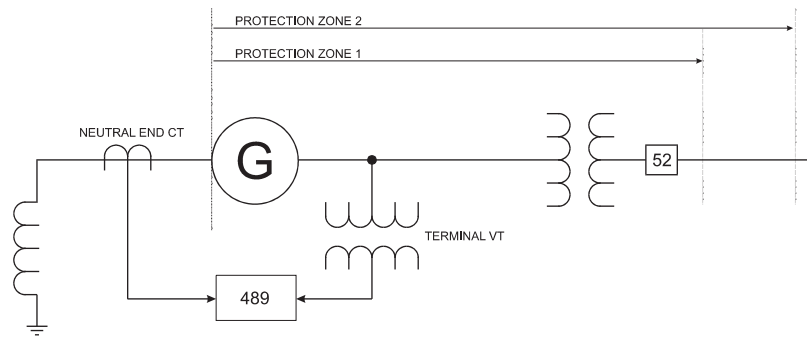

Figure 4-8: DISTANCE ELEMENT SETUP

4.8.1 POWER MEASUREMENT CONVENTIONS

Generation of power will be displayed on the 489 as positive watts. By convention, an induction generator normally requires reactive power from the system for excitation. This is displayed on the 489 as negative vars. A synchronous generator on the other hand has its own source of excitation and can be operated with either lagging or leading power factor. This is displayed on the 489 as positive vars and negative vars, respectively. All power quantities are measured from the phase-phase voltage and the currents measured at the output CTs.

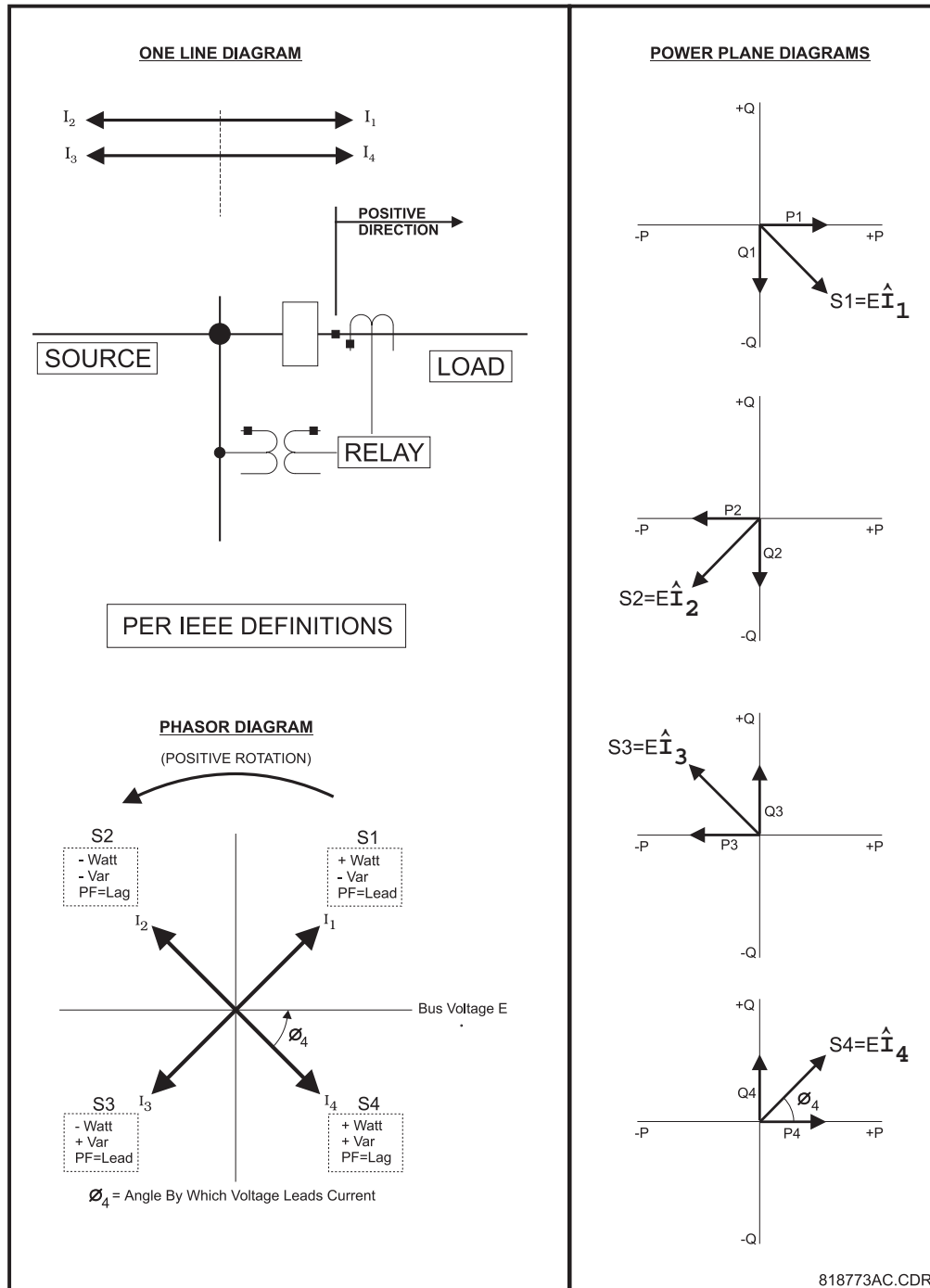

Figure 4-9: POWER MEASUREMENT CONVENTIONS

4.8.2 REACTIVE POWER

<ul style="list-style-type: none"> ■ REACTIVE POWER ■ [ENTER] for more 	ENTER →	BLOCK Mvar ELEMENT	Range: 0 to 5000 s in steps of 1
	← ESCAPE	FROM START: 1 s	
	ESCAPE	REACTIVE POWER	Range: Off, Latched, Unlatched
	MESSAGE ↕	ALARM: Off	
	ESCAPE	ASSIGN ALARM	Range: Any combination of Relays 2 to 5
	MESSAGE ↕	RELAYS (2-5): ---5	
	ESCAPE	POSITIVE Mvar ALARM	Range: 0.02 to 1.50 × Rated in steps of 0.01
	MESSAGE ↕	LEVEL: 0.85 x Rated	
	ESCAPE	NEGATIVE Mvar ALARM	Range: 0.02 to 1.50 × Rated in steps of 0.01
	MESSAGE ↕	LEVEL: 0.85 x Rated	
	ESCAPE	POSITIVE Mvar ALARM	Range: 0.2 to 120.0 s in steps of 0.1
	MESSAGE ↕	DELAY: 10.0 s	Note: Lagging vars, overexcited
	ESCAPE	NEGATIVE Mvar ALARM	Range: 0.2 to 120.0 s in steps of 0.1
	MESSAGE ↕	DELAY: 1.0 s	Note: Leading vars, underexcited
ESCAPE	REACTIVE POWER ALARM	Range: On, Off	
MESSAGE ↕	EVENTS: Off		
ESCAPE	REACTIVE POWER	Range: Off, Latched, Unlatched	
MESSAGE ↕	TRIP: Off		
ESCAPE	ASSIGN TRIP	Range: Any combination of Relays 1 to 4	
MESSAGE ↕	RELAYS (1-4): 1---		
ESCAPE	POSITIVE Mvar TRIP	Range: 0.02 to 1.50 × Rated in steps of 0.01	
MESSAGE ↕	LEVEL: 0.80 x Rated		
ESCAPE	NEGATIVE Mvar TRIP	Range: 0.02 to 1.50 × Rated in steps of 0.01	
MESSAGE ↕	LEVEL: 0.80 x Rated		
ESCAPE	POSITIVE Mvar TRIP	Range: 0.2 to 120.0 s in steps of 0.1	
MESSAGE ↕	DELAY: 20.0 s	Note: Lagging vars, overexcited	
ESCAPE	NEGATIVE Mvar TRIP	Range: 0.2 to 120.0 s in steps of 0.1	
MESSAGE ↕	DELAY: 20.0 s	Note: Leading vars, underexcited	

In a motor/generator application, it may be desirable not to trip or alarm on reactive power until the machine is online and the field has been applied. Therefore, this feature can be blocked until the machine is online and adequate time has expired during which the field had been applied. From that point forward, the reactive power trip and alarm elements will be active. A value of zero for the block time indicates that the reactive power protection is active as soon as both current and voltage are measured regardless of whether the generator is online or offline. Once the 3-phase total reactive power exceeds the positive or negative level, for the specified delay, a trip or alarm will occur indicating a positive or negative Mvar condition. The level is programmed in per unit of generator rated Mvar calculated from the rated MVA and rated power factor. The reactive power elements can be used to detect loss of excitation. If the VT type is selected as "None" or VT fuse loss is detected, the reactive power protection is disabled. Rated Mvars for the system can be calculated as follows:

For example, given Rated MVA = 100 MVA and Rated Power Factor = 0.85, we have

$$\text{Rated Mvars} = \text{Rated MVA} \times \sin(\cos^{-1}(\text{Rated PF})) = 100 \times \sin(\cos^{-1}(0.85)) = 52.67 \text{ Mvars}$$

4.8.3 REVERSE POWER

<ul style="list-style-type: none"> ■ REVERSE POWER ■ [ENTER] for more 	ENTER →	BLOCK REVERSE POWER FROM ONLINE: 1 s	Range: 0 to 5000 s in steps of 1
	← ESCAPE	REVERSE POWER ALARM: Off	Range: Off, Latched, Unlatched
	ESCAPE MESSAGE ↕	ASSIGN ALARM RELAYS (2-5): ---5	Range: Any combination of Relays 2 to 5
	ESCAPE MESSAGE ↕	REVERSE POWER ALARM LEVEL: 0.05 x Rated MW	Range: 0.02 to 0.99 x Rated MW in steps of 0.01
	ESCAPE MESSAGE ↕	REVERSE POWER ALARM DELAY: 10.0 s	Range: 0.2 to 120.0 s in steps of 0.1
	ESCAPE MESSAGE ↕	REVERSE POWER ALARM EVENTS: Off	Range: On, Off
	ESCAPE MESSAGE ↕	REVERSE POWER TRIP: Off	Range: Off, Latched, Unlatched
	ESCAPE MESSAGE ↕	ASSIGN TRIP RELAYS (1-4): 1---	Range: Any combination of Relays 1 to 4
	ESCAPE MESSAGE ↕	REVERSE POWER TRIP LEVEL: 0.05 x Rated MW	Range: 0.02 to 0.99 x Rated MW in steps of 0.01
	ESCAPE MESSAGE ↕	REVERSE POWER TRIP DELAY: 20.0 s	Range: 0.2 to 120.0 s in steps of 0.1



If enabled, once the magnitude of 3-phase total power exceeds the Pickup Level in the reverse direction (negative MW) for a period of time specified by the Delay, a trip or alarm will occur. The level is programmed in per unit of generator rated MW calculated from the rated MVA and rated power factor. If the generator is accelerated from the power system rather than the prime mover, the reverse power element may be blocked from start for a specified period of time. A value of zero for the block time indicates that the reverse power protection is active as soon as both current and voltage are measured regardless of whether the generator is online or offline. If the VT type is selected as "None" or VT fuse loss is detected, the reverse power protection is disabled.



The minimum magnitude of power measurement is determined by the phase CT minimum of 2% rated CT primary. If the level for reverse power is set below that level, a trip or alarm will only occur once the phase current exceeds the 2% cutoff.

Users are cautioned that a reverse power element may not provide reliable indication when set to a very low setting, particularly under conditions of large reactive loading on the generator. Under such conditions, low forward power is a more reliable element.

4.8.4 LOW FORWARD POWER

<ul style="list-style-type: none"> ■ LOW FORWARD POWER ■ [ENTER] for more 	ENTER →	BLOCK LOW FWD POWER	Range: 0 to 15000 s in steps of 1
	← ESCAPE	FROM ONLINE: 0 s	
	ESCAPE	LOW FORWARD POWER	Range: Off, Latched, Unlatched
	MESSAGE ↕	ALARM: Off	
	ESCAPE	ASSIGN ALARM	Range: Any combination of Relays 2 to 5
	MESSAGE ↕	RELAYS (2-5): ---5	
	ESCAPE	LOW FWD POWER ALARM	Range: 0.02 to 0.99 × Rated MW in steps of 0.01
	MESSAGE ↕	LEVEL: 0.05 x Rated MW	
	ESCAPE	LOW FWD POWER ALARM	Range: 0.2 to 120.0 s in steps of 0.1
	MESSAGE ↕	DELAY: 10.0 s	
ESCAPE	LOW FWD POWER ALARM	Range: On, Off	
MESSAGE ↕	EVENTS: Off		
ESCAPE	LOW FORWARD POWER	Range: Off, Latched, Unlatched	
MESSAGE ↕	TRIP: Off		
ESCAPE	ASSIGN TRIP	Range: Any combination of Relays 1 to 4	
MESSAGE ↕	RELAYS (1-4): 1---		
ESCAPE	LOW FWD POWER TRIP	Range: 0.02 to 0.99 × Rated MW in steps of 0.01	
MESSAGE ↕	LEVEL: 0.05 x Rated MW		
ESCAPE	LOW FWD POWER TRIP	Range: 0.2 to 120.0 s in steps of 0.1	
MESSAGE ↕	DELAY: 20.0 s		

If enabled, once the magnitude of 3-phase total power in the forward direction (+MW) falls below the Pickup Level for a period of time specified by the Delay, an alarm will occur. The level is programmed in per unit of generator rated MW calculated from the rated MVA and rated power factor. The low forward power element is active only when the generator is online and will be blocked until the generator is brought online, for a period of time defined by the setpoint Block Low Fwd Power From Online. The pickup level should be set lower than expected generator loading during normal operations. If the VT type is selected as "None" or VT fuse loss is detected, the low forward power protection is disabled.

4

4.9.1 RTD TYPES

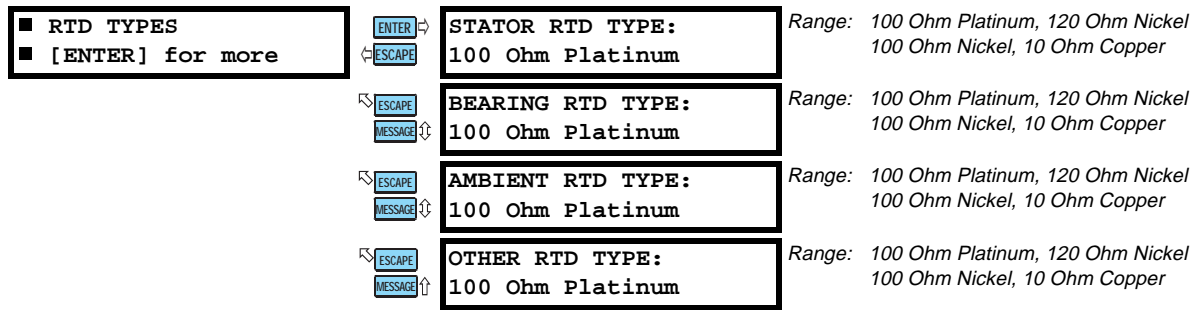

Each of the twelve RTDs may be configured as None or any one of four application types, Stator, Bearing, Ambient, or Other. Each of those types may in turn be any one of four different RTD types: 100 ohm Platinum, 120 ohm Nickel, 100 ohm Nickel, 10 ohm Copper. The table below lists RTD resistance vs. temperature.

Table 4-6: RTD TEMPERATURE VS. RESISTANCE

TEMP °CELSIUS	TEMP °FAHRENHEIT	100 Ω PT (DIN 43760)	120 Ω NI	100 Ω NI	10 Ω CU
-50	-58	80.31	86.17	71.81	7.10
-40	-40	84.27	92.76	77.30	7.49
-30	-22	88.22	99.41	82.84	7.88
-20	-4	92.16	106.15	88.45	8.26
-10	14	96.09	113.00	94.17	8.65
0	32	100.00	120.00	100.00	9.04
10	50	103.90	127.17	105.97	9.42
20	68	107.79	134.52	112.10	9.81
30	86	111.67	142.06	118.38	10.19
40	104	115.54	149.79	124.82	10.58
50	122	119.39	157.74	131.45	10.97
60	140	123.24	165.90	138.25	11.35
70	158	127.07	174.25	145.20	11.74
80	176	130.89	182.84	152.37	12.12
90	194	134.70	191.64	159.70	12.51
100	212	138.50	200.64	167.20	12.90
110	230	142.29	209.85	174.87	13.28
120	248	146.06	219.29	182.75	13.67
130	266	149.82	228.96	190.80	14.06
140	284	153.58	238.85	199.04	14.44
150	302	157.32	248.95	207.45	14.83
160	320	161.04	259.30	216.08	15.22
170	338	164.76	269.91	224.92	15.61
180	356	168.47	280.77	233.97	16.00
190	374	172.46	291.96	243.30	16.39
200	392	175.84	303.46	252.88	16.78
210	410	179.51	315.31	262.76	17.17
220	428	183.17	327.54	272.94	17.56
230	446	186.82	340.14	283.45	17.95
240	464	190.45	353.14	294.28	18.34
250	482	194.08	366.53	305.44	18.73



<ul style="list-style-type: none"> ■ RTD #1 ■ [ENTER] for more 	ENTER →	RTD #1 APPLICATION: Stator	Range: Stator, Bearing, Ambient, Other, None
	← ESCAPE	RTD #1 NAME:	Range: 8 alphanumeric characters
	ESCAPE MESSAGE ↕	RTD #1 ALARM: Off	Range: Off, Latched, Unlatched
	ESCAPE MESSAGE ↕	ASSIGN ALARM RELAYS (2-5): ---5	Range: Any combination of Relays 2 to 5.
	ESCAPE MESSAGE ↕	RTD #1 ALARM TEMPERATURE: 130°C	Range: 1 to 250°C in steps of 1
	ESCAPE MESSAGE ↕	RTD #1 ALARM EVENTS: Off	Range: On, Off
	ESCAPE MESSAGE ↕	RTD #1 TRIP: Off	Range: Off, Latched, Unlatched
	ESCAPE MESSAGE ↕	RTD #1 TRIP VOTING: RTD #1	Range: RTD #1 to RTD #12
	ESCAPE MESSAGE ↕	ASSIGN TRIP RELAYS (1-4): 1---	Range: Any combination of Relays 1 to 4
	ESCAPE MESSAGE ↕	RTD #1 TRIP TEMPERATURE: 155°C	Range: 1 to 250°C in steps of 1

RTDs 1 through 6 default to Stator RTD type. There are individual alarm and trip configurations for each RTD. This allows one of the RTDs to be turned off if it malfunctions. The alarm level is normally set slightly above the normal running temperature. The trip level is normally set at the insulation rating. Trip voting has been added for extra reliability in the event of RTD malfunction. If enabled, a second RTD must also exceed the trip temperature of the RTD being checked before a trip will be issued. If the RTD is chosen to vote with itself, the voting feature is disabled. Each RTD name may be changed if desired.

<ul style="list-style-type: none"> ■ RTD #7 ■ [ENTER] for more 	[ENTER] →	RTD #7 APPLICATION:	<i>Range: Stator, Bearing, Ambient, Other, None</i>
	← [ESCAPE]	Bearing	
	↻ [ESCAPE]	RTD #7 NAME:	<i>Range: 8 alphanumeric characters</i>
	MESSAGE ↕		
	↻ [ESCAPE]	RTD #7 ALARM:	<i>Range: Off, Latched, Unlatched</i>
	MESSAGE ↕	Off	
	↻ [ESCAPE]	ASSIGN ALARM	<i>Range: Any combination of Relays 2 to 5.</i>
	MESSAGE ↕	RELAYS (2-5): ---5	
	↻ [ESCAPE]	RTD #7 ALARM	<i>Range: 1 to 250°C in steps of 1</i>
	MESSAGE ↕	TEMPERATURE: 80°C	
↻ [ESCAPE]	RTD #7 ALARM	<i>Range: On, Off</i>	
MESSAGE ↕	EVENTS: Off		
↻ [ESCAPE]	RTD #7 TRIP:	<i>Range: Off, Latched, Unlatched</i>	
MESSAGE ↕	Off		
↻ [ESCAPE]	RTD #7 TRIP VOTING:	<i>Range: RTD #1 to RTD #12</i>	
MESSAGE ↕	RTD #7		
↻ [ESCAPE]	ASSIGN TRIP	<i>Range: Any combination of Relays 1 to 4</i>	
MESSAGE ↕	RELAYS (1-4): 1---		
↻ [ESCAPE]	RTD #7 TRIP	<i>Range: 1 to 250°C in steps of 1</i>	
MESSAGE ↕	TEMPERATURE: 90°C		



RTDs 7 through 10 default to Bearing RTD type. There are individual alarm and trip configurations for each RTD. This allows one of the RTDs to be turned off if it malfunctions. The alarm level and the trip level are normally set slightly above the normal running temperature, but below the bearing temperature rating. Trip voting has been added for extra reliability in the event of RTD malfunction. If enabled, a second RTD must also exceed the trip temperature of the RTD being checked before a trip will be issued. If the RTD is chosen to vote with itself, the voting feature is disabled. Each RTD name may be changed if desired.

<ul style="list-style-type: none"> ■ RTD #11 ■ [ENTER] for more 	ENTER →	RTD #11 APPLICATION: Other	Range: Stator, Bearing, Ambient, Other, None
	← ESCAPE	RTD #11 NAME:	Range: 8 alphanumeric characters
	ESCAPE MESSAGE ↕	RTD #11 ALARM: Off	Range: Off, Latched, Unlatched
	ESCAPE MESSAGE ↕	ASSIGN ALARM RELAYS (2-5): ---5	Range: Any combination of Relays 2 to 5.
	ESCAPE MESSAGE ↕	RTD #11 ALARM TEMPERATURE: 80°C	Range: 1 to 250°C in steps of 1
	ESCAPE MESSAGE ↕	RTD #11 ALARM EVENTS: Off	Range: On, Off
	ESCAPE MESSAGE ↕	RTD #11 TRIP: Off	Range: Off, Latched, Unlatched
	ESCAPE MESSAGE ↕	RTD #11 TRIP VOTING: RTD #11	Range: RTD #1 to RTD #12
	ESCAPE MESSAGE ↕	ASSIGN TRIP RELAYS (1-4): 1---	Range: Any combination of Relays 1 to 4
	ESCAPE MESSAGE ↕	RTD #11 TRIP TEMPERATURE: 90°C	Range: 1 to 250°C in steps of 1

RTD 11 defaults to Other RTD type. The Other selection allows the RTD to be used to monitor any temperature that might be required, either for a process or additional bearings or other. There are individual alarm and trip configurations for this RTD. Trip voting has been added for extra reliability in the event of RTD malfunction. If enabled, a second RTD must also exceed the trip temperature of the RTD being checked before a trip will be issued. If the RTD is chosen to vote with itself, the voting feature is disabled. The RTD name may be changed if desired.

<ul style="list-style-type: none"> ■ RTD #12 ■ [ENTER] for more 	ENTER →	RTD #12 APPLICATION: Ambient	Range: Stator, Bearing, Ambient, Other, None
	← ESCAPE	RTD #12 NAME:	Range: 8 alphanumeric characters
	↻ ESCAPE MESSAGE ↕	RTD #12 ALARM: Off	Range: Off, Latched, Unlatched
	↻ ESCAPE MESSAGE ↕	ASSIGN ALARM RELAYS (2-5): ---5	Range: Any combination of Relays 2 to 5.
	↻ ESCAPE MESSAGE ↕	RTD #12 ALARM TEMPERATURE: 60°C	Range: 1 to 250°C in steps of 1
	↻ ESCAPE MESSAGE ↕	RTD #12 ALARM EVENTS: Off	Range: On, Off
	↻ ESCAPE MESSAGE ↕	RTD #12 TRIP: Off	Range: Off, Latched, Unlatched
	↻ ESCAPE MESSAGE ↕	RTD #12 TRIP VOTING: RTD #12	Range: RTD #1 to RTD #12
	↻ ESCAPE MESSAGE ↕	ASSIGN TRIP RELAYS (1-4): 1---	Range: Any combination of Relays 1 to 4
	↻ ESCAPE MESSAGE ↕	RTD #12 TRIP TEMPERATURE: 80°C	Range: 1 to 250°C in steps of 1

RTDs 12 defaults to Ambient RTD type. The Ambient selection allows the RTD to be used to monitor ambient temperature. There are individual alarm and trip configurations for this RTD. Trip voting has been added for extra reliability in the event of RTD malfunction. If enabled, a second RTD must also exceed the trip temperature of the RTD being checked before a trip will be issued. If the RTD is chosen to vote with itself, the voting feature is disabled. The RTD name may be changed if desired.

4.9.6 OPEN RTD SENSOR

<ul style="list-style-type: none"> ■ OPEN RTD SENSOR ■ [ENTER] for more 	ENTER →	OPEN RTD SENSOR: Off	Range: Off, Latched, Unlatched
	← ESCAPE	ASSIGN ALARM RELAYS (2-5): ---5	Range: Any combination of Relays 2 to 5
	↻ ESCAPE MESSAGE ↕	OPEN RTD SENSOR ALARM EVENTS: Off	Range: On, Off

The 489 has an Open RTD Sensor Alarm. This alarm will look at all RTDs that have either an alarm or trip programmed and determine if an RTD connection has been broken. Any RTDs that do not have a trip or alarm associated with them will be ignored for this feature. When a broken sensor is detected, the assigned output relay will operate and a message will appear on the display identifying the RTD that is broken. It is recommended that if this feature is used, the alarm be programmed as latched so that intermittent RTDs are detected and corrective action may be taken.



4.9.7 RTD SHORT/LOW TEMPERATURE

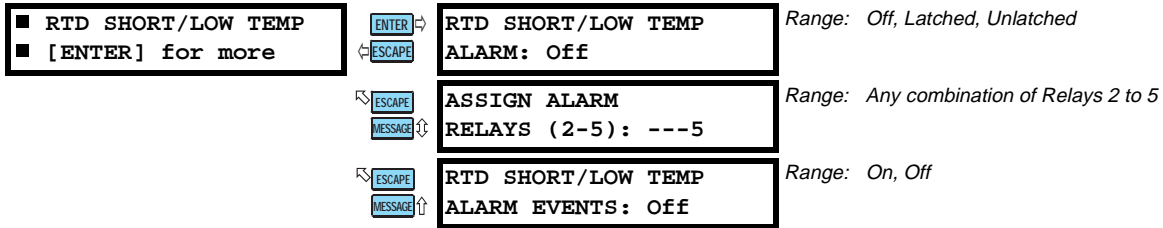

The 489 has an RTD Short/Low Temperature alarm. This alarm will look at all RTDs that have either an alarm or trip programmed and determine if an RTD has either a short or a very low temperature (less than -50°C). Any RTDs that do not have a trip or alarm associated with them will be ignored for this feature. When a short/low temperature is detected, the assigned output relay will operate and a message will appear on the display identifying the RTD that caused the alarm. It is recommended that if this feature is used, the alarm be programmed as latched so that intermittent RTDs are detected and corrective action may be taken.

4.10.1 489 THERMAL MODEL

The thermal model of the 489 is primarily intended for induction generators, especially those that start on the system bus in the same manner as induction motors. However, some of the thermal model features may be used to model the heating that occurs in synchronous generators during overload conditions.

One of the principle enemies of generator life is heat. Generator thermal limits are dictated by the design of both the stator and the rotor. Induction generators that start on the system bus have three modes of operation: locked rotor or stall (when the rotor is not turning), acceleration (when the rotor is coming up to speed), and generating (when the rotor turns at super-synchronous speed). Heating occurs in the generator during each of these conditions in very distinct ways. Typically, during the generator starting, locked rotor and acceleration conditions, the generator will be rotor limited. That is to say that the rotor will approach its thermal limit before the stator. Under locked rotor conditions, voltage is induced in the rotor at line frequency, 50 or 60 Hz. This voltage causes a current to flow in the rotor, also at line frequency, and the heat generated (I^2R) is a function of the effective rotor resistance. At 50 or 60 Hz, the reactance of the rotor cage causes the current to flow at the outer edges of the rotor bars. The effective resistance of the rotor is therefore at a maximum during a locked rotor condition as is rotor heating. When the generator is running at above rated speed, the voltage induced in the rotor is at a low frequency (approximately 1 Hz) and therefore, the effective resistance of the rotor is reduced quite dramatically. During overloads, the generator thermal limit is typically dictated by stator parameters. Some special generators might be all stator or all rotor limited. During acceleration, the dynamic nature of the generator slip dictates that rotor impedance is also dynamic, and a third thermal limit characteristic is necessary.

The figure below illustrates typical thermal limit curves for induction motors. The starting characteristic is shown for a high inertia load at 80% voltage. If the machine started quicker, the distinct characteristics of the thermal limit curves would not be required and the running overload curve would be joined with locked rotor safe stall times to produce a single overload curve.

The generator manufacturer should provide a safe stall time or thermal limit curves for any generator that is started as an induction motor. These thermal limits are intended to be used as guidelines and their definition is not always precise. When operation of the generator exceeds the thermal limit, the generator insulation does not immediately melt, rather, the rate of insulation degradation reaches a point where continued operation will significantly reduce generator life.

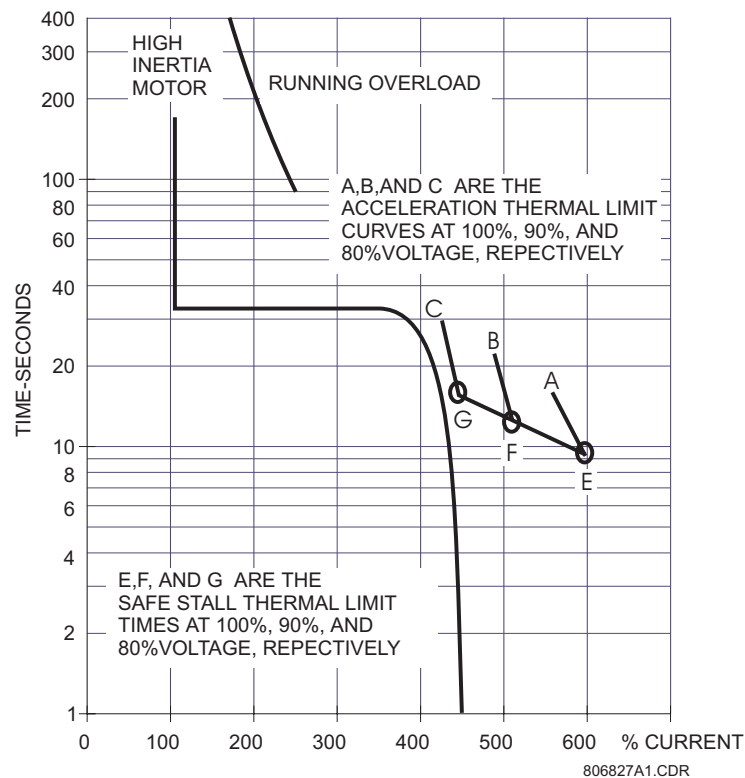

Figure 4–10: TYPICAL TIME-CURRENT AND THERMAL LIMIT CURVES (ANSI/IEEE C37.96)

4.10.2 MODEL SETUP

■ MODEL SETUP
 ■ [ENTER] for more

[ENTER]	ENABLE THERMAL	Range: No, Yes
[ESCAPE]	MODEL: No	
[ESCAPE]	OVERLOAD PICKUP	Range: 1.01 to 1.25 x FLA in steps of 0.01
[MESSAGE]	LEVEL: 1.01 x FLA	
[ESCAPE]	UNBALANCE BIAS	Range: 0 to 12 in steps of 1
[MESSAGE]	K FACTOR	A value of "0" effectively defeats this feature
[ESCAPE]	COOL TIME CONSTANT	Range: 0 to 500 min. in steps of 1
[MESSAGE]	ONLINE: 15 min.	
[ESCAPE]	COOL TIME CONSTANT	Range: 0 to 500 min. in steps of 1
[MESSAGE]	OFFLINE: 30 min.	
[ESCAPE]	HOT/COLD SAFE	Range: 0.01 to 1.00 in steps of 0.01
[MESSAGE]	STALL RATIO: 1.00	
[ESCAPE]	ENABLE RTD	Range: No, Yes
[MESSAGE]	BIASING: No	
[ESCAPE]	RTD BIAS	Range: 0 to 250°C in steps of 1
[MESSAGE]	MINIMUM: 40°C	Seen only if ENABLE RTD BIASING is set to Yes
[ESCAPE]	RTD BIAS CENTER	Range: 0 to 250°C in steps of 1
[MESSAGE]	POINT: 130°C	Seen only if ENABLE RTD BIASING is set to Yes
[ESCAPE]	RTD BIAS	Range: 0 to 250°C in steps of 1
[MESSAGE]	MAXIMUM: 155°C	Seen only if ENABLE RTD BIASING is set to Yes
[ESCAPE]	SELECT CURVE STYLE:	Range: Standard, Custom, Voltage Dependent
[MESSAGE]	Standard	
[ESCAPE]	STANDARD OVERLOAD	Range: 1 to 15 in steps of 1
[MESSAGE]	CURVE NUMBER: 4	Seen only if SELECT CURVE STYLE is Standard
[ESCAPE]	TIME TO TRIP AT	Range: 0.5 to 99999.9 in steps of 0.1
[MESSAGE]	1.01 x FLA: 17414.5 s	Seen only if SELECT CURVE STYLE is Standard
	↓	
[ESCAPE]	TIME TO TRIP AT	Range: 0.5 to 99999.9 in steps of 0.1
[MESSAGE]	20.0 x FLA: 20.0 x FLA	Seen only if SELECT CURVE STYLE is Standard
[ESCAPE]	MINIMUM ALLOWABLE	Range: 70 to 95% in steps of 1. Seen only if SELECT CURVE STYLE is Voltage Dependent
[MESSAGE]	VOLTAGE: 80%	
[ESCAPE]	STALL CURRENT @ MIN	Range: 2.00 to 15.00 x FLA in steps of 0.01. Seen only if SELECT CURVE STYLE is Voltage Dependent
[MESSAGE]	VOLTAGE: 4.80 x FLA	
[ESCAPE]	SAFE STALL TIME @	Range: 0.5 to 999.9 in steps of 0.1. Seen only if SELECT CURVE STYLE is Voltage Dependent
[MESSAGE]	MIN VOLTAGE: 20.0 s	
[ESCAPE]	ACCEL. INTERSECT @	Range: 2.00 to STALL CURRENT @ MIN VOLTAGE in steps of 0.01. Seen only if SELECT CURVE STYLE is Voltage Dependent
[MESSAGE]	MIN VOLT: 3.80 x FLA	
[ESCAPE]	STALL CURRENT @ 100%	Range: 2.00 to 15.00 x FLA in steps of 0.01. Seen only if SELECT CURVE STYLE is Voltage Dependent
[MESSAGE]	VOLTAGE: 6.00 x FLA	
[ESCAPE]	SAFE STALL TIME @	Range: 0.5 to 999.9 in steps of 0.1. Seen only if SELECT CURVE STYLE is Voltage Dependent
[MESSAGE]	100% VOLTAGE: 10.0 s	
[ESCAPE]	ACCEL. INTERSECT @	Range: 2.00 to STALL CURRENT @ 100% VOLTAGE in steps of 0.01. Seen only if SELECT CURVE STYLE is Voltage Dependent
[MESSAGE]	100% VOLT: 5.00 x FLA	

The current measured at the output CTs is used for the thermal model. The thermal model consists of five key elements: the overload curve and overload pickup level, the unbalance biasing of the generator current while the machine is running, the cooling time constants, and the biasing of the thermal model based on hot/cold generator information and measured stator temperature. Each of these elements are described in detail in the sections that follow.



The generator FLA is calculated as:
$$\frac{\text{Generator Rated MVA}}{\sqrt{3} \times \text{Rated Generator Phase-Phase Voltage}}$$

The 489 integrates both stator and rotor heating into one model. Machine heating is reflected in a register called Thermal Capacity Used. If the machine has been stopped for a long period of time, it will be at ambient temperature and thermal capacity used should be zero. If the machine is in overload, once the thermal capacity used reaches 100%, a trip will occur.

The overload curve accounts for machine heating during stall, acceleration, and running in both the stator and the rotor. The Overload Pickup setpoint defines where the running overload curve begins as the generator enters an overload condition. This is useful to accommodate a service factor. The curve is effectively cut off at current values below this pickup.

Generator thermal limits consist of three distinct parts based on the three conditions of operation, locked rotor or stall, acceleration, and running overload. Each of these curves may be provided for both a hot and cold machine. A hot machine is defined as one that has been running for a period of time at full load such that the stator and rotor temperatures have settled at their rated temperature. A cold machine is defined as a machine that has been stopped for a period of time such that the stator and rotor temperatures have settled at ambient temperature. For most machines, the distinct characteristics of the thermal limits are formed into one smooth homogeneous curve. Sometimes only a safe stall time is provided. This is acceptable if the machine has been designed conservatively and can easily perform its required duty without infringing on the thermal limit. In this case, the protection can be conservative. If the machine has been designed very close to its thermal limits when operated as required, then the distinct characteristics of the thermal limits become important.

The 489 overload curve can take one of three formats, Standard, Custom Curve, or Voltage Dependent. Regardless of which curve style is selected, the 489 will retain thermal memory in the form of a register called Thermal Capacity Used. This register is updated every 50 ms using the following equation:

$$TC_{\text{used } t} = TC_{\text{used } t-50\text{ms}} + \frac{50 \text{ ms}}{\text{time to trip}} \times 100\%$$

where: time to trip = time taken from the overload curve at I_{leq} as a function of FLA.

The overload protection curve should always be set slightly lower than the thermal limits provided by the manufacturer. This will ensure that the machine is tripped before the thermal limit is reached. If the starting times are well within the safe stall times, it is recommended that the 489 Standard Overload Curve be used. The standard overload curves are a series of 15 curves with a common curve shape based on typical generator thermal limit curves (see the following figure and table).

When the generator trips offline due to overload the generator will be locked out (the trip relay will stay latched) until generator thermal capacity reaches below 15%.

4

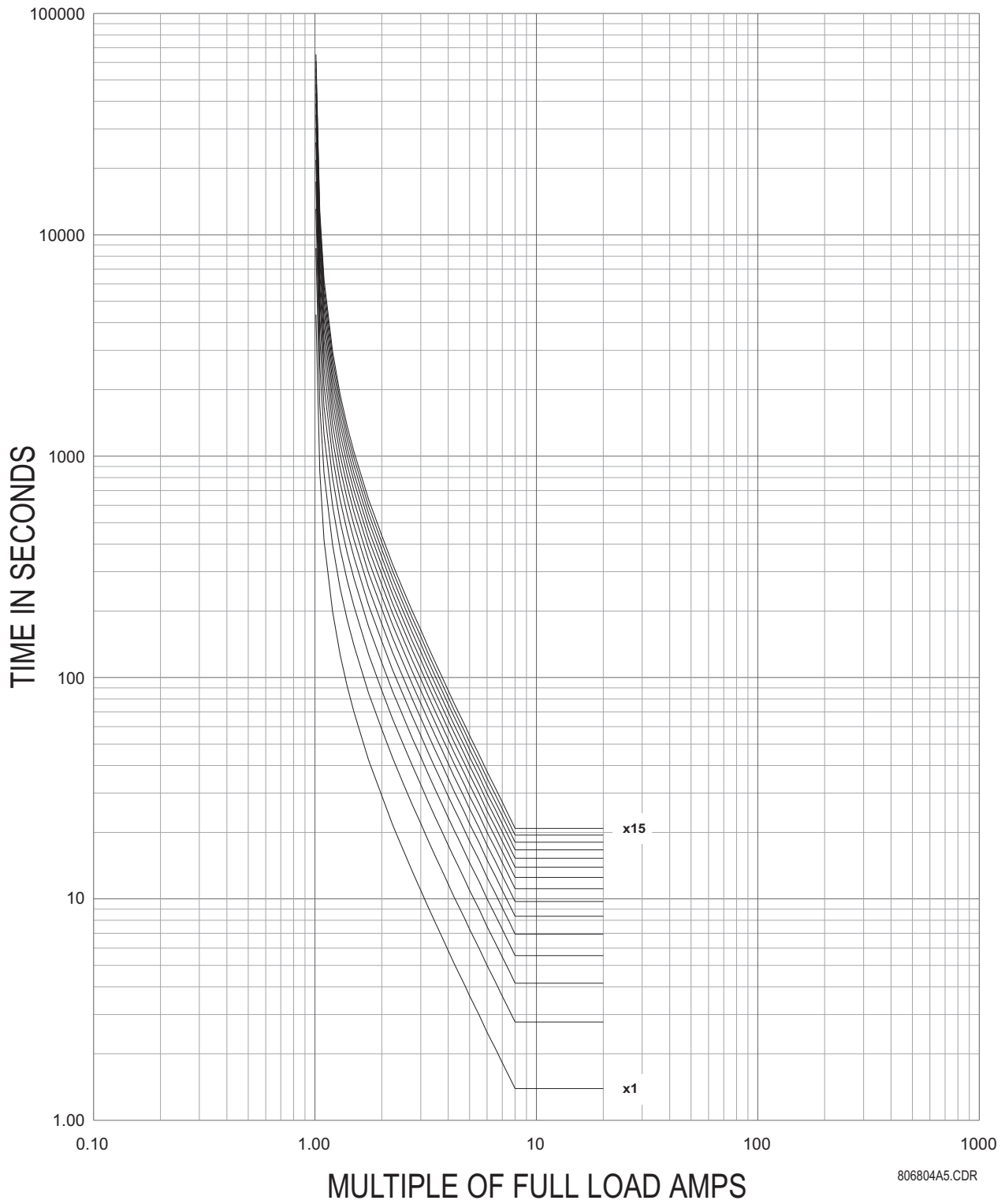

Figure 4-11: 489 STANDARD OVERLOAD CURVES

Table 4-7: 489 STANDARD OVERLOAD CURVE MULTIPLIERS

PICKUP LEVEL	STANDARD CURVE MULTIPLIERS														
	× 1	× 2	× 3	× 4	× 5	× 6	× 7	× 8	× 9	× 10	× 11	× 12	× 13	× 14	× 15
1.01	4353.6	8707.2	13061	17414	21768	26122	30475	34829	39183	43536	47890	52243	56597	60951	65304
1.05	853.71	1707.4	2561.1	3414.9	4268.6	5122.3	5976.0	6829.7	7683.4	8537.1	9390.8	10245	11098	11952	12806
1.10	416.68	833.36	1250.0	1666.7	2083.4	2500.1	2916.8	3333.5	3750.1	4166.8	4583.5	5000.2	5416.9	5833.6	6250.2
1.20	198.86	397.72	596.58	795.44	994.30	1193.2	1392.0	1590.9	1789.7	1988.6	2187.5	2386.3	2585.2	2784.1	2982.9
1.30	126.80	253.61	380.41	507.22	634.02	760.82	887.63	1014.4	1141.2	1268.0	1394.8	1521.6	1648.5	1775.3	1902.1
1.40	91.14	182.27	273.41	364.55	455.68	546.82	637.96	729.09	820.23	911.37	1002.5	1093.6	1184.8	1275.9	1367.0
1.50	69.99	139.98	209.97	279.96	349.95	419.94	489.93	559.92	629.91	699.90	769.89	839.88	909.87	979.86	1049.9
1.75	42.41	84.83	127.24	169.66	212.07	254.49	296.90	339.32	381.73	424.15	466.56	508.98	551.39	593.81	636.22
2.00	29.16	58.32	87.47	116.63	145.79	174.95	204.11	233.26	262.42	291.58	320.74	349.90	379.05	408.21	437.37
2.25	21.53	43.06	64.59	86.12	107.65	129.18	150.72	172.25	193.78	215.31	236.84	258.37	279.90	301.43	322.96
2.50	16.66	33.32	49.98	66.64	83.30	99.96	116.62	133.28	149.94	166.60	183.26	199.92	216.58	233.24	249.90
2.75	13.33	26.65	39.98	53.31	66.64	79.96	93.29	106.62	119.95	133.27	146.60	159.93	173.25	186.58	199.91
3.00	10.93	21.86	32.80	43.73	54.66	65.59	76.52	87.46	98.39	109.32	120.25	131.19	142.12	153.05	163.98
3.25	9.15	18.29	27.44	36.58	45.73	54.87	64.02	73.16	82.31	91.46	100.60	109.75	118.89	128.04	137.18
3.50	7.77	15.55	23.32	31.09	38.87	46.64	54.41	62.19	69.96	77.73	85.51	93.28	101.05	108.83	116.60
3.75	6.69	13.39	20.08	26.78	33.47	40.17	46.86	53.56	60.25	66.95	73.64	80.34	87.03	93.73	100.42
4.00	5.83	11.66	17.49	23.32	29.15	34.98	40.81	46.64	52.47	58.30	64.13	69.96	75.79	81.62	87.45
4.25	5.12	10.25	15.37	20.50	25.62	30.75	35.87	41.00	46.12	51.25	56.37	61.50	66.62	71.75	76.87
4.50	4.54	9.08	13.63	18.17	22.71	27.25	31.80	36.34	40.88	45.42	49.97	54.51	59.05	63.59	68.14
4.75	4.06	8.11	12.17	16.22	20.28	24.33	28.39	32.44	36.50	40.55	44.61	48.66	52.72	56.77	60.83
5.00	3.64	7.29	10.93	14.57	18.22	21.86	25.50	29.15	32.79	36.43	40.08	43.72	47.36	51.01	54.65
5.50	2.99	5.98	8.97	11.96	14.95	17.94	20.93	23.91	26.90	29.89	32.88	35.87	38.86	41.85	44.84
6.00	2.50	5.00	7.49	9.99	12.49	14.99	17.49	19.99	22.48	24.98	27.48	29.98	32.48	34.97	37.47
6.50	2.12	4.24	6.36	8.48	10.60	12.72	14.84	16.96	19.08	21.20	23.32	25.44	27.55	29.67	31.79
7.00	1.82	3.64	5.46	7.29	9.11	10.93	12.75	14.57	16.39	18.21	20.04	21.86	23.68	25.50	27.32
7.50	1.58	3.16	4.75	6.33	7.91	9.49	11.08	12.66	14.24	15.82	17.41	18.99	20.57	22.15	23.74
8.00	1.39	2.78	4.16	5.55	6.94	8.33	9.71	11.10	12.49	13.88	15.27	16.65	18.04	19.43	20.82
10.00	1.39	2.78	4.16	5.55	6.94	8.33	9.71	11.10	12.49	13.88	15.27	16.65	18.04	19.43	20.82
15.00	1.39	2.78	4.16	5.55	6.94	8.33	9.71	11.10	12.49	13.88	15.27	16.65	18.04	19.43	20.82
20.00	1.39	2.78	4.16	5.55	6.94	8.33	9.71	11.10	12.49	13.88	15.27	16.65	18.04	19.43	20.82



Above 8.0 × Pickup, the trip time for 8.0 is used. This prevents the overload curve from acting as an instantaneous element.

The standard overload curves equation is:

$$\text{Time to Trip} = \frac{\text{Curve Multiplier} \times 2.2116623}{0.02530337 \times (\text{Pickup} - 1)^2 + 0.05054758 \times (\text{Pickup} - 1)}$$

a) CUSTOM OVERLOAD CURVE

If the induction generator starting current begins to infringe on the thermal damage curves, it may become necessary to use a custom curve to tailor generator protection so successful starting may be possible without compromising protection. Furthermore, the characteristics of the starting thermal (locked rotor and acceleration) and the running thermal damage curves may not fit together very smoothly. In this instance, it may be necessary to use a custom curve to tailor protection to the thermal limits to allow the generator to be started successfully and utilized to its full potential without compromising protection. The distinct parts of the thermal limit curves now become more critical. For these conditions, it is recommended that the 489 custom curve thermal model be used. The custom overload curve allows users to program their own curves by entering trip times for 30 pre-determined current levels.

The curves below show that if the running overload thermal limit curve were smoothed into one curve with the locked rotor thermal limit curve, the induction generator could not be started at 80% voltage. A custom curve is required.

4

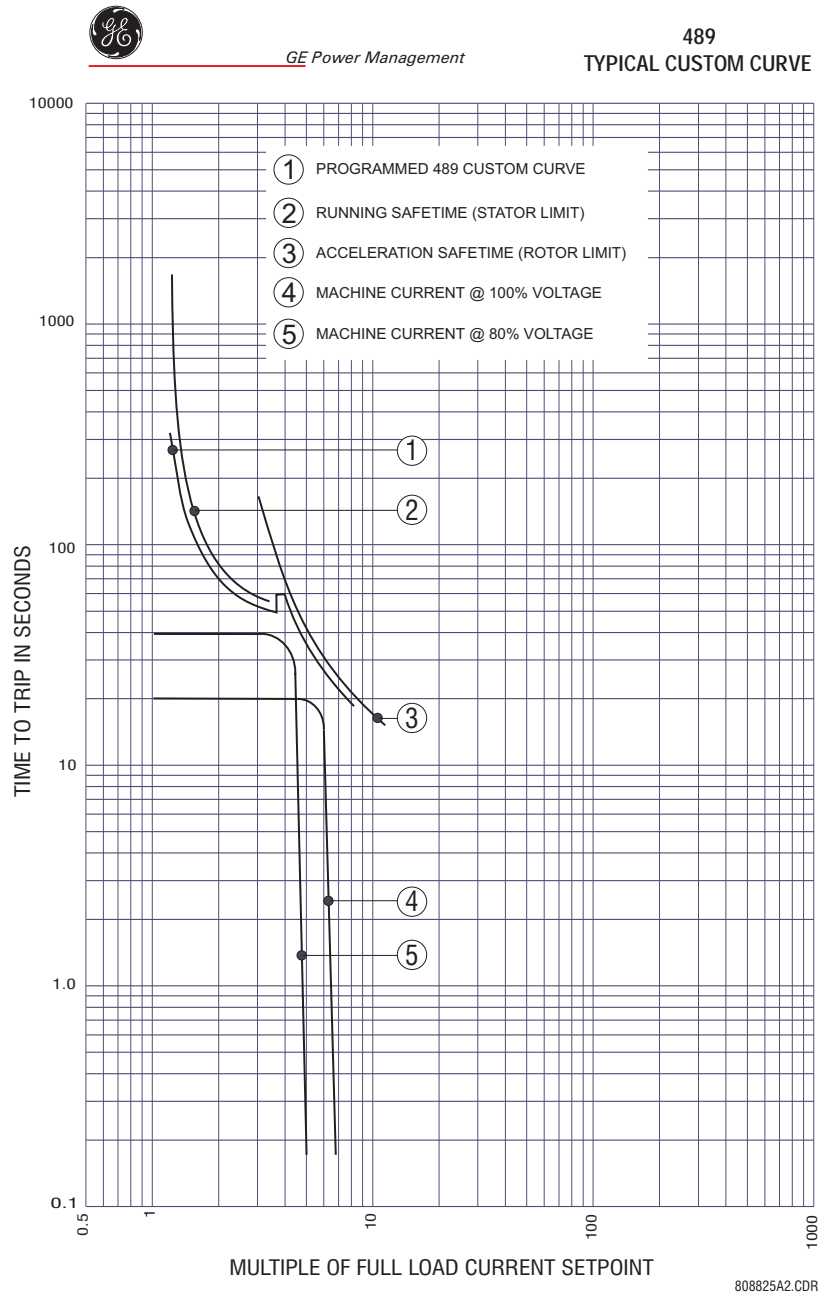

Figure 4-12: CUSTOM CURVE EXAMPLE

b) VOLTAGE DEPENDENT OVERLOAD CURVE

It is possible and acceptable that the acceleration time exceeds the safe stall time (bearing in mind that a locked rotor condition is quite different than an acceleration condition). In this instance, each distinct portion of the thermal limit curve must be known and protection coordinated against that curve. The protection relay must be able to distinguish between a locked rotor condition, an accelerating condition, and a running condition. The 489 voltage dependent overload curve feature is tailored to protect these types of machines. Voltage is monitored constantly during starting and the acceleration thermal limit curve adjusted accordingly. If the VT Connection setpoint is set to none or if a VT fuse failure is detected, the acceleration thermal limit curve for the minimum allowable voltage will be used.

The voltage dependent overload curve is comprised of the three characteristic thermal limit curve shapes determined by the stall or locked rotor condition, acceleration, and running overload. The curve is constructed by entering a custom curve shape for the running overload protection curve. Next, a point must be entered for the acceleration protection curve at the point of intersection with the custom curve, based on the minimum allowable starting voltage as defined by the minimum allowable voltage. Locked Rotor Current and safe stall time must also be entered for that voltage. A second point of intersection must be entered for 100% voltage. Once again, the locked rotor current and the safe stall time must be entered, this time for 100% voltage. The protection curve that is created from the safe stall time and intersection point will be dynamic based on the measured voltage between the minimum allowable voltage and the 100% voltage. This method of protection inherently accounts for the change in speed as an impedance relay would. The change in impedance is reflected by machine terminal voltage and line current. For any given speed at any given voltage, there is only one value of line current.

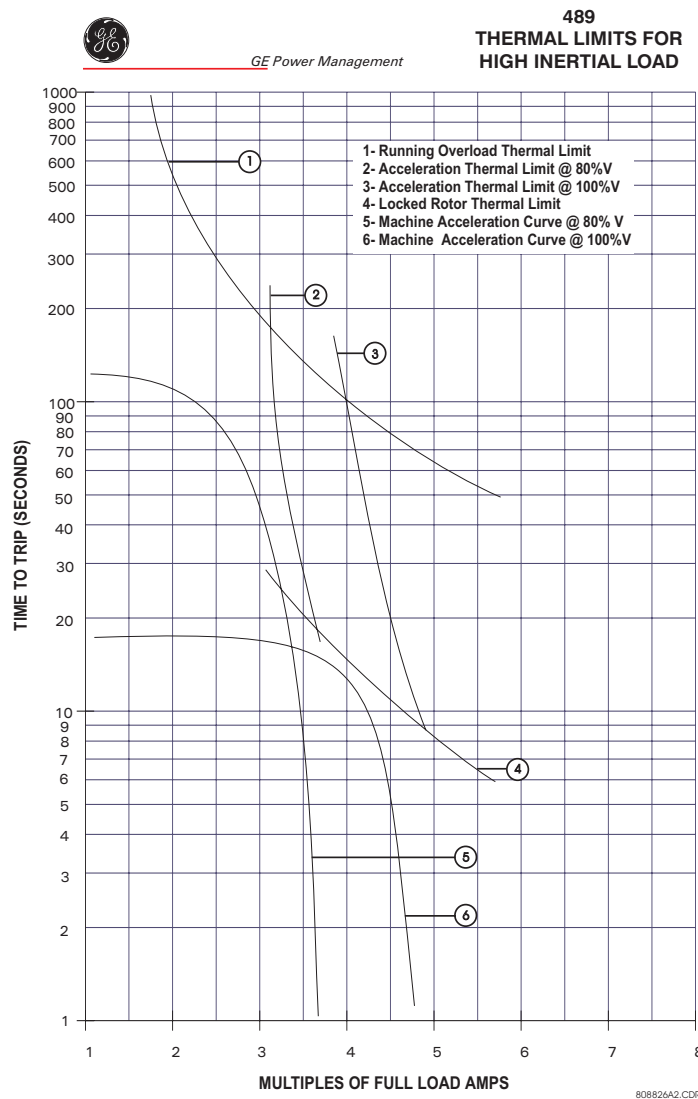

Figure 4-13: THERMAL LIMITS FOR HIGH INERTIAL LOAD

To illustrate the Voltage Dependent Overload Curve feature, the thermal limits shown in Figure 4–13: THERMAL LIMITS FOR HIGH INERTIAL LOAD on page 4–57 will be used.

1. Construct a custom curve for the running overload thermal limit. If the curve does not extend to the acceleration thermal limits, extend it such that the curve intersects the acceleration thermal limit curves. (see CUSTOM CURVE below).
2. Enter the per unit current value for the acceleration overload curve intersect with the custom curve for 80% voltage. Also enter the per unit current and safe stall protection time for 80% voltage (see ACCELERATION CURVE below).
3. Enter the per unit current value for the acceleration overload curve intersect with the custom curve for 100% voltage. Also enter the per unit current and safe stall protection time for 100% voltage (see ACCELERATION CURVE below)

4

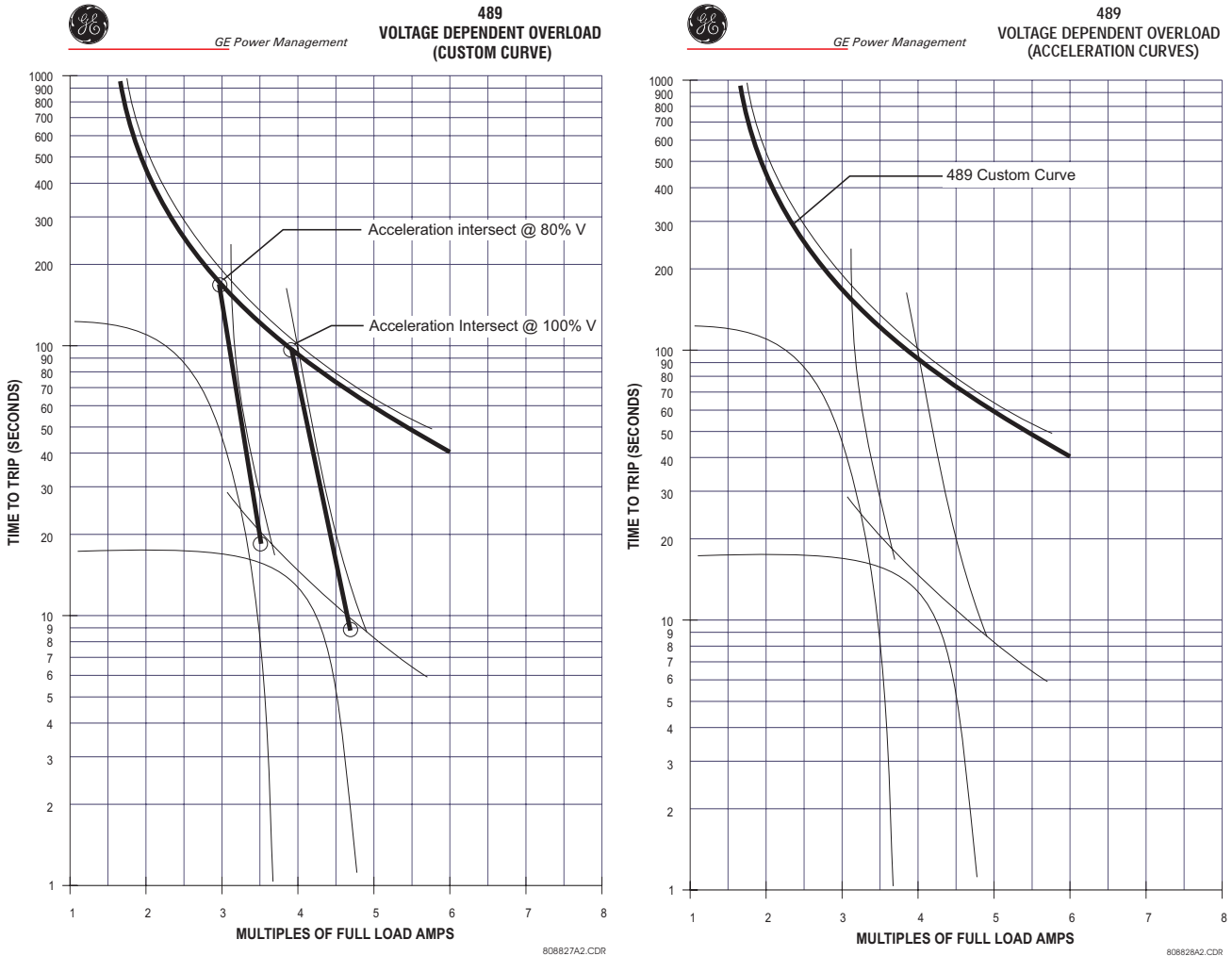
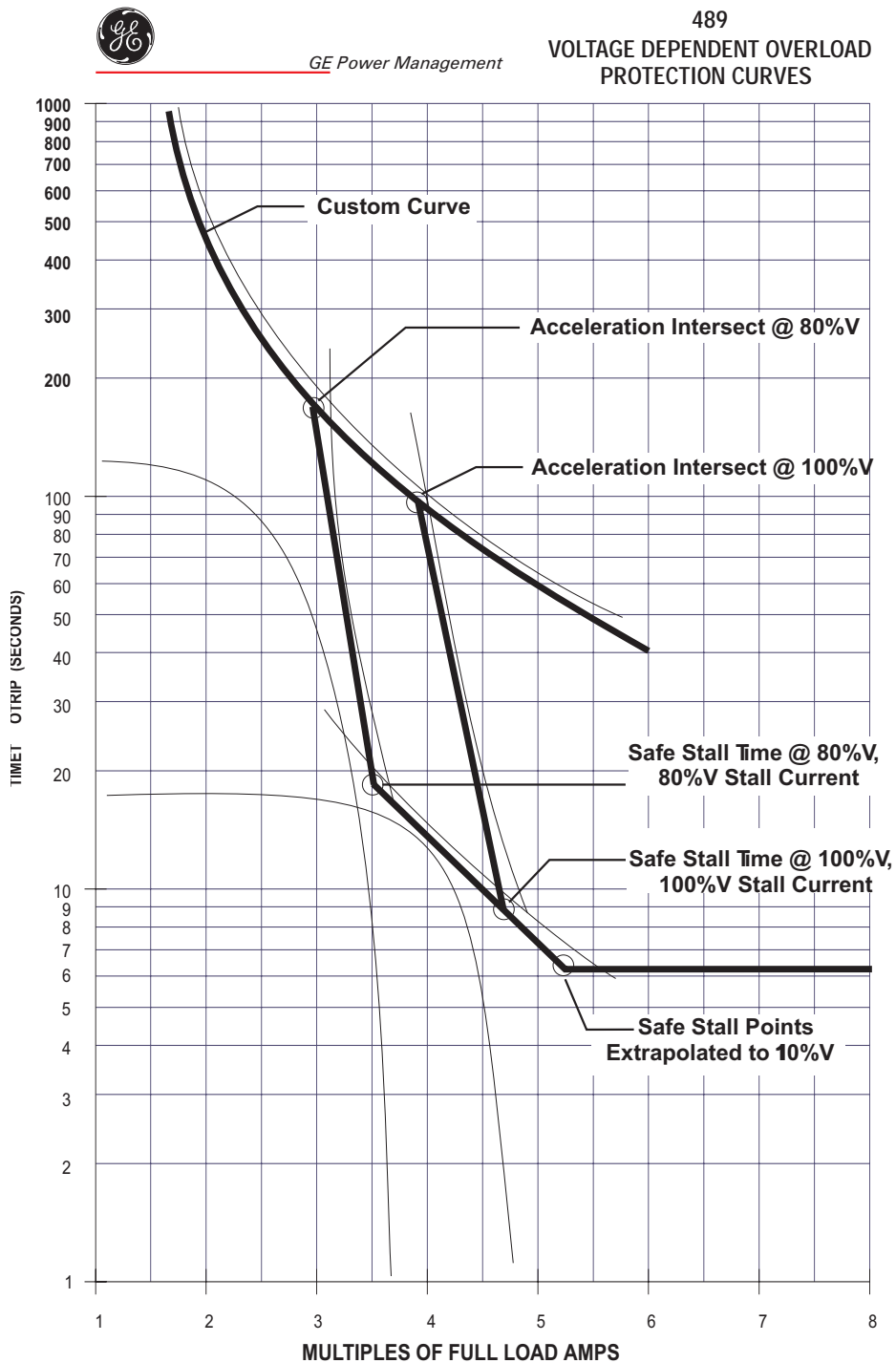

Figure 4–14: VOLTAGE DEPENDENT OVERLOAD CURVES

The 489 takes the information provided and create protection curves for any voltage between the minimum and 100%. For values above the voltage in question, the 489 extrapolates the safe stall protection curve to 110% voltage. This current level is calculated by taking the locked rotor current at 100% voltage and multiplying by 1.10. For trip times above the 110% current level, the trip time of 110% will be used (see the figure below).



808831A2.CDR

Figure 4-15: VOLTAGE DEPENDENT OVERLOAD PROTECTION CURVES



The safe stall curve is in reality a series of safe stall points for different voltages. For a given voltage, there can be only one value of stall current, and therefore only one safe stall time.

The following curves illustrate the resultant overload protection for 80% and 100% voltage, respectively. For voltages in-between these levels, the 489 shifts the acceleration curve linearly and constantly based upon the measured voltage during generator start.

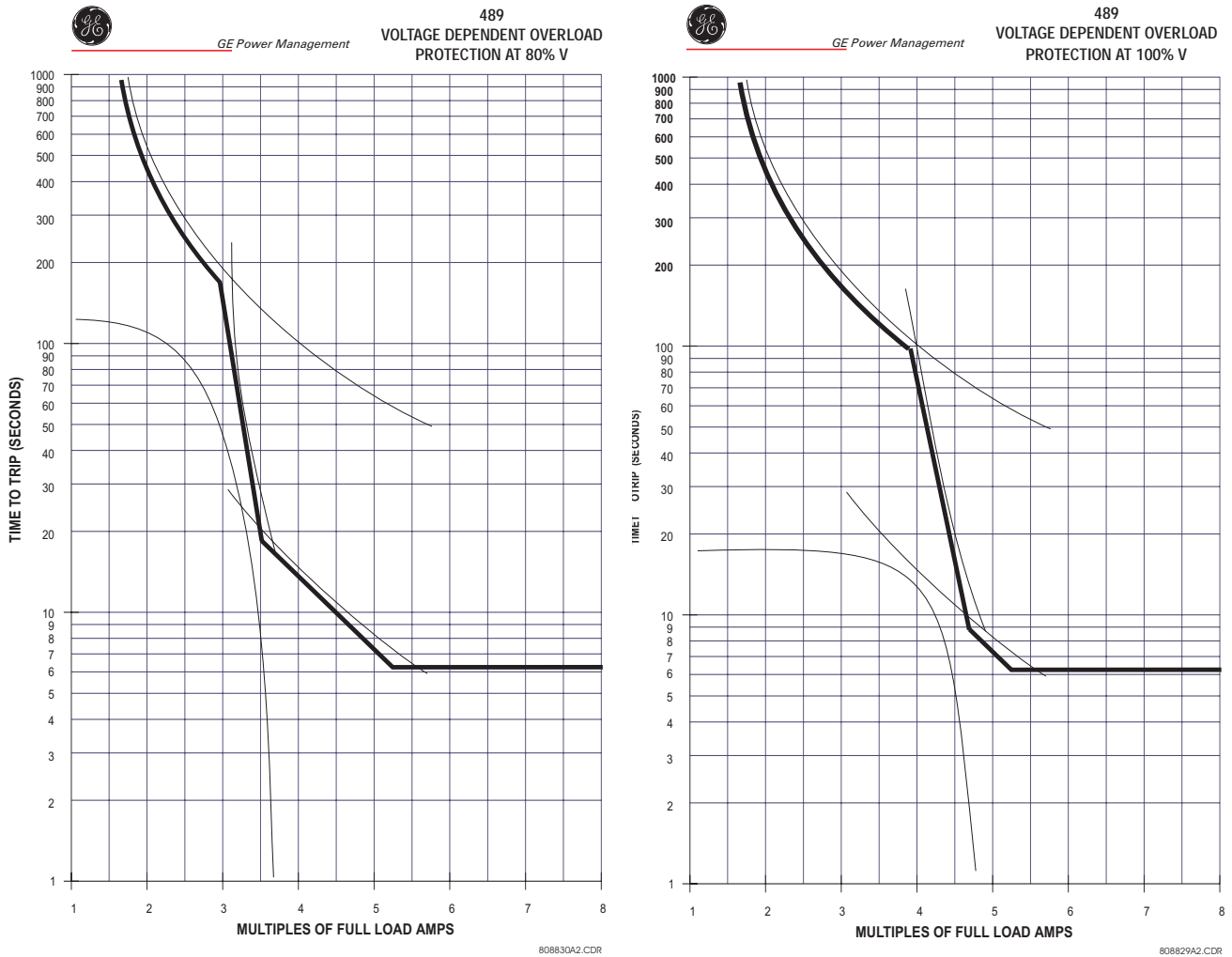

Figure 4-16: VOLTAGE DEPENDENT O/L PROTECTION AT 80% AND 100% VOLTAGE

4

4.10.3 UNBALANCE BIAS

Unbalanced phase currents will cause additional rotor heating that will not be accounted for by electromechanical relays and may not be accounted for in some electronic protective relays. When the generator is running, the rotor will rotate in the direction of the positive sequence current at near synchronous speed. Negative sequence current, which has a phase rotation that is opposite to the positive sequence current, and hence, opposite to the rotor rotation, will generate a rotor voltage that will produce a substantial rotor current. This induced current will have a frequency that is approximately twice the line frequency, 100 Hz for a 50 Hz system or 120 Hz for a 60 Hz system. Skin effect in the rotor bars at this frequency will cause a significant increase in rotor resistance and therefore, a significant increase in rotor heating. This extra heating is not accounted for in the thermal limit curves supplied by the generator manufacturer as these curves assume positive sequence currents only that come from a perfectly balanced supply and generator design.

The 489 measures the ratio of negative to positive sequence current. The thermal model may be biased to reflect the additional heating that is caused by negative sequence current when the machine is running. This biasing is done by creating an equivalent heating current rather than simply using average current ($I_{\text{per_unit}}$). This equivalent current is calculated using the equation shown below.

$$I_{eq} = \sqrt{I_1^2 + kI_2^2}$$

where: I_{eq} = equivalent motor heating current in per unit (based on FLA)

I_2 = negative-sequence current in per unit (based on FLA)

I_1 = positive-sequence current in per unit (based on FLA)

k = constant relating negative-sequence rotor resistance to positive-sequence rotor resistance, not to be confused with the k indicating generator negative-sequence capability for an inverse time curve.

The figure below shows induction machine derating as a function of voltage unbalance as recommended by NEMA (National Electrical Manufacturers Association). Assuming a typical inrush of $6 \times \text{FLA}$ and a negative sequence impedance of 0.167, voltage unbalances of 1, 2, 3, 4, and 5% equal current unbalances of 6, 12, 18, 24, and 30%, respectively. Based on this assumption, the GE curve illustrates the amount of machine derating for different values of k entered for the **UNBALANCE BIAS K FACTOR** setpoint. Note that the curve created when $k = 8$ is almost identical to the NEMA derating curve.

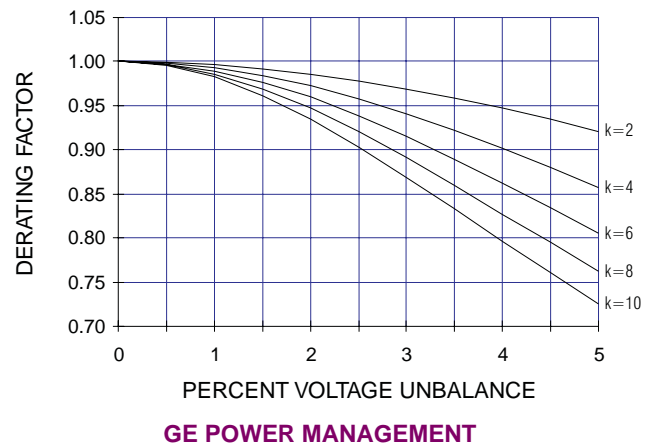
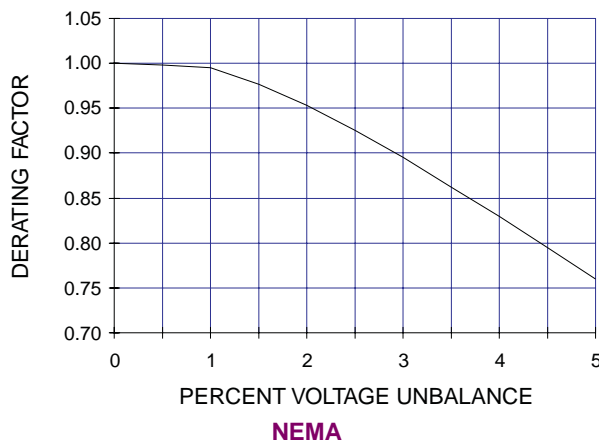

If a k value of 0 is entered, the unbalance biasing is defeated and the overload curve will time out against the measured per unit motor current. k may be calculated conservatively as:

$$k = \frac{175}{I_{LR}^2} \text{ (typical estimate); } k = \frac{230}{I_{LR}^2} \text{ (conservative estimate), where } I_{LR} \text{ is the per unit locked rotor current}$$

4.10.4 MACHINE COOLING

The 489 thermal capacity used value is reduced exponentially when the motor current is below the **OVERLOAD PICKUP** setpoint. This reduction simulates machine cooling. The cooling time constants should be entered for both stopped and running cases (the generator is assumed to be running if current is measured or the generator is offline). A machine with a stopped rotor normally cools significantly slower than one with a turning rotor. Machine cooling is calculated using the following formulae:

$$TC_{used} = (TC_{used_start} - TC_{used_end})(e^{-t/\tau}) + TC_{used_end}$$

$$TC_{used_end} = \left(\frac{I_{eq}}{overload_pickup}\right)\left(1 - \frac{hot}{cold}\right) \times 100\%$$

- where:
- TC_{used} = thermal capacity used
 - TC_{used_start} = TC_{used} value caused by overload condition
 - TC_{used_end} = TC_{used} value dictated by the hot/cold curve ratio when the machine is running (= 0 when the machine is stopped)
 - t = time in minutes
 - τ = Cool Time Constant (running or stopped)
 - I_{eq} = equivalent heating current
 - overload_pickup = overload pickup setpoint as a multiple of FLA
 - hot / cold = hot/cold curve ratio

4

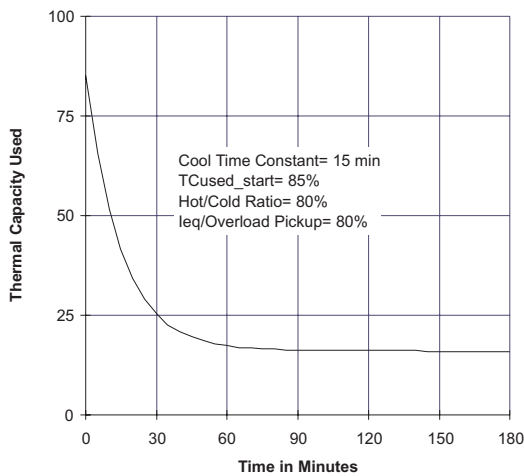

Thermal Model Cooling, 80% Load

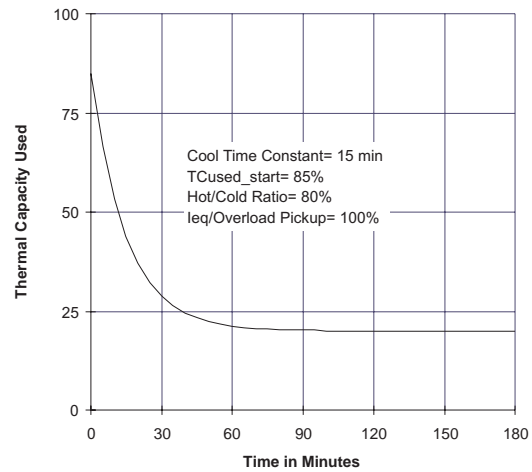

Thermal Model Cooling, 100% Load

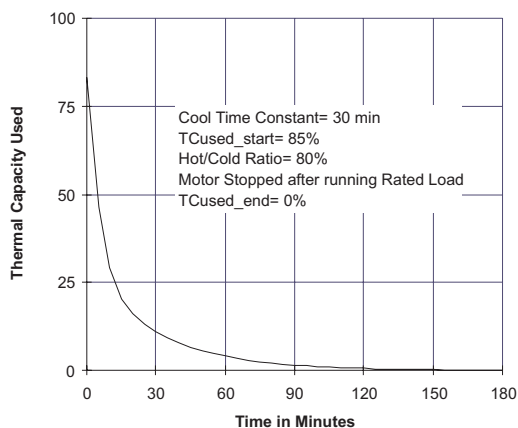

Thermal Model Cooling, Motor Stopped

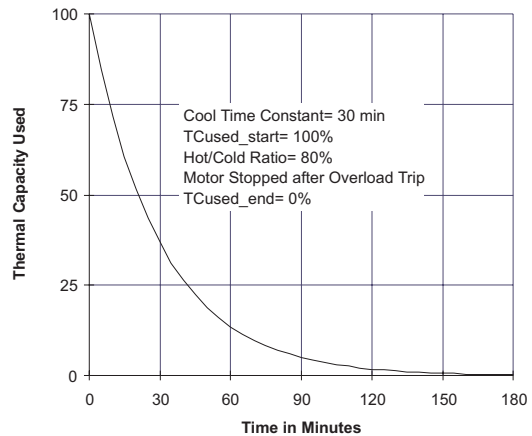

Thermal Model Cooling, Motor Tripped

Figure 4-17: THERMAL MODEL COOLING

4.10.5 HOT/COLD CURVE RATIO

When thermal limit information is available for both a hot and cold machine, the 489 thermal model will adapt for the conditions if the **HOT/COLD CURVE RATIO** is programmed. The value entered for this setpoint dictates the level of thermal capacity used that the relay will settle at for levels of current that are below the **OVERLOAD PICKUP LEVEL**. When the generator is running at a level below the **OVERLOAD PICKUP LEVEL**, the thermal capacity used will rise or fall to a value based on the average phase current and the entered **HOT/COLD CURVE RATIO**. Thermal capacity used will either rise at a fixed rate of 5% per minute or fall as dictated by the running cool time constant.

$$TC_{\text{used_end}} = I_{eq} \times \left(1 - \frac{\text{hot}}{\text{cold}}\right) \times 100\%$$

where: $TC_{\text{used_end}}$ = Thermal Capacity Used if I_{per_unit} remains steady state
 I_{eq} = equivalent generator heating current
 hot/cold = **HOT/COLD CURVE RATIO** setpoint

The hot/cold curve ratio may be determined from the thermal limit curves, if provided, or the hot and cold safe stall times. Simply divide the hot safe stall time by the cold safe stall time. If hot and cold times are not provided, there can be no differentiation and the **HOT/COLD CURVE RATIO** should be entered as "1.00".

4.10.6 RTD BIAS

The thermal replica created by the features described in the sections above operates as a complete and independent model. However, the thermal overload curves are based solely on measured current, assuming a normal 40°C ambient and normal machine cooling. If there is an unusually high ambient temperature, or if machine cooling is blocked, generator temperature will increase. If the stator has embedded RTDs, the 489 RTD bias feature should be used to correct the thermal model.

The RTD bias feature is a two part curve, constructed using 3 points. If the maximum stator RTD temperature is below the **RTD BIAS MINIMUM** setpoint (typically 40°C), no biasing occurs. If the maximum stator RTD temperature is above the **RTD BIAS MAXIMUM** setpoint (typically at the stator insulation rating or slightly higher), then the thermal memory is fully biased and thermal capacity is forced to 100% used. At values in between, the present thermal capacity used created by the overload curve and other elements of the thermal model, is compared to the RTD Bias thermal capacity used from the RTD Bias curve. If the RTD Bias thermal capacity used value is higher, then that value is used from that point onward. The **RTD BIAS CENTER POINT** should be set at the rated running temperature of the machine. The 489 automatically determines the thermal capacity used value for the center point using the **HOT/COLD SAFE STALL RATIO** setpoint.

$$TC_{\text{used @ RTD_Bias_Center}} = \left(1 - \frac{\text{hot}}{\text{cold}}\right) \times 100\%$$

At temperatures less than the RTD_Bias_Center temperature,

$$RTD_Bias_TC_{\text{used}} = \frac{\text{Temp}_{\text{actual}} - \text{Temp}_{\text{min}}}{\text{Temp}_{\text{center}} - \text{Temp}_{\text{min}}} \times (100 - TC_{\text{used @ RTD_Bias_Center}}) + TC_{\text{used @ RTD_Bias_Center}}$$

At temperatures greater than the RTD_Bias_Center temperature,

$$RTD_Bias_TC_{\text{used}} = \frac{\text{Temp}_{\text{actual}} - \text{Temp}_{\text{center}}}{\text{Temp}_{\text{max}} - \text{Temp}_{\text{center}}} \times (100 - TC_{\text{used @ RTD_Bias_Center}}) + TC_{\text{used @ RTD_Bias_Center}}$$

where: $RTD_Bias_TC_{\text{used}}$ = TC used due to hottest stator RTD
 $\text{Temp}_{\text{actual}}$ = current temperature of the hottest stator RTD
 Temp_{min} = RTD Bias minimum setpoint
 $\text{Temp}_{\text{center}}$ = RTD Bias center setpoint
 Temp_{max} = RTD Bias maximum setpoint
 $TC_{\text{used @ RTD_Bias_Center}}$ = TC used defined by the **HOT/COLD SAFE STALL RATIO** setpoint

In simple terms, the RTD bias feature is real feedback of measured stator temperature. This feedback acts as correction of the thermal model for unforeseen situations. Since RTDs are relatively slow to respond, RTD biasing is good for correction and slow generator heating. The rest of the thermal model is required during high phase current conditions when machine heating is relatively fast.

It should be noted that the RTD bias feature alone cannot create a trip. If the RTD bias feature forces the thermal capacity used to 100%, the machine current must be above the over-load pickup before an overload trip occurs. Presumably, the machine would trip on stator RTD temperature at that time.

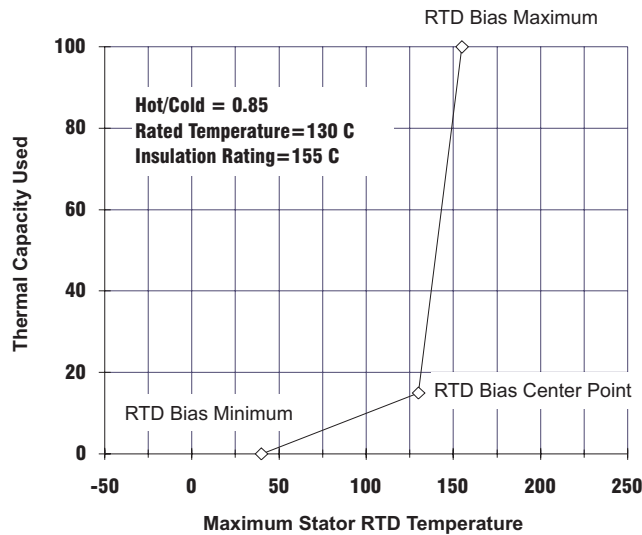

Figure 4-18: RTD BIAS CURVE

4.10.7 THERMAL ELEMENTS

<ul style="list-style-type: none"> ■ THERMAL ELEMENTS ■ [ENTER] for more 	[ENTER]	THERMAL MODEL ALARM: Off	Range: Off, Latched, Unlatched
	[ESCAPE]	ASSIGN ALARM RELAYS (2-5): ---5	Range: Any combination of Relays 2 to 5
	[ESCAPE] [MESSAGE]	THERMAL ALARM LEVEL: 75% Used	Range: 10 to 100% Used in steps of 1
	[ESCAPE] [MESSAGE]	THERMAL MODEL ALARM EVENTS: Off	Range: On, Off
	[ESCAPE] [MESSAGE]	THERMAL MODEL TRIP: Off	Range: Off, Latched, Unlatched
	[ESCAPE] [MESSAGE]	ASSIGN TRIP RELAYS (1-4): 1---	Range: Any combination of Relays 1 to 4

Once the thermal model is setup, an alarm and/or trip element can be enabled. If the generator has been offline for a long period of time, it will be at ambient temperature and thermal capacity used should be zero. If the generator is in overload, once the thermal capacity used reaches 100%, a trip will occur. The thermal model trip will remain active until a lockout time has expired. The lockout time will be based on the reduction of thermal capacity from 100% used to 15% used. This reduction will occur at a rate defined by the stopped cooling time constant. The thermal capacity used alarm may be used as a warning indication of an impending overload trip.

4.11.1 TRIP COUNTER

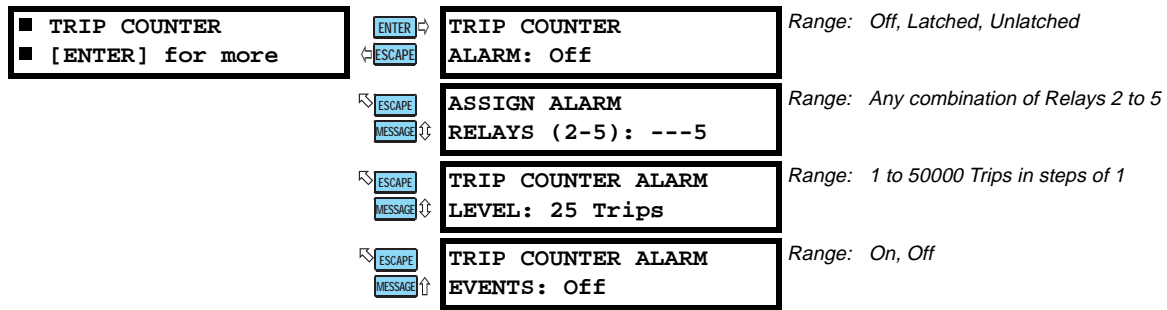

When enabled, a trip counter alarm will occur when the TRIP COUNTER ALARM LEVEL is reached. The trip counter must be cleared or the alarm level raised and the reset key must be pressed (if the alarm was latched) to reset the alarm.

For example, it might be useful to set a Trip Counter alarm at 100 trips, prompting the operator or supervisor to investigate the type of trips that have occurred. A breakdown of trips by type may be found in the **A4 MAINTENANCE \ TRIP COUNTERS** actual values page. If a trend is detected, it would warrant further investigation.

4.11.2 BREAKER FAILURE

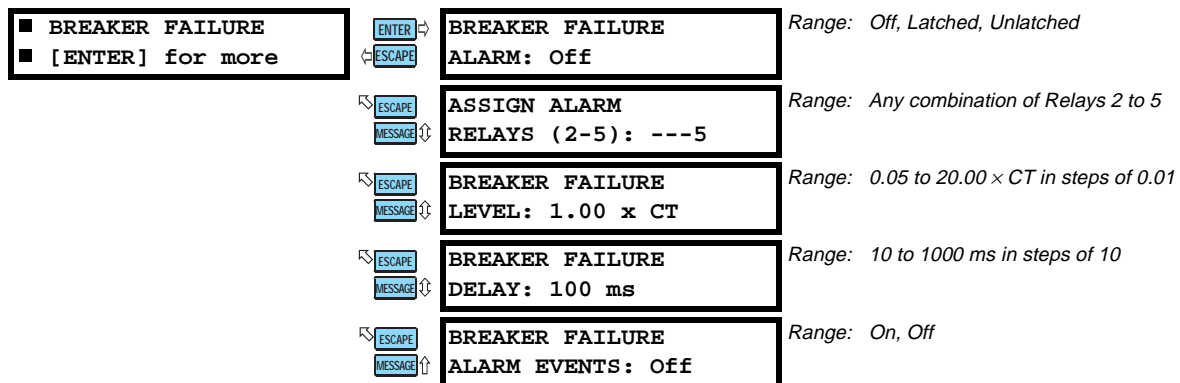

If the breaker failure alarm feature may be enabled as latched or unlatched. If the R1 Trip output relay is operated and the generator current measured at any of the three output CTs is above the level programmed for the period of time specified by the delay, a breaker failure alarm will occur. The time delay should be slightly longer than the breaker clearing time.

4.11.3 TRIP COIL MONITOR

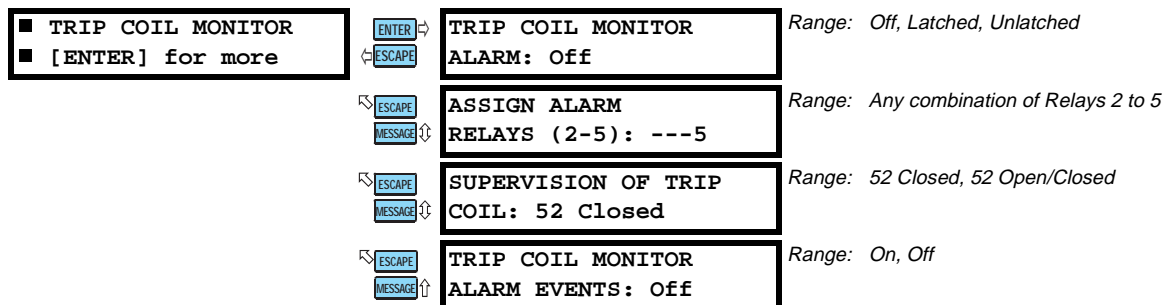

If the trip coil monitor alarm feature is enabled as latched or unlatched, the trip coil supervision circuitry will monitor the trip coil circuit for continuity any time that the breaker status input indicates that the breaker is closed. If that continuity is broken, a trip coil monitor alarm will occur in approximately 300 ms.

If 52 Open/Closed is selected, the trip coil supervision circuitry monitors the trip coil circuit for continuity at all times regardless of breaker state. This requires an alternate path around the 52a contacts in series with the trip coil when the breaker is open. See the figure below for modifications to the wiring and proper resistor selection. If that continuity is broken, a Starter Failure alarm will indicate Trip Coil Supervision.

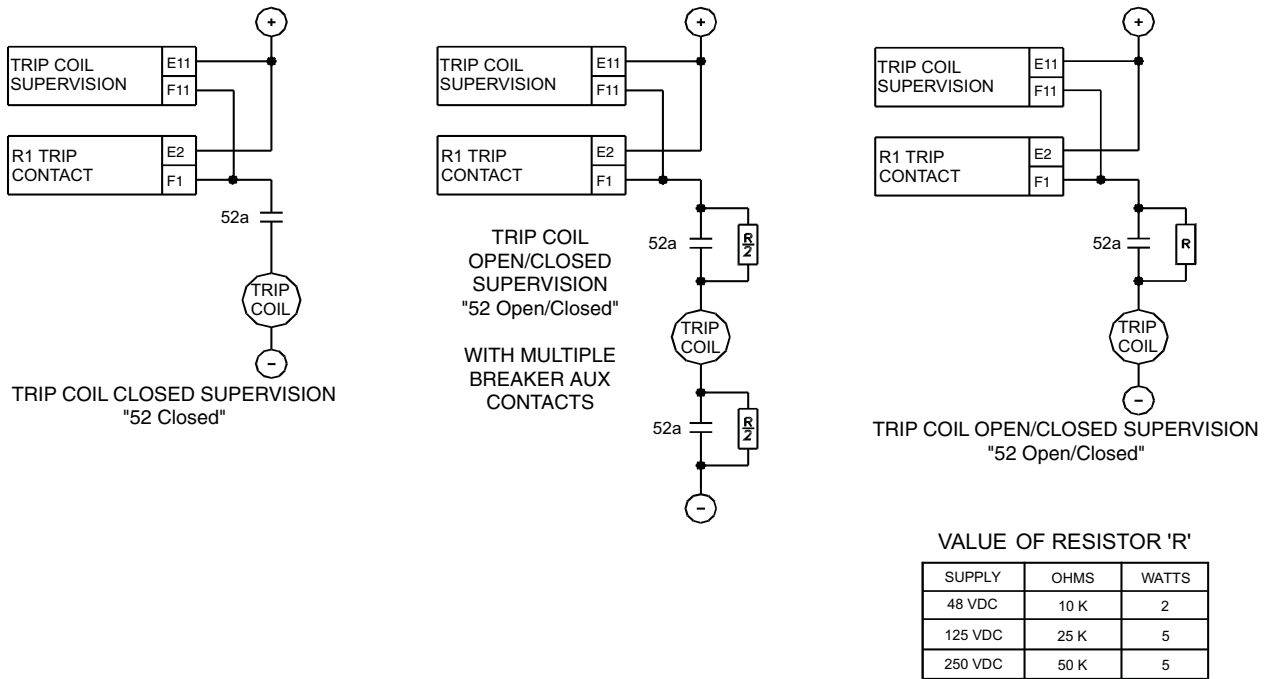
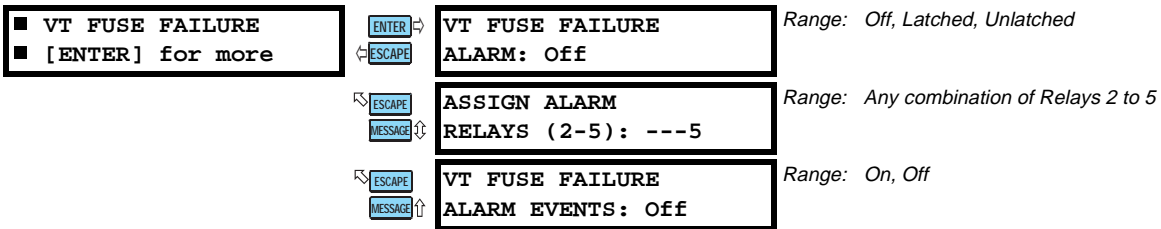

Figure 4-19: TRIP COIL SUPERVISION

4.11.4 VT FUSE FAILURE



A fuse failure is detected when there are significant levels of negative sequence voltage without correspondingly significant levels of negative sequence current measured at the output CTs. Also, if the generator is online and there is not a significant amount of positive sequence voltage, it could indicate that all the VT fuses have been pulled or the VTs have been racked out. If the alarm is enabled and a VT fuse failure has been detected elements that could nuisance operate will be blocked and an alarm will occur. Those elements that will be blocked include voltage restraint for the phase overcurrent, undervoltage, phase reversal, and all power elements.

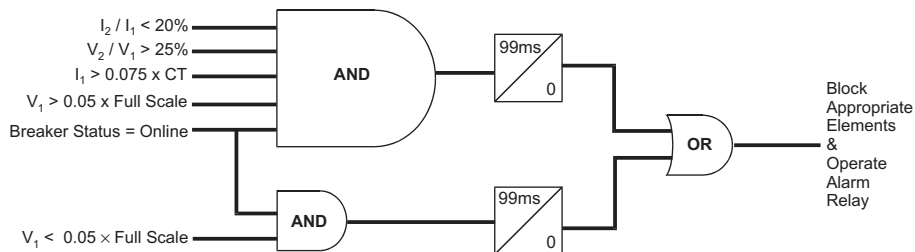

Figure 4-20: VT FUSE FAILURE

4.11.5 CURRENT, MW, MVAR, MVA DEMAND

<ul style="list-style-type: none"> ■ CURRENT DEMAND ■ [ENTER] for more 	ENTER →	CURRENT DEMAND PERIOD: 15 min.	Range: 5 to 90 min. in steps of 1
	← ESCAPE		
	ESCAPE MESSAGE ↕	CURRENT DEMAND ALARM: Off	Range: Off, Latched, Unlatched
	ESCAPE MESSAGE ↕	ASSIGN ALARM RELAYS (2-5): ---5	Range: Any combination of Relays 2 to 5
	ESCAPE MESSAGE ↕	CURRENT DEMAND LIMIT: 1.25 x FLA	Range: 0.10 to 20.00 x FLA in steps of 0.01
ESCAPE MESSAGE ↑	CURRENT DEMAND ALARM EVENTS: Off	Range: On, Off	
<ul style="list-style-type: none"> ■ MW DEMAND ■ [ENTER] for more 	ENTER →	MW DEMAND PERIOD: 15 min.	Range: 5 to 90 min. in steps of 1
	← ESCAPE		
	ESCAPE MESSAGE ↕	MW DEMAND ALARM: Off	Range: Off, Latched, Unlatched
	ESCAPE MESSAGE ↕	ASSIGN ALARM RELAYS (2-5): ---5	Range: Any combination of Relays 2 to 5
	ESCAPE MESSAGE ↕	MW DEMAND LIMIT: 1.25 x Rated	Range: 0.10 to 20.00 x Rated in steps of 0.01
ESCAPE MESSAGE ↑	MW DEMAND ALARM EVENTS: Off	Range: On, Off	
<ul style="list-style-type: none"> ■ Mvar DEMAND ■ [ENTER] for more 	ENTER →	Mvar DEMAND PERIOD: 15 min.	Range: 5 to 90 min. in steps of 1
	← ESCAPE		
	ESCAPE MESSAGE ↕	Mvar DEMAND ALARM: Off	Range: Off, Latched, Unlatched
	ESCAPE MESSAGE ↕	ASSIGN ALARM RELAYS (2-5): ---5	Range: Any combination of Relays 2 to 5
	ESCAPE MESSAGE ↕	Mvar DEMAND LIMIT: 1.25 x Rated	Range: 0.10 to 20.00 x Rated in steps of 0.01
ESCAPE MESSAGE ↑	Mvar DEMAND ALARM EVENTS: Off	Range: On, Off	
<ul style="list-style-type: none"> ■ MVA DEMAND ■ [ENTER] for more 	ENTER →	MVA DEMAND PERIOD: 15 min.	Range: 5 to 90 min. in steps of 1
	← ESCAPE		
	ESCAPE MESSAGE ↕	MVA DEMAND ALARM: Off	Range: Off, Latched, Unlatched
	ESCAPE MESSAGE ↕	ASSIGN ALARM RELAYS (2-5): ---5	Range: Any combination of Relays 2 to 5
	ESCAPE MESSAGE ↕	MVA DEMAND LIMIT: 1.25 x Rated	Range: 0.10 to 20.00 x Rated in steps of 0.01
ESCAPE MESSAGE ↑	MVA DEMAND ALARM EVENTS: Off	Range: On, Off	

The 489 can measure the demand of the generator for several parameters (current, MW, Mvar, MVA). The demand values of generators may be of interest for energy management programs where processes may be altered or scheduled to reduce overall demand on a feeder. The generator FLA is calculated as:

$$\text{Generator FLA} = \frac{\text{Generator Rated MVA}}{\sqrt{3} \times \text{Generator Rated Phase-Phase Voltage}}$$

Power quantities are programmed as per unit calculated from the rated MVA and rated power factor.

Demand is calculated in the following manner. Every minute, an average magnitude is calculated for current, +MW, +Mvar, and MVA based on samples taken every 5 seconds. These values are stored in a FIFO (First In, First Out) buffer. The size of the buffer is dictated by the period that is selected for the setpoint. The average value of the buffer contents is calculated and stored as the new demand value every minute. Demand for real and reactive power is only positive quantities (+MW and +Mvar).

$$\text{Demand} = \frac{1}{N} \sum_{n=1}^N |\text{Average}_n|$$

where: N = programmed Demand Period in minutes,
 n = time in minutes

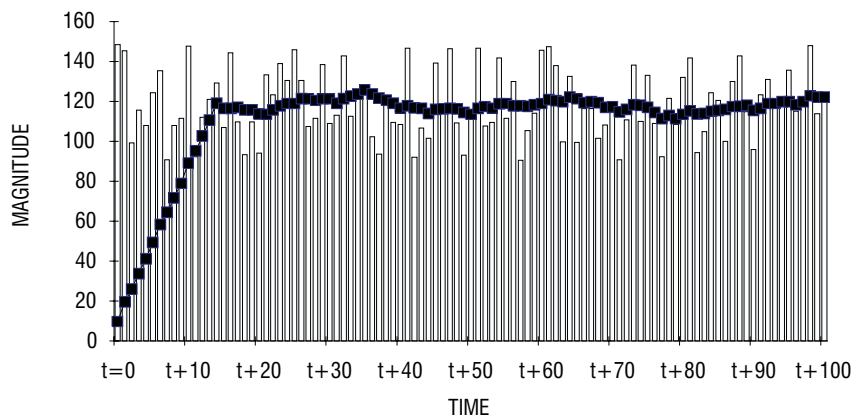

Figure 4-21: ROLLING DEMAND (15 MINUTE WINDOW)

4.11.6 PULSE OUTPUT

<ul style="list-style-type: none"> ■ PULSE OUTPUT ■ [ENTER] for more 	ENTER →	POS. kWh PULSE OUT RELAYS (2-5): ----	Range: Any combination of Relays 2 to 5
	← ESCAPE	POS. kWh PULSE OUT INTERVAL: 10 kWh	Range: 1 to 50000 kWh in steps of 1
	↻ ESCAPE	POS. kvarh PULSE OUT RELAYS (2-5): ----	Range: Any combination of Relays 2 to 5
	↻ ESCAPE	POS. kvarh PULSE OUT INTERVAL: 10 kvarh	Range: 1 to 50000 kvarh in steps of 1
	↻ ESCAPE	NEG. kvarh PULSE OUT RELAYS (2-5): ----	Range: Any combination of Relays 2 to 5
	↻ ESCAPE	NEG. kvarh PULSE OUT INTERVAL: 10 kvarh	Range: 1 to 50000 kvarh in steps of 1
	↻ ESCAPE	PULSE WIDTH: 200 ms	Range: 200 to 1000 ms in steps of 1

The 489 can perform pulsed output of positive kWh and both positive and negative kvarh. Each output parameter can be assigned to any one of the alarm or auxiliary relays. Pulsed output is disabled for a parameter if the relay setpoint is selected as OFF for that pulsed output. The minimum time between pulses is fixed to 400 milliseconds.



This feature should be programmed such that no more than one pulse per 600 milliseconds is required or the pulsing will lag behind the interval activation. Do not assign pulsed outputs to the same relays as alarms and trip functions.

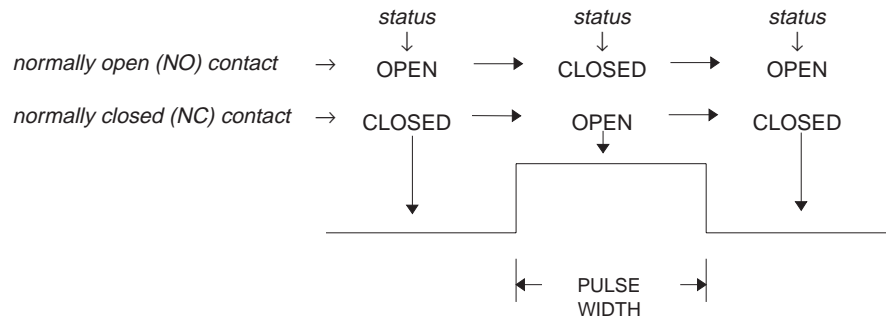

Figure 4-22: PULSE OUTPUT

4.11.7 GENERATOR RUNNING HOUR SETUP

<ul style="list-style-type: none"> ■ RUNNING HOUR SETUP ■ [ENTER] for more 	ENTER →	INITIAL GEN. RUNNING HOURS: 0 h	Range: 0 to 999999 h in steps of 1
	← ESCAPE	GEN. RUNNING HOURS ALARM: off	Range: Off, Latched, Unlatched
	↻ ESCAPE	ASSIGN ALARM RELAYS (2-5): ---5	Range: Any combination of Relays 2 to 5
	↻ ESCAPE	GEN. RUNNING HOURS LIMIT: 1000 h	Range: 1 to 1000000 h in steps of 1
	↻ ESCAPE		

The 489 can measure the generator running hours. This value may be of interest for periodic maintenance of the generator. The initial generator running hour allows the user to program existing accumulated running hours on a particular generator the relay is protecting. This feature switching 489 relays without losing previous generator running hour values.

4.12.1 ANALOG OUTPUTS 1 TO 4

<ul style="list-style-type: none"> ■ ANALOG OUTPUT 1 ■ [ENTER] for more 	[ENTER] → ← [ESCAPE]	ANALOG OUTPUT 1: Real Power (MW)	<i>Range: See Table 4–8: ANALOG OUTPUT PARAMETER SELECTION on page 4–71.</i>
	↻ [ESCAPE] [MESSAGE] ⇕	REAL POWER (MW) MIN: 0.00 x Rated	<i>Range: 0.00 to 2.00 x Rated in steps of 0.01</i>
	↻ [ESCAPE] [MESSAGE] ↑	REAL POWER (MW) MAX: 1.25 x Rated	<i>Range: 0.00 to 2.00 x Rated in steps of 0.01</i>
<ul style="list-style-type: none"> ■ ANALOG OUTPUT 2 ■ [ENTER] for more 	[ENTER] → ← [ESCAPE]	ANALOG OUTPUT 2: Apparent Power (MVA)	<i>Range: See Table 4–8: ANALOG OUTPUT PARAMETER SELECTION on page 4–71.</i>
	↻ [ESCAPE] [MESSAGE] ⇕	APPARENT POWER (MVA) MIN: 0.00 x Rated	<i>Range: 0.00 to 2.00 x Rated in steps of 0.01</i>
	↻ [ESCAPE] [MESSAGE] ↑	APPARENT POWER (MVA) MAX: 1.25 x Rated	<i>Range: 0.00 to 2.00 x Rated in steps of 0.01</i>
<ul style="list-style-type: none"> ■ ANALOG OUTPUT 3 ■ [ENTER] for more 	[ENTER] → ← [ESCAPE]	ANALOG OUTPUT 3: Avg. Output Current	<i>Range: See Table 4–8: ANALOG OUTPUT PARAMETER SELECTION on page 4–71.</i>
	↻ [ESCAPE] [MESSAGE] ⇕	AVG. OUTPUT CURRENT MIN: 0.00 x FLA	<i>Range: 0.00 to 20.00 x Rated in steps of 0.01</i>
	↻ [ESCAPE] [MESSAGE] ↑	AVG. OUTPUT CURRENT MAX: 1.25 x FLA	<i>Range: 0.00 to 20.00 x Rated in steps of 0.01</i>
<ul style="list-style-type: none"> ■ ANALOG OUTPUT 4 ■ [ENTER] for more 	[ENTER] → ← [ESCAPE]	ANALOG OUTPUT 4: Average Voltage	<i>Range: See Table 4–8: ANALOG OUTPUT PARAMETER SELECTION on page 4–71.</i>
	↻ [ESCAPE] [MESSAGE] ⇕	AVERAGE VOLTAGE MIN: 0.00 x Rated	<i>Range: 0.00 to 1.50 x Rated in steps of 0.01</i>
	↻ [ESCAPE] [MESSAGE] ↑	AVERAGE VOLTAGE MAX: 1.25 x Rated	<i>Range: 0.00 to 1.50 x Rated in steps of 0.01</i>

The 489 has four analog output channels (4 to 20 mA or 0 to 1 mA as ordered). Each channel may be individually configured to represent a number of different measured parameters as shown in the table below. The minimum value programmed represents the 4 mA output. The maximum value programmed represents the 20 mA output. All four of the outputs are updated once every 50 ms. Each parameter may only be used once.

The analog output parameter may be chosen as Real Power (MW) for a 4 to 20 mA output. If rated power is 100 MW, the minimum is set for $0.00 \times \text{Rated}$, and the maximum is set for $1.00 \times \text{Rated}$, the analog output channel will output 4 mA when the real power measurement is 0 MW. When the real power measurement is 50 MW, the analog output channel will output 12 mA. When the real power measurement is 100 MW, the analog output channel will output 20 mA.

Table 4-8: ANALOG OUTPUT PARAMETER SELECTION

PARAMETER NAME	RANGE / UNITS	STEP	DEFAULT	
			MIN.	MAX
IA Output Current	0.00 to 20.00 × FLA	0.01	0.00	1.25
IB Output Current	0.00 to 20.00 × FLA	0.01	0.00	1.25
IC Output Current	0.00 to 20.00 × FLA	0.01	0.00	1.25
Avg. Output Current	0.00 to 20.00 × FLA	0.01	0.00	1.25
Neg. Seq. Current	0 to 2000% FLA	1	0	100
Averaged Gen. Load	0.00 to 20.00 × FLA	0.01	0.00	1.25
Hottest Stator RTD	-50 to +250°C or -58 to +482°F	1	0	200
Hottest Bearing RTD	-50 to +250°C or -58 to +482°F	1	0	200
Ambient RTD	-50 to +250°C or -58 to +482°F	1	-50	60
RTDs 1 to 12	-50 to +250°C or -58 to +482°F	1	-50	250
AB Voltage	0.00 to 1.50 × Rated	0.01	0.00	1.25
BC Voltage	0.00 to 1.50 × Rated	0.01	0.00	1.25
CA Voltage	0.00 to 1.50 × Rated	0.01	0.00	1.25
Volts/Hertz	0.00 to 2.00 × Rated	0.01	0.00	1.50
Frequency	0.00 to 90.00 Hz	0.01	59.00	61.00
Neutral Volt. (3rd)	0 to 25000 V	0.1	0.0	45.0
Average Voltage	0.00 to 1.50 × Rated	0.01	0.00	1.25
Power Factor	0.01 to 1.00 lead/lag	0.01	0.8 lag	0.8 lead
Reactive Power (Mvar)	-2.00 to 2.00 × Rated	0.01	0.00	1.25
Real Power	-2.00 to 2.00 × Rated	0.01	0.00	1.25
Apparent Power	0.00 to 2.00 × Rated	0.01	0.00	1.25
Analog Inputs 1 to 4	-50000 to +50000	1	0	50000
Tachometer	0 to 7200 RPM	1	3500	3700
Thermal Capacity Used	0 to 100%	1	0	100
Current Demand	0.00 to 20.00 × FLA	0.01	0.00	1.25
Mvar Demand	0.00 to 2.00 × Rated	0.01	0.00	1.25
MW Demand	0.00 to 2.00 × Rated	0.01	0.00	1.25
MVA Demand	0.00 to 2.00 × Rated	0.01	0.00	1.25

4.12.2 ANALOG INPUTS 1 TO 4

■ ANALOG INPUT 1
 ■ [ENTER] for more

<div style="border: 1px solid black; padding: 2px; width: 40px; margin: 0 auto;">ENTER</div>	ANALOG INPUT1: Disabled	<i>Range: Disabled, 4-20 mA, 0-20 mA, 0-1 mA</i>
<div style="border: 1px solid black; padding: 2px; width: 40px; margin: 0 auto;">ESCAPE</div>	ANALOG INPUT1 NAME: Analog I/P 1	<i>Range: 12 alphanumeric characters</i>
<div style="border: 1px solid black; padding: 2px; width: 40px; margin: 0 auto;">ESCAPE</div>	ANALOG INPUT1 UNITS: Units	<i>Range: 6 alphanumeric characters</i>
<div style="border: 1px solid black; padding: 2px; width: 40px; margin: 0 auto;">ESCAPE</div>	ANALOG INPUT1 MINIMUM: 0	<i>Range: -50000 to 50000 in steps of 1</i>
<div style="border: 1px solid black; padding: 2px; width: 40px; margin: 0 auto;">ESCAPE</div>	ANALOG INPUT1 MAXIMUM: 100	<i>Range: -50000 to 50000 in steps of 1</i>
<div style="border: 1px solid black; padding: 2px; width: 40px; margin: 0 auto;">ESCAPE</div>	BLOCK ANALOG INPUT1 FROM ONLINE: 0 s	<i>Range: 0 to 5000 sec. in steps of 1</i>

ESCAPE MESSAGE	ANALOG INPUT1 ALARM: Off	Range: Off, Latched, Unlatched
ESCAPE MESSAGE	ASSIGN ALARM RELAYS (2-5): ---5	Range: Any combination of Relays 2 to 5
ESCAPE MESSAGE	ANALOG INPUT1 ALARM LEVEL: 10 Units	Range: -50000 to 50000 in steps of 1 Units will reflect ANALOG INPUT 1 UNITS above
ESCAPE MESSAGE	ANALOG INPUT1 ALARM PICKUP: Over	Range: Over, Under
ESCAPE MESSAGE	ANALOG INPUT1 ALARM DELAY: 0.1 s	Range: 0.1 to 300.0 s in steps of 0.1
ESCAPE MESSAGE	ANALOG INPUT1 ALARM EVENTS: Off	Range: On, Off
ESCAPE MESSAGE	ANALOG INPUT1 TRIP: Off	Range: Off, Latched, Unlatched
ESCAPE MESSAGE	ASSIGN TRIP RELAYS (1-4): 1---	Range: Any combination of Relays 1 to 4
ESCAPE MESSAGE	ANALOG INPUT1 TRIP LEVEL: 20 Units	Range: -50000 to 50000 in steps of 1 Units will reflect ANALOG INPUT 1 UNITS above
ESCAPE MESSAGE	ANALOG INPUT1 TRIP PICKUP: Over	Range: Over, Under
ESCAPE MESSAGE	ANALOG INPUT1 TRIP DELAY: 0.1 s	Range: 0.1 to 300.0 s in steps of 0.1

There are 4 analog inputs (4 to 20 mA, 0 to 20 mA, or 0 to 1 mA) that may be used to monitor transducers such as vibration monitors, tachometers, pressure transducers, etc. These inputs may be used for alarm and/or tripping purposes. The inputs are sampled every 50 ms. The level of the analog input is also available over the communications port. With the 489PC program, the level of the transducer may be trended and graphed.

Before the input may be used, it must be configured. A name may be assigned for the input, units may be assigned, and a minimum and maximum value must be assigned. Also, the trip and alarm features may be blocked until the generator is online for a specified time delay. If the block time is 0 seconds, there is no block and the trip and alarm features will be active when the generator is offline or online. If a time is programmed other than 0 seconds, the feature will be disabled when the generator is offline and also from the time the machine is placed online until the time entered expires. Once the input is setup, both the trip and alarm features may be configured. In addition to programming a level and time delay, the PICKUP setpoint may be used to dictate whether the feature picks up when the measured value is over or under the level.

If a vibration transducer is to be used, program the name as "Vibration Monitor", the units as "mm/s", the minimum as "0", the maximum as "25", and the Block From Online as "0 s". Set the alarm for a reasonable level slightly higher than the normal vibration level. Program a delay of "3 s" and the pickup as "Over".

4.13.1 SIMULATION MODE

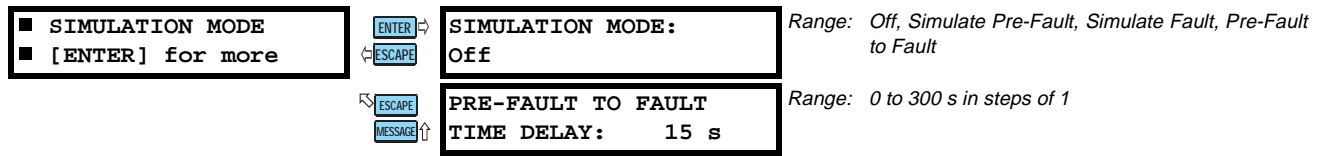

The 489 may be placed in several simulation modes. This simulation may be useful for several purposes. First, it may be used to understand the operation of the 489 for learning or training purposes. Second, simulation may be used during startup to verify that control circuitry operates as it should in the event of a trip or alarm. In addition, simulation may be used to verify that setpoints had been set properly in the event of fault conditions.

The **SIMULATION MODE** setpoint may be entered only if the generator is offline, no current is measured, and there are no trips or alarms active. The values entered as Pre-Fault Values will be substituted for the measured values in the 489 when the **SIMULATION MODE** is "Simulate Pre-Fault". The values entered as Fault Values will be substituted for the measured values in the 489 when the **SIMULATION MODE** is "Simulate Fault". If the **SIMULATION MODE** is set to "Pre-Fault to Fault", the Pre-Fault values will be substituted for the period of time specified by the delay, followed by the Fault values. If a trip occurs, the **SIMULATION MODE** reverts to "Off". Selecting "Off" for the **SIMULATION MODE** places the 489 back in service. If the 489 measures current or control power is cycled, the **SIMULATION MODE** automatically reverts to "Off".

If the 489 is to be used for training, it might be desirable to allow all parameter averages, statistical information, and event recording to update when operating in simulation mode. If however, the 489 has been installed and will remain installed on a specific generator, it might be desirable assign a digital input to Test Input and to short that input to prevent all of this data from being corrupted or updated. In any event, when in simulation mode, the 489 in Service LED (indicator) will flash, indicating that the 489 is not in protection mode.

4.13.2 PRE-FAULT SETUP

<p>■ PRE-FAULT SETUP</p> <p>■ [ENTER] for more</p>	<p>ENTER →</p> <p>← ESCAPE</p>	<p>PRE-FAULT Iphase</p> <p>OUTPUT: 0.00 x CT</p>	<p>Range: 0.00 to 20.00 x CT in steps of 0.01</p>
	<p>ESCAPE ↶</p> <p>MESSAGE ⇅</p>	<p>PRE-FAULT VOLTAGES</p> <p>PHASE-N: 1.00 x Rated</p>	<p>Range: 0.00 to 1.50 x Rated in steps of 0.01</p> <p>Entered as a phase-to-neutral quantity.</p>
	<p>ESCAPE ↶</p> <p>MESSAGE ⇅</p>	<p>PRE-FAULT CURRENT</p> <p>LAGS VOLTAGE: 0°</p>	<p>Range: 0 to 359° in steps of 1</p>
	<p>ESCAPE ↶</p> <p>MESSAGE ⇅</p>	<p>PRE-FAULT Iphase</p> <p>NEUTRAL: 0.00 x CT</p>	<p>Range: 0.00 to 20.00 x CT in steps of 0.01</p> <p>180° phase shift with respect to Iphase OUTPUT</p>
	<p>ESCAPE ↶</p> <p>MESSAGE ⇅</p>	<p>PRE-FAULT CURRENT</p> <p>GROUND: 0.00 x CT</p>	<p>Range: 0.00 to 20.00 x CT in steps of 0.01</p> <p>CT is either XXX:1 or 50:0.025</p>
	<p>ESCAPE ↶</p> <p>MESSAGE ⇅</p>	<p>PRE-FAULT VOLTAGE</p> <p>NEUTRAL: 0 Vsec</p>	<p>Range 0.0 to 100.0 Vsec in steps of 0.1</p> <p>Fundamental value only in secondary units</p>
	<p>ESCAPE ↶</p> <p>MESSAGE ⇅</p>	<p>PRE-FAULT STATOR</p> <p>RTD TEMP: 40°C</p>	<p>Range: -50 to 250°C in steps of 1</p>
	<p>ESCAPE ↶</p> <p>MESSAGE ⇅</p>	<p>PRE-FAULT BEARING</p> <p>RTD TEMP: 40°C</p>	<p>Range: -50 to 250°C in steps of 1</p>
	<p>ESCAPE ↶</p> <p>MESSAGE ⇅</p>	<p>PRE-FAULT OTHER</p> <p>RTD TEMP: 40°C</p>	<p>Range: -50 to 250°C in steps of 1</p>
	<p>ESCAPE ↶</p> <p>MESSAGE ⇅</p>	<p>PRE-FAULT AMBIENT</p> <p>RTD TEMP: 40°C</p>	<p>Range: -50 to 250°C in steps of 1</p>
	<p>ESCAPE ↶</p> <p>MESSAGE ⇅</p>	<p>PRE-FAULT SYSTEM</p> <p>FREQUENCY: 60.0 Hz</p>	<p>Range: 5.0 to 90.0 Hz in steps of 0.1</p>
	<p>ESCAPE ↶</p> <p>MESSAGE ⇅</p>	<p>PRE-FAULT ANALOG</p> <p>INPUT 1: 0%</p>	<p>Range: 0 to 100% in steps of 1</p>
	<p>ESCAPE ↶</p> <p>MESSAGE ⇅</p>	<p>PRE-FAULT ANALOG</p> <p>INPUT 2: 0%</p>	<p>Range: 0 to 100% in steps of 1</p>
	<p>ESCAPE ↶</p> <p>MESSAGE ⇅</p>	<p>PRE-FAULT ANALOG</p> <p>INPUT 3: 0%</p>	<p>Range: 0 to 100% in steps of 1</p>
<p>ESCAPE ↶</p> <p>MESSAGE ⇅</p>	<p>PRE-FAULT ANALOG</p> <p>INPUT 4: 0%</p>	<p>Range: 0 to 100% in steps of 1</p>	

The values entered under Pre-Fault Values will be substituted for the measured values in the 489 when the **SIMULATION MODE** is "Simulate Pre-Fault".

4.13.3 FAULT SETUP

<ul style="list-style-type: none"> ■ FAULT SETUP ■ [ENTER] for more 	ENTER →	FAULT Iphase	Range: 0.00 to 20.00 × CT in steps of 0.01
	← ESCAPE	OUTPUT: 0.00 × CT	
	↻ ESCAPE	FAULT VOLTAGES	Range: 0.00 to 1.50 × Rated in steps of 0.01
	MESSAGE ↕	PHASE-N: 1.00 × Rated	Entered as a phase-to-neutral quantity.
	↻ ESCAPE	FAULT CURRENT	Range: 0 to 359° in steps of 1
	MESSAGE ↕	LAGS VOLTAGE: 0°	
	↻ ESCAPE	FAULT Iphase	Range: 0.00 to 20.00 × CT in steps of 0.01
	MESSAGE ↕	NEUTRAL: 0.00 × CT	180° phase shift with respect to Iphase OUTPUT
	↻ ESCAPE	FAULT CURRENT	Range: 0.00 to 20.00 × CT in steps of 0.01
	MESSAGE ↕	GROUND: 0.00 × CT	CT is either XXX:1 or 50:0.025
	↻ ESCAPE	FAULT VOLTAGE	Range: 0.0 to 100.0 Vsec in steps of 0.1
	MESSAGE ↕	NEUTRAL: 0 Vsec	Fundamental value only in secondary volts
	↻ ESCAPE	FAULT STATOR	Range: -50 to 250°C in steps of 1
	MESSAGE ↕	RTD TEMP: 40°C	
↻ ESCAPE	FAULT BEARING	Range: -50 to 250°C in steps of 1	
MESSAGE ↕	RTD TEMP: 40°C		
↻ ESCAPE	FAULT OTHER	Range: -50 to 250°C in steps of 1	
MESSAGE ↕	RTD TEMP: 40°C		
↻ ESCAPE	FAULT AMBIENT	Range: -50 to 250°C in steps of 1	
MESSAGE ↕	RTD TEMP: 40°C		
↻ ESCAPE	FAULT SYSTEM	Range: 5.0 to 90.0 Hz in steps of 0.1	
MESSAGE ↕	FREQUENCY: 60.0 Hz		
↻ ESCAPE	FAULT ANALOG	Range: 0 to 100% in steps of 1	
MESSAGE ↕	INPUT 1: 0%		
↻ ESCAPE	FAULT ANALOG	Range: 0 to 100% in steps of 1	
MESSAGE ↕	INPUT 2: 0%		
↻ ESCAPE	FAULT ANALOG	Range: 0 to 100% in steps of 1	
MESSAGE ↕	INPUT 3: 0%		
↻ ESCAPE	FAULT ANALOG	Range: 0 to 100% in steps of 1	
MESSAGE ↕	INPUT 4: 0%		



The values entered under Fault Values will be substituted for the measured values in the 489 when the **SIMULATION MODE** is "Simulate Fault".

4.13.4 TEST OUTPUT RELAYS

<ul style="list-style-type: none"> ■ TEST OUTPUT RELAYS ■ [ENTER] for more 	ENTER →	FORCE OPERATION OF	Range: Disabled, R1 Trip, R2 Auxiliary, R3 Auxiliary, R4 Auxiliary, R5 Alarm, R6 Service, All Relays, No Relays
	← ESCAPE	RELAYS: Disabled	

The test output relays setpoint may be used during startup or testing to verify that the output relays are functioning correctly. The output relays can be forced to operate only if the generator is offline, no current is measured, and there are no trips or alarms active. If any relay is forced to operate, the relay will toggle from its normal state when there are no trips or alarms to its operated state. The appropriate relay indicator will illuminate at that time. Selecting "Disabled" places the output relays back in service. If the 489 measures current or control power is cycled, the force operation of relays setpoint will automatically become disabled and the output relays will revert back to their normal states.

If any relay is forced, the 489 in Service indicator will flash, indicating that the 489 is not in protection mode.

4.13.5 TEST ANALOG OUTPUT

<ul style="list-style-type: none"> ■ TEST ANALOG OUTPUT ■ [ENTER] for more 	ENTER →	FORCE ANALOG OUTPUTS	Range: Enabled, Disabled
	← ESCAPE	FUNCTION: Disabled	
	↩ ESCAPE	ANALOG OUTPUT 1	Range: 0 to 100% in steps of 1
	MESSAGE ⇅	FORCED VALUE: 0%	
	↩ ESCAPE	ANALOG OUTPUT 2	Range: 0 to 100% in steps of 1
MESSAGE ⇅	FORCED VALUE: 0%		
↩ ESCAPE	ANALOG OUTPUT 3	Range: 0 to 100% in steps of 1	
MESSAGE ⇅	FORCED VALUE: 0%		
↩ ESCAPE	ANALOG OUTPUT 4	Range: 0 to 100% in steps of 1	
MESSAGE ⇅	FORCED VALUE: 0%		

These setpoints may be used during startup or testing to verify that the analog outputs are functioning correctly. The analog outputs can be forced only if the generator is offline, no current is measured, and there are no trips or alarms active. When the **FORCE ANALOG OUTPUTS FUNCTION** is "Enabled", the output reflects the forced value as a percentage of the range 4 to 20 mA or 0 to 1 mA. Selecting "Disabled" places all four analog output channels back in service, reflecting their programmed parameters. If the 489 measures current or control power is cycled, the force analog output function is automatically disabled and all analog outputs will revert back to their normal state.

Any time the analog outputs are forced, the In Service indicator will flash, indicating that the 489 is not in protection mode.

4.13.6 COMM PORT MONITOR

<ul style="list-style-type: none"> ■ COMM PORT MONITOR ■ [ENTER] for more 	ENTER →	MONITOR COMM. PORT:	Range: Computer RS485, Auxiliary RS485, Front Panel RS232
	← ESCAPE	Computer RS485	
	↩ ESCAPE	CLEAR COMM. BUFFERS:	Range: No, Yes
	MESSAGE ⇅	No	
	↩ ESCAPE	LAST Rx BUFFER:	Range: Buffer Cleared, Received OK, Wrong Slave Addr., Illegal Function, Illegal Count, Illegal Reg. Addr., CRC Error, Illegal Data
	MESSAGE ⇅	Received OK	
	↩ ESCAPE	Rx1: 02,03,00,67,00,	Range: received data in HEX
	MESSAGE ⇅	03,B4,27	
	↩ ESCAPE	Rx2:	Range: received data in HEX
	MESSAGE ⇅		
↩ ESCAPE	Tx1: 02,03,06,00,64,	Range: received data in HEX	
MESSAGE ⇅	00,0A,00,0F		
↩ ESCAPE	Tx2:	Range: received data in HEX	
MESSAGE ⇅			

During communications troubleshooting, it can be useful to see the data being transmitted to the 489 from some master device, as well as the data transmitted back to that master device. The messages shown here make it possible to view that data. Any of the three communications ports may be monitored. After the communications buffers are cleared, any data received from the monitored communications port is stored in Rx1 and Rx2. If the 489 transmits a message, it appears in the Tx1 and Tx2 buffers. In addition to these buffers, there is a message indicating the status of the last received message.

4.13.7 FACTORY SERVICE

<ul style="list-style-type: none"> ■ FACTORY SERVICE ■ [ENTER] for more 	ENTER →	ENTER FACTORY	Range: N/A
	← ESCAPE	PASSCODE: 0	

This section is for use by GE Power Management personnel for testing and calibration purposes.

5.1.1 ACTUAL VALUES MESSAGES

Measured values, maintenance and fault analysis information are accessed in the Actual Value mode. Actual values may be accessed via one of the following methods:

1. Front panel, using the keys and display.
2. Front program port, and a portable computer running the 489PC software supplied with the relay.
3. Rear terminal RS485 port, and a PLC/SCADA system running user-written software.

Any of these methods can be used to view the same information. However, a computer makes viewing much more convenient since many variables may be viewed simultaneously.

Actual value messages are organized into logical groups, or pages, for easy reference, as shown below. All actual value messages are illustrated and described in blocks throughout this chapter. All values shown in these message illustrations assume that no inputs (besides control power) are connected to the 489.

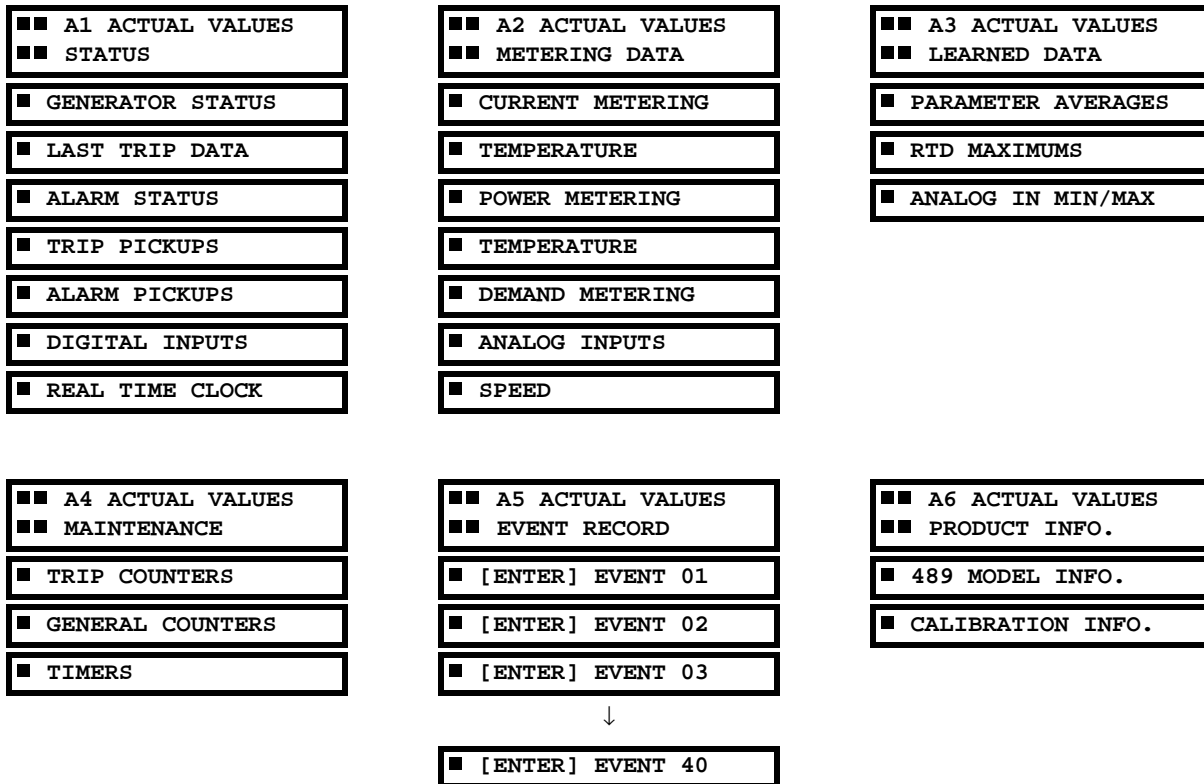

In addition to the actual value messages, there are also diagnostic and flash messages that appear only when certain conditions occur. They are described later in this chapter.

5.2.1 GENERATOR STATUS

<ul style="list-style-type: none"> ■ GENERATOR STATUS ■ [ENTER] for more 	ENTER → ← ESCAPE	GENERATOR STATUS: Offline	Range: Online, Offline, Tripped
	↻ ESCAPE MESSAGE ⇅	GENERATOR THERMAL CAPACITY USED: 0%	Range: 0 to 100% Seen only if the Thermal Model is enabled
	↻ ESCAPE MESSAGE ⇅	ESTIMATED TRIP TIME ON OVERLOAD: Never	Range: 0 to 10000 sec., Never Seen only if the Thermal Model is enabled

These messages describe the status of the generator at any given point in time. If the generator has been tripped, is still offline, and the 489 has not yet been reset, the **GENERATOR STATUS** will be "Tripped". The **GENERATOR THERMAL CAPACITY USED** value reflects an integrated value of both the stator and rotor thermal capacity used. The values for **ESTIMATED TRIP TIME ON OVERLOAD** will appear whenever the 489 thermal model picks up on the overload curve.

5.2.2 LAST TRIP DATA

<ul style="list-style-type: none"> ■ LAST TRIP DATA ■ [ENTER] for more 	ENTER → ← ESCAPE	CAUSE OF LAST TRIP: No Trip to Date	Range: No Trip to Date, General Input A to G, Sequential Trip, Field-Bkr Discrep., Tachometer, Thermal Model, Offline Overcurrent, Phase Overcurrent, Neg. Seq. Overcurrent, Ground Overcurrent, Phase Differential, RTDs 1 to 12, Overvoltage, Undervoltage, Volts/Hertz, Phase Reversal, Underfrequency, Overfrequency, Neutral O/V, Neutral U/V (3rd), Reactive Power, Reverse Power, Low Forward Power, Inadvertent Energ., Analog Inputs 1 to 4
	↻ ESCAPE MESSAGE ⇅	TIME OF LAST TRIP: 09:00:00.00	Range: hour:min:sec
	↻ ESCAPE MESSAGE ⇅	DATE OF LAST TRIP: Jan 01 1995	Range: Month Day Year
	↻ ESCAPE MESSAGE ⇅	TACHOMETER PRETRIP: 3600 RPM	Range: 0 to 3600 RPM Seen only if Tachometer is assigned as an input.
	↻ ESCAPE MESSAGE ⇅	A: 0 B: 0 C: 0 A PreTrip	Range: 0 to 999999 A. Represents current measured from output CTs. Seen only if a trip has occurred.
	↻ ESCAPE MESSAGE ⇅	a: 0 b: 0 c: 0 DA PreTrip	Range: 0 to 999999 A. Represents differential current. Seen only if differential element is enabled.
	↻ ESCAPE MESSAGE ⇅	NEG. SEQ. CURRENT PRETRIP: 0% FLA	Range: 0 to 2000% FLA Seen only if there has been a trip.
	↻ ESCAPE MESSAGE ⇅	GROUND CURRENT PRETRIP: 0.00 A	Range: 0.00 to 200000.00 A Not seen if GROUND CT is "None"
	↻ ESCAPE MESSAGE ⇅	GROUND CURRENT PRETRIP: 0.00 Amps	Range: 0.0 to 5000.0 A
	↻ ESCAPE MESSAGE ⇅	Vab: 0 Vbc: 0 Vca: 0 V PreTrip	Range: 0 to 50000 V Not seen if VT CONNECTION is "None"
	↻ ESCAPE MESSAGE ⇅	FREQUENCY PRETRIP: 0.00 Hz	Range: 0.00 to 90.00 Hz Not seen if VT CONNECTION is "None"
	↻ ESCAPE MESSAGE ⇅	NEUTRAL VOLT (FUND) PRETRIP: 0.0 V	Range: 0.0 to 25000.0 V Seen only if there is a neutral voltage transformer.
	↻ ESCAPE MESSAGE ⇅	NEUTRAL VOLT (3rd) PRETRIP: 0.0 V	Range: 0.0 to 25000.0 V Seen only if there is a neutral voltage transformer.

ESCAPE MESSAGE	REAL POWER (MW) PRETRIP: 0.000	Range: 0.000 to ±2000.000 MW Not seen if VT CONNECTION is "None"
ESCAPE MESSAGE	REACTIVE POWER Mvar PRETRIP: 0.00 Hz	Range: 0.000 to ±2000.000 Mvar Not seen if VT CONNECTION is "None"
ESCAPE MESSAGE	APPARENT POWER MVA PRETRIP: 0.00 Hz	Range: 0.000 to ±2000.000 MVA Not seen if VT CONNECTION is "None"
ESCAPE MESSAGE	HOTTEST STATOR RTD RTD #1: 0°C PreTrip	Range: -50 to 250°C Seen only if at least one RTD is "Stator"
ESCAPE MESSAGE	HOTTEST BEARING RTD RTD #7: 0°C PreTrip	Range: -50 to 250°C Seen only if at least one RTD is "Bearing"
ESCAPE MESSAGE	HOTTEST OTHER RTD RTD #11: 0°C PreTrip	Range: -50 to 250°C Seen only if at least one RTD is "Other"
ESCAPE MESSAGE	AMBIENT RTD RTD#12: 0°C PreTrip	Range: -50 to 250°C Seen only if at least one RTD is Ambient
ESCAPE MESSAGE	ANALOG INPUT 1 PreTrip: 0 Units	Range: -50000 to 50000 Not seen if VT Connection is "None"
ESCAPE MESSAGE	ANALOG INPUT 2 PreTrip: 0 Units	Range: -50000 to 50000 Not seen if VT Connection is "None"
ESCAPE MESSAGE	ANALOG INPUT 3 PreTrip: 0 Units	Range: -50000 to 50000 Not seen if VT Connection is "None"
ESCAPE MESSAGE	ANALOG INPUT 4 PreTrip: 0 Units	Range: -50000 to 50000 Not seen if VT Connection is "None"
ESCAPE MESSAGE	Vab/Iab PreTrip: 0.0 Ωsec. 0°	Range: 0 to 65535 Ωsec; 0 to 359° Seen only if Loss of Excitation is enabled

Immediately prior to issuing a trip, the 489 takes a snapshot of generator parameters and stores them as pre-trip values; this allows for troubleshooting after the trip occurs. The cause of last trip message is updated with the current trip and the screen defaults to that message. All trip features are automatically logged as date and time stamped events as they occur. This information can be cleared using the **S1 489 SETUP \ CLEAR DATA \ CLEAR LAST TRIP DATA** setpoint. If the cause of last trip is "No Trip To Date", the subsequent pretrip messages will not appear. Last Trip Data will not update if a digital input programmed as Test Input is shorted.

5.2.3 ALARM STATUS

■ ALARM STATUS ■ [ENTER] for more	ENTER ESCAPE	NO ALARMS	Range: N/A Message seen when no alarms are active
	ESCAPE MESSAGE	Input A ALARM STATUS: Active	Range: Active, Latched. The first line of this alarm message reflects the Input Name as programmed. Status is Active if the condition that caused the alarm is still present
	ESCAPE MESSAGE	Input B ALARM STATUS: Active	Range: see Input A ALARM STATUS
	ESCAPE MESSAGE	Input C ALARM STATUS: Active	Range: see Input A ALARM STATUS
	ESCAPE MESSAGE	Input D ALARM STATUS: Active	Range: see Input A ALARM STATUS
	ESCAPE MESSAGE	Input E ALARM STATUS: Active	Range: see Input A ALARM STATUS























ESCAPE MESSAGE	Input F ALARM STATUS: Active	Range: see Input A ALARM STATUS
ESCAPE MESSAGE	Input G ALARM STATUS: Active	Range: see Input A ALARM STATUS
ESCAPE MESSAGE	TACHOMETER ALARM: 3000 RPM	Range: 0 to 3600 RPM. The current Tachometer Digital Input value is shown here
ESCAPE MESSAGE	OVERCURRENT ALARM: 10.00 x FLA	Range: 0.00 to 20.00 x FLA The overcurrent level is shown here.
ESCAPE MESSAGE	NEG. SEQ. CURRENT ALARM: 15% FLA	Range: 0 to 100% FLA. Reflects the present negative-sequence current level.
ESCAPE MESSAGE	GROUND OVERCURRENT ALARM: 5.00 A	Range: 0.00 to 200000.00 A. Seen only if the GE HGF CT is used. Reflects the present ground current level.
ESCAPE MESSAGE	GROUND DIRECTIONAL ALARM: 5.00 A	Range: 0.00 to 200000.00 A
ESCAPE MESSAGE	UNDERVOLTAGE ALARM Vab= 3245 V 78% Rated	Range: 0 to 20000 V; 50 to 99% of Rated. The lowest phase-to-phase voltage value is shown here
ESCAPE MESSAGE	OVERVOLTAGE ALARM Vab= 4992 V 120% Rated	Range: 0 to 20000 V; 101 to 150% of Rated. The lowest phase-to-phase voltage is shown here
ESCAPE MESSAGE	VOLTS/HERTZ ALARM PER UNIT V/Hz: 1.15	Range: 0.00 to 2.00. The present V/Hz value is shown here. Not seen if VT CONNECTION is None.
ESCAPE MESSAGE	UNDERFREQUENCY ALARM: 59.4 Hz	Range: 0.00 to 90.00 Hz Reflects the present voltage frequency value.
ESCAPE MESSAGE	OVERFREQUENCY ALARM: 60.6 Hz	Range: 0.00 to 90.00 Hz Reflects the present voltage frequency value.
ESCAPE MESSAGE	NEUTRAL O/V (FUND) ALARM: 0.0 V	Range: 0.0 to 25000.0 V. The present fundamental neutral voltage value is displayed here.
ESCAPE MESSAGE	NEUTRAL U/V (3rd) ALARM: 0.0 V	Range: 0.0 to 25000.0 V. The present 3rd harmonic neutral voltage value is displayed here.
ESCAPE MESSAGE	REACTIVE POWER Mvar ALARM: +20.000	Range: -2000.000 to +2000.000 Mvar The current Mvar value is shown here
ESCAPE MESSAGE	REVERSE POWER ALARM: -20.000 MW	Range: -2000.000 to +2000.000 MW The current MW value is shown here
ESCAPE MESSAGE	LOW FORWARD POWER ALARM: -20.000 MW	Range: -2000.000 to +2000.000 MW The current MW value is shown here
ESCAPE MESSAGE	STATOR RTD #1 ALARM: 135°C	Range: -50 to +250°C. The present RTD temperature is shown. Reflects programmed RTD Name.
ESCAPE MESSAGE	OPEN SENSOR ALARM: RTD # 1 2 3 4 5 6 ...	Range: RTDs 1 to 12. Reflects the RTD(s) that caused the open sensor alarm.
ESCAPE MESSAGE	SHORT/LOW TEMP ALARM RTD # 7 8 9 10 11 ...	Range: RTDs 1 to 12. Reflects the RTD(s) that caused the short/low temp. alarm.
ESCAPE MESSAGE	THERMAL MODEL ALARM: 100% TC USED	Range: 1 to 100% The thermal capacity used is shown here.
ESCAPE MESSAGE	TRIP COUNTER ALARM: 25 Trips	Range: 1 to 10000 The number of generator trips is shown here.























ESCAPE MESSAGE	BREAKER FAILURE ALARM: Active	Range: Active, Latched. Active if condition that caused the alarm is still present.
ESCAPE MESSAGE	TRIP COIL MONITOR ALARM: Active	Range: Active, Latched. Active if condition that caused the alarm is still present.
ESCAPE MESSAGE	VT FUSE FAILURE ALARM: Active	Range: Active, Latched. Active if condition that caused the alarm is still present.
ESCAPE MESSAGE	CURRENT DEMAND ALARM: 1053 A	Range: 1 to 999999 A. The running current demand is shown here.
ESCAPE MESSAGE	MW DEMAND ALARM: 50.500	Range: -2000.000 to +2000.000 MW Current Running MW Demand is shown here
ESCAPE MESSAGE	Mvar DEMAND ALARM: -20.000	Range: -2000.000 to +2000.000 Mvar Current Running Mvar Demand is shown here
ESCAPE MESSAGE	MVA DEMAND ALARM: 20.000	Range: 0 to 2000.000 MVA Current Running MVA Demand is shown here
ESCAPE MESSAGE	ANALOG I/P 1 ALARM: 201 Units	Range: -50000 to +50000. Reflects the Analog Input 1 Name. The Analog Input level is shown here.
ESCAPE MESSAGE	ANALOG I/P 2 ALARM: 201 Units	Range: -50000 to +50000. Reflects the Analog Input 2 Name. The Analog Input level is shown here.
ESCAPE MESSAGE	ANALOG I/P 3 ALARM: 201 Units	Range: -50000 to +50000. Reflects the Analog Input 3 Name. The Analog Input level is shown here.
ESCAPE MESSAGE	ANALOG I/P 4 ALARM: 201 Units	Range: -50000 to +50000. Reflects the Analog Input 4 Name. The Analog Input level is shown here.
ESCAPE MESSAGE	ALARM, 489 NOT INSERTED PROPERLY	If the 489 chassis is only partially engaged with the case, this service alarm appears after 1 sec. Secure the chassis handle to ensure that all contacts mate properly
ESCAPE MESSAGE	489 NOT IN SERVICE Simulation Mode	Range: Not Programmed, Simulation Mode, Output Relays Forced, Analog Output Forced, Test Switch Shorted
ESCAPE MESSAGE	IRIG-B FAILURE ALARM: Active	Range: Active. Seen only if IRIG-B is enabled and the associated signal input is lost.
ESCAPE MESSAGE	GEN. RUNNING HOURS ALARM: 1000 h	Range: 0 to 1000000 hrs. Seen only if the Running Hour Alarm is enabled.

Any active or latched alarms may be viewed here.

5.2.4 TRIP PICKUPS

<ul style="list-style-type: none"> ■ TRIP PICKUPS ■ [ENTER] for more 	ENTER ESCAPE	Input A PICKUP: Not Enabled	Range: Not Enabled, Inactive, Timing Out, Active Trip, Latched Trip. Reflects Input Name as programmed. Seen only if function assigned is an input.
	ESCAPE MESSAGE	Input B PICKUP: Not Enabled	Range: see Input A PICKUP above
	ESCAPE MESSAGE	Input C PICKUP: Not Enabled	Range: see Input A PICKUP above
	ESCAPE MESSAGE	Input D PICKUP: Not Enabled	Range: see Input A PICKUP above
	ESCAPE MESSAGE	Input E PICKUP: Not Enabled	Range: see Input A PICKUP above

	Input F PICKUP: Not Enabled	Range: see Input A PICKUP above
	Input G PICKUP: Not Enabled	Range: see Input A PICKUP above
	SEQUENTIAL TRIP PICKUP: Not Enabled	Range: Not Enabled, Inactive, Timing Out, Active Trip, Latched Trip. Seen only if function is an input.
	FIELD-BKR DISCREP. PICKUP: Not Enabled	Range: Not Enabled, Inactive, Timing Out, Active Trip, Latched Trip. Seen only if function is an input.
	TACHOMETER PICKUP: Not Enabled	Range: Not Enabled, Inactive, Timing Out, Active Trip, Latched Trip. Seen only if function is an input.
	OFFLINE OVERCURRENT PICKUP: Not Enabled	Range: Not Enabled, Inactive, Timing Out, Active Trip, Latched Trip.
	INADVERTENT ENERG. PICKUP: Not Enabled	Range: Not Enabled, Inactive, Timing Out, Active Trip, Latched Trip.
	PHASE OVERCURRENT PICKUP: Not Enabled	Range: Not Enabled, Inactive, Timing Out, Active Trip, Latched Trip.
	NEG. SEQ. OVERCURRENT PICKUP: Not Enabled	Range: Not Enabled, Inactive, Timing Out, Active Trip, Latched Trip.
	GROUND OVERCURRENT PICKUP: Not Enabled	Range: Not Enabled, Inactive, Timing Out, Active Trip, Latched Trip.
	PHASE DIFFERENTIAL PICKUP: Not Enabled	Range: Not Enabled, Inactive, Timing Out, Active Trip, Latched Trip.
	GROUND DIRECTIONAL PICKUP: Not Enabled	Range: Not Enabled, Inactive, Timing Out, Active Trip, Latched Trip.
	HIGH-SET PHASE O/C PICKUP: Not Enabled	Range: Not Enabled, Inactive, Timing Out, Active Trip, Latched Trip.
	UNDERVOLTAGE PICKUP: Not Enabled	Range: Not Enabled, Inactive, Timing Out, Active Trip, Latched Trip.
	OVERVOLTAGE PICKUP: Not Enabled	Range: Not Enabled, Inactive, Timing Out, Active Trip, Latched Trip.
	VOLTS/HERTZ PICKUP: Not Enabled	Range: Not Enabled, Inactive, Timing Out, Active Trip, Latched Trip.
	PHASE REVERSAL PICKUP: Not Enabled	Range: Not Enabled, Inactive, Timing Out, Active Trip, Latched Trip.
	UNDERFREQUENCY PICKUP: Not Enabled	Range: Not Enabled, Inactive, Timing Out, Active Trip, Latched Trip.
	OVERFREQUENCY PICKUP: Not Enabled	Range: Not Enabled, Inactive, Timing Out, Active Trip, Latched Trip.
	NEUTRAL O/V (FUND) PICKUP: Not Enabled	Range: Not Enabled, Inactive, Timing Out, Active Trip, Latched Trip.
	NEUTRAL U/V (3rd) PICKUP: Not Enabled	Range: Not Enabled, Inactive, Timing Out, Active Trip, Latched Trip.
	LOSS OF EXCITATION 1 PICKUP: Not Enabled	Range: Not Enabled, Inactive, Timing Out, Active Trip, Latched Trip.



















	LOSS OF EXCITATION 2 PICKUP: Not Enabled	Range: Not Enabled, Inactive, Timing Out, Active Trip, Latched Trip.
	DISTANCE ZONE 1 PICKUP: Not Enabled	Range: Not Enabled, Inactive, Timing Out, Active Trip, Latched Trip.
	DISTANCE ZONE 2 PICKUP: Not Enabled	Range: Not Enabled, Inactive, Timing Out, Active Trip, Latched Trip.
	REACTIVE POWER PICKUP: Not Enabled	Range: Not Enabled, Inactive, Timing Out, Active Trip, Latched Trip.
	REVERSE POWER PICKUP: Not Enabled	Range: Not Enabled, Inactive, Timing Out, Active Trip, Latched Trip.
	LOW FORWARD POWER PICKUP: Not Enabled	Range: Not Enabled, Inactive, Timing Out, Active Trip, Latched Trip.
	RTD #1 PICKUP: Not Enabled	Range: Not Enabled, Inactive, Timing Out, Active Trip, Latched Trip.
	RTD #2 PICKUP: Not Enabled	Range: Not Enabled, Inactive, Timing Out, Active Trip, Latched Trip.
	RTD #3 PICKUP: Not Enabled	Range: Not Enabled, Inactive, Timing Out, Active Trip, Latched Trip.
	RTD #4 PICKUP: Not Enabled	Range: Not Enabled, Inactive, Timing Out, Active Trip, Latched Trip.
	RTD #5 PICKUP: Not Enabled	Range: Not Enabled, Inactive, Timing Out, Active Trip, Latched Trip.
	RTD #6 PICKUP: Not Enabled	Range: Not Enabled, Inactive, Timing Out, Active Trip, Latched Trip.
	RTD #7 PICKUP: Not Enabled	Range: Not Enabled, Inactive, Timing Out, Active Trip, Latched Trip.
	RTD #8 PICKUP: Not Enabled	Range: Not Enabled, Inactive, Timing Out, Active Trip, Latched Trip.
	RTD #9 PICKUP: Not Enabled	Range: Not Enabled, Inactive, Timing Out, Active Trip, Latched Trip.
	RTD #10 PICKUP: Not Enabled	Range: Not Enabled, Inactive, Timing Out, Active Trip, Latched Trip.
	RTD #11 PICKUP: Not Enabled	Range: Not Enabled, Inactive, Timing Out, Active Trip, Latched Trip.
	RTD #12 PICKUP: Not Enabled	Range: Not Enabled, Inactive, Timing Out, Active Trip, Latched Trip.
	THERMAL MODEL PICKUP: Not Enabled	Range: Not Enabled, Inactive, Timing Out, Active Trip, Latched Trip.
	ANALOG I/P 1 PICKUP: Not Enabled	Range: Not Enabled, Inactive, Timing Out, Active Trip, Latched Trip. Reflects programmed Analog Input Name. Seen only if input is enabled.
	ANALOG I/P 2 PICKUP: Not Enabled	Range: see ANALOG I/P 1 above
	ANALOG I/P 3 PICKUP: Not Enabled	Range: see ANALOG I/P 1 above



ANALOG I/P 4 *Range: see ANALOG I/P 1 above*
PICKUP: Not Enabled

The trip pickup messages may be very useful during testing. They will indicate if a trip feature has been enabled, if it is inactive (not picked up), timing out (picked up and timing), active trip (still picked up, timed out, and causing a trip), or latched trip (no longer picked up, but had timed out and caused a trip that is latched). These values may also be particularly useful as data transmitted to a master device for monitoring.

5.2.5 ALARM PICKUPS

<ul style="list-style-type: none"> ■ ALARM PICKUPS ■ [ENTER] for more 		Input A PICKUP: Not Enabled	<i>Range: Not Enabled, Inactive, Timing Out, Active Alarm, Latched Alarm. Reflects Input Name as programmed. Seen only if function is an input.</i>
		Input B PICKUP: Not Enabled	<i>Range: see Input A PICKUP</i>
		Input C PICKUP: Not Enabled	<i>Range: see Input A PICKUP</i>
		Input D PICKUP: Not Enabled	<i>Range: see Input A PICKUP</i>
		Input E PICKUP: Not Enabled	<i>Range: see Input A PICKUP</i>
		Input F PICKUP: Not Enabled	<i>Range: see Input A PICKUP</i>
		Input G PICKUP: Not Enabled	<i>Range: see Input A PICKUP</i>
		Input G ALARM STATUS: Active	<i>Range: see Input A PICKUP</i>
		TACHOMETER PICKUP: Not Enabled	<i>Range: Not Enabled, Inactive, Timing Out, Active Alarm, Latched Alarm. Seen only if function is an input.</i>
		OVERCURRENT PICKUP: Not Enabled	<i>Range: Not Enabled, Inactive, Timing Out, Active Alarm, Latched Alarm.</i>
		NEG. SEQ. OVERCURRENT PICKUP: Not Enabled	<i>Range: Not Enabled, Inactive, Timing Out, Active Alarm, Latched Alarm.</i>
		GROUND OVERCURRENT PICKUP: Not Enabled	<i>Range: Not Enabled, Inactive, Timing Out, Active Alarm, Latched Alarm.</i>
		PHASE DIFFERENTIAL PICKUP: Not Enabled	<i>Range: Not Enabled, Inactive, Timing Out, Active Alarm, Latched Alarm.</i>
		GROUND DIRECTIONAL PICKUP: Not Enabled	<i>Range: Not Enabled, Inactive, Timing Out, Active Alarm, Latched Alarm.</i>
		UNDERVOLTAGE PICKUP: Not Enabled	<i>Range: Not Enabled, Inactive, Timing Out, Active Alarm, Latched Alarm.</i>
		OVERVOLTAGE PICKUP: Not Enabled	<i>Range: Not Enabled, Inactive, Timing Out, Active Alarm, Latched Alarm.</i>
		VOLTS/HERTZ PICKUP: Not Enabled	<i>Range: Not Enabled, Inactive, Timing Out, Active Alarm, Latched Alarm.</i>
	UNDERFREQUENCY PICKUP: Not Enabled	<i>Range: Not Enabled, Inactive, Timing Out, Active Alarm, Latched Alarm.</i>	

	OVERFREQUENCY PICKUP: Not Enabled	Range: Not Enabled, Inactive, Timing Out, Active Alarm, Latched Alarm.
	NEUTRAL O/V (FUND) PICKUP: Not Enabled	Range: Not Enabled, Inactive, Timing Out, Active Alarm, Latched Alarm.
	NEUTRAL U/V (3rd) PICKUP: Not Enabled	Range: Not Enabled, Inactive, Timing Out, Active Alarm, Latched Alarm.
	REACTIVE POWER PICKUP: Not Enabled	Range: Not Enabled, Inactive, Timing Out, Active Alarm, Latched Alarm.
	REVERSE POWER PICKUP: Not Enabled	Range: Not Enabled, Inactive, Timing Out, Active Alarm, Latched Alarm.
	LOW FORWARD POWER PICKUP: Not Enabled	Range: Not Enabled, Inactive, Timing Out, Active Alarm, Latched Alarm.
	RTD #1 PICKUP: Not Enabled	Range: Not Enabled, Inactive, Timing Out, Active Alarm, Latched Alarm.
	RTD #2 PICKUP: Not Enabled	Range: Not Enabled, Inactive, Timing Out, Active Alarm, Latched Alarm.
	RTD #3 PICKUP: Not Enabled	Range: Not Enabled, Inactive, Timing Out, Active Alarm, Latched Alarm.
	RTD #4 PICKUP: Not Enabled	Range: Not Enabled, Inactive, Timing Out, Active Alarm, Latched Alarm.
	RTD #5 PICKUP: Not Enabled	Range: Not Enabled, Inactive, Timing Out, Active Alarm, Latched Alarm.
	RTD #6 PICKUP: Not Enabled	Range: Not Enabled, Inactive, Timing Out, Active Alarm, Latched Alarm.
	RTD #7 PICKUP: Not Enabled	Range: Not Enabled, Inactive, Timing Out, Active Alarm, Latched Alarm.
	RTD #8 PICKUP: Not Enabled	Range: Not Enabled, Inactive, Timing Out, Active Alarm, Latched Alarm.
	RTD #9 PICKUP: Not Enabled	Range: Not Enabled, Inactive, Timing Out, Active Alarm, Latched Alarm.
	RTD #10 PICKUP: Not Enabled	Range: Not Enabled, Inactive, Timing Out, Active Alarm, Latched Alarm.
	RTD #11 PICKUP: Not Enabled	Range: Not Enabled, Inactive, Timing Out, Active Alarm, Latched Alarm.
	RTD #12 PICKUP: Not Enabled	Range: Not Enabled, Inactive, Timing Out, Active Alarm, Latched Alarm.
	OPEN SENSOR PICKUP: Not Enabled	Range: Not Enabled, Inactive, Timing Out, Active Alarm, Latched Alarm.
	SHORT/LOW TEMP PICKUP: Not Enabled	Range: Not Enabled, Inactive, Timing Out, Active Alarm, Latched Alarm.
	THERMAL MODEL PICKUP: Not Enabled	Range: Not Enabled, Inactive, Timing Out, Active Alarm, Latched Alarm.
	TRIP COUNTER PICKUP: Not Enabled	Range: Not Enabled, Inactive, Timing Out, Active Alarm, Latched Alarm.

ESCAPE MESSAGE	BREAKER FAILURE PICKUP: Not Enabled	Range: Not Enabled, Inactive, Timing Out, Active Alarm, Latched Alarm.
ESCAPE MESSAGE	TRIP COIL MONITOR PICKUP: Not Enabled	Range: Not Enabled, Inactive, Timing Out, Active Alarm, Latched Alarm.
ESCAPE MESSAGE	VT FUSE FAILURE PICKUP: Not Enabled	Range: Not Enabled, Inactive, Timing Out, Active Alarm, Latched Alarm.
ESCAPE MESSAGE	CURRENT DEMAND PICKUP: Not Enabled	Range: Not Enabled, Inactive, Timing Out, Active Alarm, Latched Alarm.
ESCAPE MESSAGE	MW DEMAND PICKUP: Not Enabled	Range: Not Enabled, Inactive, Timing Out, Active Alarm, Latched Alarm.
ESCAPE MESSAGE	Mvar DEMAND PICKUP: Not Enabled	Range: Not Enabled, Inactive, Timing Out, Active Alarm, Latched Alarm.
ESCAPE MESSAGE	MVA DEMAND PICKUP: Not Enabled	Range: Not Enabled, Inactive, Timing Out, Active Alarm, Latched Alarm.
ESCAPE MESSAGE	ANALOG I/P 1 PICKUP: Not Enabled	Range: Not Enabled, Inactive, Timing Out, Active Alarm, Latched Alarm. Reflects programmed Analog Input Name. Seen only if input is enabled.
ESCAPE MESSAGE	ANALOG I/P 2 PICKUP: Not Enabled	Range: see ANALOG I/P 1 PICKUP
ESCAPE MESSAGE	ANALOG I/P 3 PICKUP: Not Enabled	Range: see ANALOG I/P 1 PICKUP
ESCAPE MESSAGE	ANALOG I/P 4 PICKUP: Not Enabled	Range: see ANALOG I/P 1 PICKUP

The alarm pickup messages may be very useful during testing. They will indicate if a alarm feature has been enabled, if it is inactive (not picked up), timing out (picked up and timing), active alarm (still picked up, timed out, and causing an alarm), or latched alarm (no longer picked up, but had timed out and caused a alarm that is latched). These values may also be particularly useful as data transmitted to a master device for monitoring.

5.2.6 DIGITAL INPUTS

<ul style="list-style-type: none"> ■ DIGITAL INPUTS ■ [ENTER] for more 	[ENTER] → [ESCAPE] ←	ACCESS SWITCH STATE: Open	Range: Open, Shorted
	[ESCAPE] ↻ MESSAGE ⇅	BREAKER STATUS SWITCH STATE: Open	Range: Open, Shorted
	[ESCAPE] ↻ MESSAGE ⇅	ASSIGNABLE DIGITAL INPUT1 STATE: Open	Range: Open, Shorted
	[ESCAPE] ↻ MESSAGE ⇅	ASSIGNABLE DIGITAL INPUT2 STATE: Open	Range: Open, Shorted
	[ESCAPE] ↻ MESSAGE ⇅	ASSIGNABLE DIGITAL INPUT3 STATE: Open	Range: Open, Shorted
	[ESCAPE] ↻ MESSAGE ⇅	ASSIGNABLE DIGITAL INPUT4 STATE: Open	Range: Open, Shorted
	[ESCAPE] ↻ MESSAGE ⇅	ASSIGNABLE DIGITAL INPUT5 STATE: Open	Range: Open, Shorted
	[ESCAPE] ↻ MESSAGE ⇅	ASSIGNABLE DIGITAL INPUT6 STATE: Open	Range: Open, Shorted
	[ESCAPE] ↻ MESSAGE ⇅	ASSIGNABLE DIGITAL INPUT7 STATE: Open	Range: Open, Shorted
	[ESCAPE] ↻ MESSAGE ↑	TRIP COIL SUPERVISION: No Coil	Range: Open, Shorted

The messages shown here may be used to monitor digital input status. This may be useful during relay testing or during installation.

5.2.7 REAL TIME CLOCK

<ul style="list-style-type: none"> ■ REAL TIME CLOCK ■ [ENTER] for more 	[ENTER] → [ESCAPE] ←	DATE: 01/01/1995 TIME: 12:00:00	Range: 01/01/1995 to 12/31/2094, 00:00:00 to 23:59:59
---	-------------------------	------------------------------------	---

The time and date from the 489 real time clock may be viewed here.

5.3.1 CURRENT METERING

■ CURRENT METERING ■ [ENTER] for more		[ENTER]	A: 0 B: 0	Range: 0 to 999999 A
		[ESCAPE]	C: 0 Amps	
		[ESCAPE]	a: 0 b: 0	Range: 0 to 999999 A
		[MESSAGE]	c: 0 Neut. Amps	
		[ESCAPE]	a: 0 b: 0	Range: 0 to 999999 A
		[MESSAGE]	c: 0 Diff. Amps	
		[ESCAPE]	AVERAGE PHASE	Range: 0 to 999999 A
		[MESSAGE]	CURRENT: 0 Amps	
		[ESCAPE]	GENERATOR LOAD:	Range: 0 to 2000% FLA
		[MESSAGE]	0% FLA	
		[ESCAPE]	NEGATIVE SEQUENCE	Range: 0 to 2000% FLA
		[MESSAGE]	CURRENT: 0% FLA	
		[ESCAPE]	PHASE A CURRENT:	Range: 0 to 999999 A, 0 to 359°
		[MESSAGE]	0 A 0° Lag	
		[ESCAPE]	PHASE B CURRENT:	Range: 0 to 999999 A, 0 to 359°
		[MESSAGE]	0 A 0° Lag	
		[ESCAPE]	PHASE C CURRENT:	Range: 0 to 999999 A, 0 to 359°
		[MESSAGE]	0 A 0° Lag	
		[ESCAPE]	NEUT. END A CURRENT:	Range: 0 to 999999 A, 0 to 359°
		[MESSAGE]	0 A 0° Lag	
		[ESCAPE]	NEUT. END B CURRENT:	Range: 0 to 999999 A, 0 to 359°
		[MESSAGE]	0 A 0° Lag	
		[ESCAPE]	NEUT. END C CURRENT:	Range: 0 to 999999 A, 0 to 359°
		[MESSAGE]	0 A 0° Lag	
		[ESCAPE]	DIFF. A CURRENT:	Range: 0 to 999999 A, 0 to 359°
		[MESSAGE]	0 A 0° Lag	
		[ESCAPE]	DIFF. B CURRENT:	Range: 0 to 999999 A, 0 to 359°
		[MESSAGE]	0 A 0° Lag	
		[ESCAPE]	DIFF. C CURRENT:	Range: 0 to 999999 A, 0 to 359°
		[MESSAGE]	0 A 0° Lag	
		[ESCAPE]	GROUND CURRENT:	Range: 0.0 to 200000.0 A, 0 to 359°
		[MESSAGE]	0.0 A 0° Lag	Seen only if 1 A Ground CT input is used
		[ESCAPE]	GROUND CURRENT:	Range: 0.00 to 100.00 A, 0 to 359°
		[MESSAGE]	0.00 A 0° Lag	Seen only if 50:0.025 Ground CT is used

All measured current values are displayed here. **A, B, C AMPS** represent the output side CT measurements: **A, B, C NEUT. AMPS** the neutral end CT measurements, and **A, B, C DIFF. AMPS** the differential operating current calculated as the vector difference between the output side and the neutral end CT measurements on a per phase basis. The 489 negative-sequence current is defined as the ratio of negative-sequence current to generator rated FLA, $I_2 / FLA \times 100\%$. The generator full load amps is calculated as: generator rated MVA / ($\sqrt{3} \times$ generator phase-phase voltage). Polar coordinates for measured currents are also shown using V_a (wye connection) or V_{ab} (open delta connection) as a zero angle reference vector. In the absence of a voltage signal (V_a or V_{ab}), the IA output current is used as the zero angle reference vector.

5.3.2 VOLTAGE METERING

■ VOLTAGE METERING
 ■ [ENTER] for more

ENTER →	Vab: 0 Vbc: 0 Vca: 0 Volts	Range: 0 to 50000 V. Not seen if VT CONNECTION is programmed as None.
← ESCAPE	AVERAGE LINE VOLTAGE: 0 Volts	Range: 0 to 50000 V. Not seen if VT CONNECTION is programmed as None.
MESSAGE ↕		
← ESCAPE	Van: 0 Vbn: 0 Vcn: 0 Volts	Range: 0 to 50000 V. Seen only if VT CONNECTION is programmed as Wye.
MESSAGE ↕		
← ESCAPE	AVERAGE PHASE VOLTAGE: 0 Volts	Range: 0 to 50000 V. Seen only if VT CONNECTION is programmed as Wye.
MESSAGE ↕		
← ESCAPE	LINE A-B VOLTAGE: 0 V 0° Lag	Range: 0 to 50000 V, 0 to 359°. Not seen if VT CONNECTION is programmed as None.
MESSAGE ↕		
← ESCAPE	LINE B-C VOLTAGE: 0 V 0° Lag	Range: 0 to 50000 V, 0 to 359°. Not seen if VT CONNECTION is programmed as None.
MESSAGE ↕		
← ESCAPE	LINE C-A VOLTAGE: 0 V 0° Lag	Range: 0 to 50000 V, 0 to 359°. Not seen if VT CONNECTION is programmed as None.
MESSAGE ↕		
← ESCAPE	PHASE A-N VOLTAGE: 0 V 0° Lag	Range: 0 to 50000 V, 0 to 359°. Seen only if VT CONNECTION is programmed as Wye.
MESSAGE ↕		
← ESCAPE	PHASE B-N VOLTAGE: 0 V 0° Lag	Range: 0 to 50000 V, 0 to 359°. Seen only if VT CONNECTION is programmed as Wye.
MESSAGE ↕		
← ESCAPE	PHASE C-N VOLTAGE: 0 V 0° Lag	Range: 0 to 50000 V, 0 to 359°. Seen only if VT CONNECTION is programmed as Wye.
MESSAGE ↕		
← ESCAPE	PER UNIT MEASUREMENT OF V/Hz: 0.00	Range: 0.00 to 2.00. Not seen if VT CONNECTION is programmed as None.
MESSAGE ↕		
← ESCAPE	FREQUENCY: 0.00 Hz	Range: 0.00 to 90.00 Hz. Not seen if VT CONNECTION is programmed as None.
MESSAGE ↕		
← ESCAPE	NEUTRAL VOLTAGE FUND: 0.0 V	Range: 0.0 to 25000.0 V. Seen only if there is a neutral voltage transformer.
MESSAGE ↕		
← ESCAPE	NEUTRAL VOLTAGE 3rd HARM: 0.0 V	Range: 0.0 to 25000.0 V. Seen only if there is a neutral voltage transformer.
MESSAGE ↕		
← ESCAPE	TERMINAL VOLTAGE 3rd HARM: 0.0 V	Range: 0.0 to 25000.0 V. Seen only if VT CONNECTION is programmed as Wye.
MESSAGE ↕		
← ESCAPE	IMPEDANCE Vab / Iab 0.0 Ω sec. 0°	Range: 0.0 to 6553.5 Ωsec., 0 to 359°
MESSAGE ↕		



Measured voltage parameters will be displayed here. The V/Hz measurement is a per unit value based on Vab voltage/ measured frequency divided by VT nominal/nominal system frequency. Polar coordinates for measured phase and/or line voltages are also shown using Va (wye connection) or Vab (open delta connection) as a zero angle reference vector. In the absence of a voltage signal (Va or Vab), IA output current is used as the zero angle reference vector.

If VT CONNECTION TYPE is programmed as "None" and NEUTRAL VOLTAGE TRANSFORMER is "No" in S2 SYSTEM, the following flash message will appear when an attempt is made to enter this group of messages.

THIS FEATURE
 NOT PROGRAMMED

5.3.3 POWER METERING

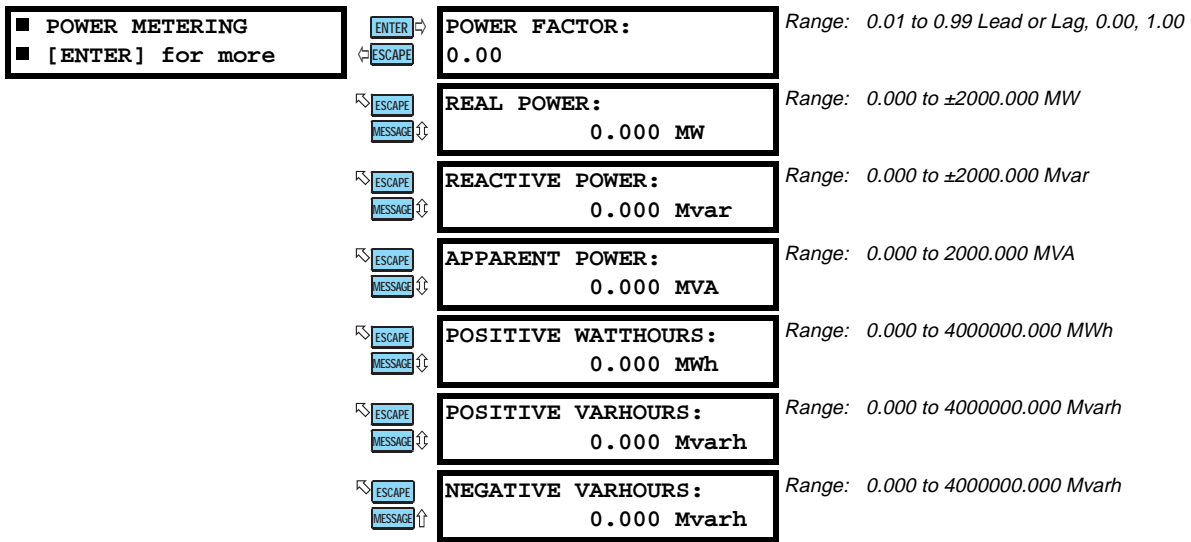

The values for power metering appear here. Three-phase total power quantities are displayed here. Watthours and var-hours are also shown here. Watthours and varhours will not update if a digital input programmed as Test Input is shorted.

5



An induction generator, by convention generates Watts and consumes vars (+Watts and -vars). A synchronous generator can also generate vars (+vars).

If the VT CONNECTION TYPE is programmed as "None", the THIS FEATURE NOT PROGRAMMED flash message will appear when an attempt is made to enter this group of messages.

5.3.4 TEMPERATURE

<ul style="list-style-type: none"> ■ TEMPERATURE ■ [ENTER] for more 	<div style="border: 1px solid black; padding: 2px; margin-bottom: 2px;"> ENTER → </div> <div style="border: 1px solid black; padding: 2px;"> ← ESCAPE </div>	<div style="border: 1px solid black; padding: 2px; margin-bottom: 2px;"> HOTTEST STATOR RTD RTD#1: 40°C </div>	Range: -50 to 250°C, No RTD Seen only if at least 1 RTD programmed as Stator
	<div style="border: 1px solid black; padding: 2px; margin-bottom: 2px;"> ↶ ESCAPE </div> <div style="border: 1px solid black; padding: 2px;"> MESSAGE ⇅ </div>	<div style="border: 1px solid black; padding: 2px; margin-bottom: 2px;"> RTD #1 TEMPERATURE: 40°C </div>	Range: -50 to 250°C, No RTD. Not seen if RTD programmed as None. Value reflects the RTD Name as programmed
	<div style="border: 1px solid black; padding: 2px; margin-bottom: 2px;"> ↶ ESCAPE </div> <div style="border: 1px solid black; padding: 2px;"> MESSAGE ⇅ </div>	<div style="border: 1px solid black; padding: 2px; margin-bottom: 2px;"> RTD #2 TEMPERATURE: 40°C </div>	Range: see RTD #1 TEMPERATURE above
	<div style="border: 1px solid black; padding: 2px; margin-bottom: 2px;"> ↶ ESCAPE </div> <div style="border: 1px solid black; padding: 2px;"> MESSAGE ⇅ </div>	<div style="border: 1px solid black; padding: 2px; margin-bottom: 2px;"> RTD #3 TEMPERATURE: 40°C </div>	Range: see RTD #1 TEMPERATURE above
	<div style="border: 1px solid black; padding: 2px; margin-bottom: 2px;"> ↶ ESCAPE </div> <div style="border: 1px solid black; padding: 2px;"> MESSAGE ⇅ </div>	<div style="border: 1px solid black; padding: 2px; margin-bottom: 2px;"> RTD #4 TEMPERATURE: 40°C </div>	Range: see RTD #1 TEMPERATURE above
	<div style="border: 1px solid black; padding: 2px; margin-bottom: 2px;"> ↶ ESCAPE </div> <div style="border: 1px solid black; padding: 2px;"> MESSAGE ⇅ </div>	<div style="border: 1px solid black; padding: 2px; margin-bottom: 2px;"> RTD #5 TEMPERATURE: 40°C </div>	Range: see RTD #1 TEMPERATURE above
	<div style="border: 1px solid black; padding: 2px; margin-bottom: 2px;"> ↶ ESCAPE </div> <div style="border: 1px solid black; padding: 2px;"> MESSAGE ⇅ </div>	<div style="border: 1px solid black; padding: 2px; margin-bottom: 2px;"> RTD #6 TEMPERATURE: 40°C </div>	Range: see RTD #1 TEMPERATURE above
	<div style="border: 1px solid black; padding: 2px; margin-bottom: 2px;"> ↶ ESCAPE </div> <div style="border: 1px solid black; padding: 2px;"> MESSAGE ⇅ </div>	<div style="border: 1px solid black; padding: 2px; margin-bottom: 2px;"> RTD #7 TEMPERATURE: 40°C </div>	Range: see RTD #1 TEMPERATURE above
	<div style="border: 1px solid black; padding: 2px; margin-bottom: 2px;"> ↶ ESCAPE </div> <div style="border: 1px solid black; padding: 2px;"> MESSAGE ⇅ </div>	<div style="border: 1px solid black; padding: 2px; margin-bottom: 2px;"> RTD #8 TEMPERATURE: 40°C </div>	Range: see RTD #1 TEMPERATURE above
	<div style="border: 1px solid black; padding: 2px; margin-bottom: 2px;"> ↶ ESCAPE </div> <div style="border: 1px solid black; padding: 2px;"> MESSAGE ⇅ </div>	<div style="border: 1px solid black; padding: 2px; margin-bottom: 2px;"> RTD #9 TEMPERATURE: 40°C </div>	Range: see RTD #1 TEMPERATURE above
	<div style="border: 1px solid black; padding: 2px; margin-bottom: 2px;"> ↶ ESCAPE </div> <div style="border: 1px solid black; padding: 2px;"> MESSAGE ⇅ </div>	<div style="border: 1px solid black; padding: 2px; margin-bottom: 2px;"> RTD #10 TEMPERATURE: 40°C </div>	Range: see RTD #1 TEMPERATURE above
	<div style="border: 1px solid black; padding: 2px; margin-bottom: 2px;"> ↶ ESCAPE </div> <div style="border: 1px solid black; padding: 2px;"> MESSAGE ⇅ </div>	<div style="border: 1px solid black; padding: 2px; margin-bottom: 2px;"> RTD #11 TEMPERATURE: 40°C </div>	Range: see RTD #1 TEMPERATURE above
	<div style="border: 1px solid black; padding: 2px; margin-bottom: 2px;"> ↶ ESCAPE </div> <div style="border: 1px solid black; padding: 2px;"> MESSAGE ⇅ </div>	<div style="border: 1px solid black; padding: 2px; margin-bottom: 2px;"> RTD #12 TEMPERATURE: 40°C </div>	Range: see RTD #1 TEMPERATURE above

The current level of the 12 RTDs will be displayed here. If the RTD is not connected, the value will be "No RTD". If no RTDs are programmed in the S7 RTD TEMPERATURE setpoints menu, the THIS FEATURE NOT PROGRAMMED flash message will appear when an attempt is made to enter this group of messages.

5.3.5 DEMAND METERING

<ul style="list-style-type: none"> ■ DEMAND METERING ■ [ENTER] for more 	<div style="border: 1px solid black; padding: 2px; display: inline-block;">ENTER</div>	<div style="border: 1px solid black; padding: 2px;">CURRENT</div>	Range: 0 to 999999 A
	<div style="border: 1px solid black; padding: 2px; display: inline-block;">←ESCAPE</div>	<div style="border: 1px solid black; padding: 2px;">DEMAND: 0 Amps</div>	
	<div style="border: 1px solid black; padding: 2px; display: inline-block;">↻ESCAPE</div>	<div style="border: 1px solid black; padding: 2px;">MW DEMAND:</div>	Range: 0.000 to 2000.000 MW. Not seen if VT CONNECTION TYPE is programmed as None
	<div style="border: 1px solid black; padding: 2px; display: inline-block;">MESSAGE</div>	<div style="border: 1px solid black; padding: 2px;">0.000 MW</div>	
	<div style="border: 1px solid black; padding: 2px; display: inline-block;">↻ESCAPE</div>	<div style="border: 1px solid black; padding: 2px;">Mvar DEMAND:</div>	Range: 0.000 to 2000.000 Mvar. Not seen if VT CONNECTION TYPE is programmed as None
	<div style="border: 1px solid black; padding: 2px; display: inline-block;">MESSAGE</div>	<div style="border: 1px solid black; padding: 2px;">0.000 Mvar</div>	
	<div style="border: 1px solid black; padding: 2px; display: inline-block;">↻ESCAPE</div>	<div style="border: 1px solid black; padding: 2px;">MVA DEMAND:</div>	Range: 0.000 to 2000.000 MVA. Not seen if VT CONNECTION TYPE is programmed as None
	<div style="border: 1px solid black; padding: 2px; display: inline-block;">MESSAGE</div>	<div style="border: 1px solid black; padding: 2px;">0.000 MVA</div>	
	<div style="border: 1px solid black; padding: 2px; display: inline-block;">↻ESCAPE</div>	<div style="border: 1px solid black; padding: 2px;">PEAK CURRENT</div>	Range: 0 to 999999 A
	<div style="border: 1px solid black; padding: 2px; display: inline-block;">MESSAGE</div>	<div style="border: 1px solid black; padding: 2px;">DEMAND: 0 Amps</div>	
	<div style="border: 1px solid black; padding: 2px; display: inline-block;">↻ESCAPE</div>	<div style="border: 1px solid black; padding: 2px;">PEAK MW DEMAND:</div>	Range: 0.000 to 2000.000 MW. Not seen if VT CONNECTION TYPE is programmed as None
	<div style="border: 1px solid black; padding: 2px; display: inline-block;">MESSAGE</div>	<div style="border: 1px solid black; padding: 2px;">0.000 MW</div>	
	<div style="border: 1px solid black; padding: 2px; display: inline-block;">↻ESCAPE</div>	<div style="border: 1px solid black; padding: 2px;">PEAK Mvar DEMAND:</div>	Range: 0.000 to 2000.000 Mvar. Not seen if VT CONNECTION TYPE is programmed as None
	<div style="border: 1px solid black; padding: 2px; display: inline-block;">MESSAGE</div>	<div style="border: 1px solid black; padding: 2px;">0.000 Mvar</div>	
	<div style="border: 1px solid black; padding: 2px; display: inline-block;">↻ESCAPE</div>	<div style="border: 1px solid black; padding: 2px;">PEAK MVA DEMAND:</div>	Range: 0.000 to 2000.000 MVA. Not seen if VT CONNECTION TYPE is programmed as None
	<div style="border: 1px solid black; padding: 2px; display: inline-block;">MESSAGE</div>	<div style="border: 1px solid black; padding: 2px;">0.000 MVA</div>	

The values for current and power demand are shown here. This peak demand information can be cleared using the **S1 489 SETUP \ CLEAR DATA \ CLEAR PEAK DEMAND** setpoint. Demand is shown only for positive real and positive reactive power (+Watts, +vars). Peak demand will not update if a digital input programmed as Test Input is shorted.

5.3.6 ANALOG INPUTS

<ul style="list-style-type: none"> ■ ANALOG INPUTS ■ [ENTER] for more 	<div style="border: 1px solid black; padding: 2px; display: inline-block;">ENTER</div>	<div style="border: 1px solid black; padding: 2px;">ANALOG I/P 1</div>	Range: -50000 to 50000. Message seen only if Analog Input is programmed. Message reflects Analog Input Name as programmed.
	<div style="border: 1px solid black; padding: 2px; display: inline-block;">←ESCAPE</div>	<div style="border: 1px solid black; padding: 2px;">0 Units</div>	
	<div style="border: 1px solid black; padding: 2px; display: inline-block;">↻ESCAPE</div>	<div style="border: 1px solid black; padding: 2px;">ANALOG I/P 2</div>	Range: as for ANALOG I/P 1 above
	<div style="border: 1px solid black; padding: 2px; display: inline-block;">MESSAGE</div>	<div style="border: 1px solid black; padding: 2px;">0 Units</div>	
	<div style="border: 1px solid black; padding: 2px; display: inline-block;">↻ESCAPE</div>	<div style="border: 1px solid black; padding: 2px;">ANALOG I/P 3</div>	Range: as for ANALOG I/P 1 above
	<div style="border: 1px solid black; padding: 2px; display: inline-block;">MESSAGE</div>	<div style="border: 1px solid black; padding: 2px;">0 Units</div>	
	<div style="border: 1px solid black; padding: 2px; display: inline-block;">↻ESCAPE</div>	<div style="border: 1px solid black; padding: 2px;">ANALOG I/P 4</div>	Range: as for ANALOG I/P 1 above
	<div style="border: 1px solid black; padding: 2px; display: inline-block;">MESSAGE</div>	<div style="border: 1px solid black; padding: 2px;">0 Units</div>	

The values for analog inputs are shown here. The name of the input and the units will reflect those programmed for each input. If no analog inputs are programmed in the **S11 ANALOG I/O** setpoints page, the **THIS FEATURE NOT PROGRAMMED** flash message will appear when an attempt is made to enter this group of messages.

5.3.7 SPEED

<ul style="list-style-type: none"> ■ SPEED ■ [ENTER] for more 	<div style="border: 1px solid black; padding: 2px; display: inline-block;">ENTER</div>	<div style="border: 1px solid black; padding: 2px;">TACHOMETER: 0 RPM</div>	Range: 0 to 7200 RPM. Seen only if a digital input is configured as Tachometer.
	<div style="border: 1px solid black; padding: 2px; display: inline-block;">←ESCAPE</div>		

If the Tachometer function is assigned to one of the digital inputs, the tachometer readout may be viewed here. A bar graph on the second line of this message represents speed from 0 RPM to rated speed.

If no digital input is configured for tachometer in the **S3 DIGITAL INPUTS** setpoints page, the **THIS FEATURE NOT PROGRAMMED** flash message will appear when an attempt is made to enter this group of messages.

5.4.1 PARAMETER AVERAGES

<ul style="list-style-type: none"> ■ PARAMETER AVERAGES ■ [ENTER] for more 	ENTER →	AVERAGE GENERATOR	Range: 0 to 2000% FLA
	← ESCAPE	LOAD: 100% FLA	
	↖ ESCAPE MESSAGE ⇅	AVERAGE NEG. SEQ. CURRENT: 0% FLA	Range: 0 to 2000% FLA
	↖ ESCAPE MESSAGE ⇅	AVERAGE PHASE-PHASE VOLTAGE: 0 V	Range: 0 to 50000 V. Not seen if VT CONNECTION is programmed as None

The 489 calculates the average magnitude of several parameters over a period of time. This time is specified by **S1 489 SETUP \ PREFERENCES \ PARAMETER AVERAGES CALC PERIOD** setpoint (default 15 minutes). The calculation is a sliding window and is ignored when the generator is offline (that is, the value that was calculated just prior to going offline will be held until the generator is brought back online and a new calculation is made). Parameter averages will not update if a digital input programmed as Test Input is shorted.

5.4.2 RTD MAXIMUMS

<ul style="list-style-type: none"> ■ RTD MAXIMUMS ■ [ENTER] for more 	ENTER →	RTD #1	Range: -50 to 250°C. Not seen if RTD programmed as None. The first line of this message reflects the RTD Name as programmed.
	← ESCAPE	MAX. TEMP.: 40°C	
	↖ ESCAPE MESSAGE ⇅	RTD #2	Range: as for RTD #1 above
	↖ ESCAPE MESSAGE ⇅	MAX. TEMP.: 40°C	
	↖ ESCAPE MESSAGE ⇅	RTD #3	Range: as for RTD #1 above
	↖ ESCAPE MESSAGE ⇅	MAX. TEMP.: 40°C	
	↖ ESCAPE MESSAGE ⇅	RTD #4	Range: as for RTD #1 above
	↖ ESCAPE MESSAGE ⇅	MAX. TEMP.: 40°C	
	↖ ESCAPE MESSAGE ⇅	RTD #5	Range: as for RTD #1 above
	↖ ESCAPE MESSAGE ⇅	MAX. TEMP.: 40°C	
	↖ ESCAPE MESSAGE ⇅	RTD #6	Range: as for RTD #1 above
	↖ ESCAPE MESSAGE ⇅	MAX. TEMP.: 40°C	
↖ ESCAPE MESSAGE ⇅	RTD #7	Range: as for RTD #1 above	
↖ ESCAPE MESSAGE ⇅	MAX. TEMP.: 40°C		
↖ ESCAPE MESSAGE ⇅	RTD #8	Range: as for RTD #1 above	
↖ ESCAPE MESSAGE ⇅	MAX. TEMP.: 40°C		
↖ ESCAPE MESSAGE ⇅	RTD #9	Range: as for RTD #1 above	
↖ ESCAPE MESSAGE ⇅	MAX. TEMP.: 40°C		
↖ ESCAPE MESSAGE ⇅	RTD #10	Range: as for RTD #1 above	
↖ ESCAPE MESSAGE ⇅	MAX. TEMP.: 40°C		
↖ ESCAPE MESSAGE ⇅	RTD #11	Range: as for RTD #1 above	
↖ ESCAPE MESSAGE ⇅	MAX. TEMP.: 40°C		
↖ ESCAPE MESSAGE ⇅	RTD #12	Range: as for RTD #1 above	
↖ ESCAPE MESSAGE ⇅	MAX. TEMP.: 40°C		

The 489 will learn the maximum temperature for each RTD. This information can be cleared using the **S1 489 SETUP \ CLEAR DATA \ CLEAR RTD MAXIMUMS** setpoint. The RTD maximums will not update if a digital input programmed as Test Input is shorted. If no RTDs are programmed in the **S7 RTD TEMPERATURE** setpoints page, the **THIS FEATURE NOT PROGRAMMED** flash message will appear when an attempt is made to enter this group of messages.

5.4.3 ANALOG IN MIN/MAX

<ul style="list-style-type: none"> ■ ANALOG IN MIN/MAX ■ [ENTER] for more 	ENTER →	ANALOG I/P 1	Range: -50000 to 50000. Not seen if Analog Input is programmed as None. Message reflects Analog Input Name as programmed.
	← ESCAPE	MIN: 0 Units	
	↵ ESCAPE	ANALOG I/P 1	Range: as for ANALOG I/P 1 MIN above
	MESSAGE ↕	MAX: 0 Units	
	↵ ESCAPE	ANALOG I/P 2	Range: as for ANALOG I/P 1 MIN above
	MESSAGE ↕	MIN: 0 Units	
	↵ ESCAPE	ANALOG I/P 2	Range: as for ANALOG I/P 1 MIN above
	MESSAGE ↕	MAX: 0 Units	
↵ ESCAPE	ANALOG I/P 3	Range: as for ANALOG I/P 1 MIN above	
MESSAGE ↕	MIN: 0 Units		
↵ ESCAPE	ANALOG I/P 3	Range: as for ANALOG I/P 1 MIN above	
MESSAGE ↕	MAX: 0 Units		
↵ ESCAPE	ANALOG I/P 4	Range: as for ANALOG I/P 1 MIN above	
MESSAGE ↕	MIN: 0 Units		
↵ ESCAPE	ANALOG I/P 4	Range: as for ANALOG I/P 1 MIN above	
MESSAGE ↕	MAX: 0 Units		

5

The 489 learns the minimum and maximum values of the analog inputs since they were last cleared. This information can be cleared using the **S1 489 SETUP \ CLEAR DATA \ CLEAR ANALOG I/P MIN/MAX** setpoint. When the data is cleared, the present value of each analog input will be loaded as a starting point for both minimum and maximum. The name of the input and the units will reflect those programmed for each input. Analog Input minimums and maximums will not update if a digital input programmed as Test Input is shorted.

If no Analog Inputs are programmed in the **S11 ANALOG I/O** setpoints menu, the **THIS FEATURE NOT PROGRAMMED** flash message will appear when an attempt is made to enter this group of messages.

5.5.1 TRIP COUNTERS

- TRIP COUNTERS
- [ENTER] for more

ENTER →	← ESCAPE	TOTAL NUMBER OF TRIPS: 0	Range: 0 to 50000
↶ ESCAPE	MESSAGE ↷	DIGITAL INPUT TRIPS: 0	Range: 0 to 50000 Caused by the General Input Trip feature
↶ ESCAPE	MESSAGE ↷	SEQUENTIAL TRIPS: 0	Range: 0 to 50000
↶ ESCAPE	MESSAGE ↷	FIELD-BKR DISCREP. TRIPS: 0	Range: 0 to 50000
↶ ESCAPE	MESSAGE ↷	TACHOMETER TRIPS: 0	Range: 0 to 50000
↶ ESCAPE	MESSAGE ↷	OFFLINE OVERCURRENT TRIPS: 0	Range: 0 to 50000
↶ ESCAPE	MESSAGE ↷	PHASE OVERCURRENT TRIPS: 0	Range: 0 to 50000
↶ ESCAPE	MESSAGE ↷	NEG. SEQ. OVERCURRENT TRIPS: 0	Range: 0 to 50000
↶ ESCAPE	MESSAGE ↷	GROUND OVERCURRENT TRIPS: 0	Range: 0 to 50000
↶ ESCAPE	MESSAGE ↷	PHASE DIFFERENTIAL TRIPS: 0	Range: 0 to 50000
↶ ESCAPE	MESSAGE ↷	GROUND DIRECTIONAL TRIPS: 0	Range: 0 to 50000
↶ ESCAPE	MESSAGE ↷	HIGH-SET PHASE O/C TRIPS: 0	Range: 0 to 50000
↶ ESCAPE	MESSAGE ↷	UNDERVOLTAGE TRIPS: 0	Range: 0 to 50000
↶ ESCAPE	MESSAGE ↷	OVERVOLTAGE TRIPS: 0	Range: 0 to 50000
↶ ESCAPE	MESSAGE ↷	VOLTS/HERTZ TRIPS: 0	Range: 0 to 50000
↶ ESCAPE	MESSAGE ↷	PHASE REVERSAL TRIPS: 0	Range: 0 to 50000
↶ ESCAPE	MESSAGE ↷	UNDERFREQUENCY TRIPS: 0	Range: 0 to 50000
↶ ESCAPE	MESSAGE ↷	OVERFREQUENCY TRIPS: 0	Range: 0 to 50000
↶ ESCAPE	MESSAGE ↷	NEUTRAL O/V (Fund) TRIPS: 0	Range: 0 to 50000
↶ ESCAPE	MESSAGE ↷	NEUTRAL U/V (3rd) TRIPS: 0	Range: 0 to 50000
↶ ESCAPE	MESSAGE ↷	LOSS OF EXCITATION 1 TRIPS: 0	Range: 0 to 50000

ESCAPE MESSAGE	LOSS OF EXCITATION 2 TRIPS: 0	Range: 0 to 50000
ESCAPE MESSAGE	DISTANCE ZONE 1 TRIPS: 0	Range: 0 to 50000
ESCAPE MESSAGE	DISTANCE ZONE 2 TRIPS: 0	Range: 0 to 50000
ESCAPE MESSAGE	REACTIVE POWER TRIPS: 0	Range: 0 to 50000
ESCAPE MESSAGE	REVERSE POWER TRIPS: 0	Range: 0 to 50000
ESCAPE MESSAGE	LOW FORWARD POWER TRIPS: 0	Range: 0 to 50000
ESCAPE MESSAGE	STATOR RTD TRIPS: 0	Range: 0 to 50000
ESCAPE MESSAGE	BEARING RTD TRIPS: 0	Range: 0 to 50000
ESCAPE MESSAGE	OTHER RTD TRIPS: 0	Range: 0 to 50000
ESCAPE MESSAGE	AMBIENT RTD TRIPS: 0	Range: 0 to 50000
ESCAPE MESSAGE	THERMAL MODEL TRIPS: 0	Range: 0 to 50000
ESCAPE MESSAGE	INADVERTENT ENERG. TRIPS: 0	Range: 0 to 50000
ESCAPE MESSAGE	ANALOG I/P 1 TRIPS: 0	Range: 0 to 50000 <i>Reflects Analog I/P Name/units as programmed</i>
ESCAPE MESSAGE	ANALOG I/P 2 TRIPS: 0	Range: 0 to 50000 <i>Reflects Analog I/P Name/units as programmed</i>
ESCAPE MESSAGE	ANALOG I/P 3 TRIPS: 0	Range: 0 to 50000 <i>Reflects Analog I/P Name/units as programmed</i>
ESCAPE MESSAGE	ANALOG I/P 4 TRIPS: 0	Range: 0 to 50000 <i>Reflects Analog I/P Name/units as programmed</i>
ESCAPE MESSAGE	COUNTERS CLEARED: Jan 1, 1995	

The number of trips by type is displayed here. When the total reaches 50000, all counters reset. This information can be cleared with the **S1 489 SETUP / CLEAR DATA / CLEAR TRIP COUNTERS** setpoint. Trip counters will not update if a digital input programmed as Test Input is shorted. In the event of multiple trips, the only the first trip will increment the trip counters.

5.5.2 GENERAL COUNTERS

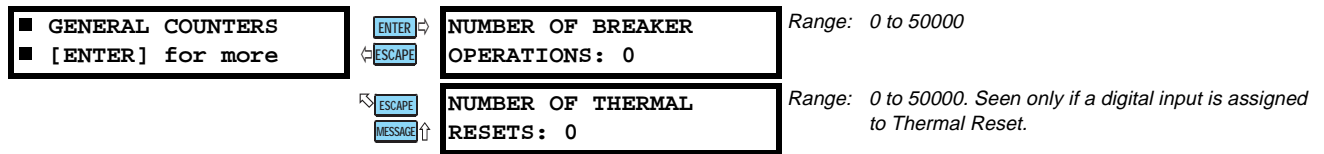

One of the 489 general counters will count the number of breaker operations over time. This may be useful information for breaker maintenance. The number of breaker operations is incremented whenever the breaker status changes from closed to open and all phase currents are zero. Another counter counts the number of thermal resets if one of the assignable digital inputs is assigned to thermal reset. This may be useful information when troubleshooting. When either of these counters reaches 50000, that counter will reset to 0. Each counter can also be cleared using the **S1 489 SETUP \ CLEAR DATA \ CLEAR BREAKER INFORMATION** setpoint. The number of breaker operations will not update if a digital input programmed as Test Input is shorted.

5.5.3 TIMERS

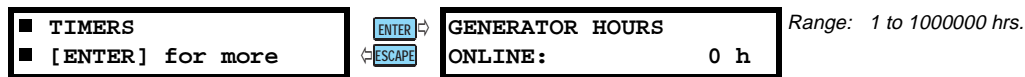

The 489 accumulates the total online time for the generator. This may be useful for scheduling routine maintenance. When this timer reaches 1000000, it resets to 0. This timer can be cleared using the **S1 489 SETUP \ CLEAR DATA \ CLEAR GENERATOR INFORMATION** setpoint. The generator hours online will not update if a digital input programmed as Test Input is shorted.

5.6.1 EVENT RECORDER

■ [ENTER] for E65535
No Event

[ENTER]	TIME OF E65535: 00:00:00.0	Range: hour:minutes:seconds Seen only if there has been an event.
[ESCAPE]	DATE OF E65535: Jan. 01, 1992	Range: month day, year Seen only if there has been an event.
[ESCAPE]	ACTIVE SETPOINT GROUP E65535: 1	Range: 1, 2
[ESCAPE]	TACHOMETER E65535: 3600 RPM	Range: 0 to 3600 RPM. Seen only if a Digital Input is programmed as Tachometer
[ESCAPE]	A: 0 B: 0 C: 0 A E65535	Range: 0 to 999999 A. Represents current measured from the output CTs. Seen only if there has been an event.
[ESCAPE]	a: 0 b: 0 c: 0 A E6	Range: 0 to 999999 A. Represents differential current. Seen only if the differential element is enabled.
[ESCAPE]	NEG. SEQ. CURRENT E65535: 0% FLA	Range: 0 to 2000% FLA Seen only if there has been an event.
[ESCAPE]	GROUND CURRENT E65535: 0.00 A	Range: 0.00 to 20000.0 A. Not seen if the GROUND CT is programmed as None.
[ESCAPE]	Vab: 0 Vbc: 0 Vca: 0 V E65535	Range: 0 to 50000 V. Not seen if VT CONNECTION is programmed as None.
[ESCAPE]	FREQUENCY E65535: 0.00 Hz	Range: 0.00 to 90.00 Hz. Not seen if VT CONNECTION is programmed as None.
[ESCAPE]	NEUTRAL VOLT (FUND) E65535: 0.0 V	Range: 0.0 to 25000.0 V. Seen only if there is a neutral voltage transformer.
[ESCAPE]	NEUTRAL VOLT (3rd) E65535: 0.0 V	Range: 0.0 to 25000.0 V Seen only if there is a neutral voltage transformer.
[ESCAPE]	Vab/Iab E65535: 0.0 Ωsec. 0°	Range: 0.0 to 6553.5 Ωsec., 0 to 359°. Seen only if the Loss of Excitation element is Enabled.
[ESCAPE]	REAL POWER (MW) E65535: 0.000	Range: 0.000 to ±2000.000 MW. Not seen if VT CONNECTION is programmed as None
[ESCAPE]	REACTIVE POWER Mvar E65535: 0.000	Range: 0.000 to ±2000.000 Mvar. Not seen if VT CONNECTION is programmed as None
[ESCAPE]	APPARENT POWER MVA E65535: 0.000	Range: 0.000 to 2000.000 MVA. Not seen if VT CONNECTION is programmed as None
[ESCAPE]	HOTTEST STATOR RTD#1: 0°C E65535	Range: -50 to +250°C. Seen only if 1 or more RTDs are programmed as Stator.
[ESCAPE]	HOTTEST BEARING RTD#7: 0°C E65535	Range: -50 to +250°C. Seen only if 1 or more RTDs are programmed as Bearing.
[ESCAPE]	HOTTEST OTHER RTD#11: 0°C E65535	Range: -50 to +250°C. Seen only if 1 or more RTDs are programmed as Other.
[ESCAPE]	AMBIENT RTD#12 0°C E65535	Range: -50 to +250°C. Seen only if 1 or more RTDs are programmed as Ambient.
[ESCAPE]	ANALOG INPUT 1 E65535: 0.0 Units	Range: -50000 to 50000 Seen only if the Analog Input is in use.

ESCAPE MESSAGE	ANALOG INPUT 2 E65535: 0.0 Units	Range: -50000 to 50000 Seen only if the Analog Input is in use.
ESCAPE MESSAGE	ANALOG INPUT 3 E65535: 0.0 Units	Range: -50000 to 50000 Seen only if the Analog Input is in use.
ESCAPE MESSAGE	ANALOG INPUT 4 E65535: 0.0 Units	Range: -50000 to 50000 Seen only if the Analog Input is in use.

The 489 Event Recorder stores generator and system information each time an event occurs. The description of the event is stored and a time and date stamp is also added to the record. This allows reconstruction of the sequence of events for troubleshooting. Events include: all trips, any alarm optionally (except Service Alarm, and 489 Not Inserted Alarm, which always records as events), loss of control power, application of control power, thermal resets, simulation, serial communication starts/stops and general input control functions optionally.

The highest event number is the most recent event, and lowest event number is the oldest event. Each new event bumps the other event records down until the 40th event is reached. The 40th event record is lost when the next event occurs. This information can be cleared using **S1 489 SETUP \ CLEAR DATA \ CLEAR EVENT RECORD** setpoint. An event number of 65535 signifies that no event has occurred since the last clearing of the event record. The event record will not update if a digital input programmed as Test Input is shorted.

Table 5–1: CAUSE OF EVENT TABLE

TRIPS	ALARMS (OPTIONAL EVENTS)	OTHER
*Input A Trip	*Input A Alarm	Service Alarm
*Input B Trip	*Input B Alarm	Control Power Lost
*Input C Trip	*Input C Alarm	Control Power Applied
*Input D Trip	*Input D Alarm	Thermal Reset Close
*Input E Trip	*Input E Alarm	Thermal Reset Open
*Input F Trip	*Input F Alarm	Serial Comm. Start
*Input G Trip	*Input G Alarm	Serial Comm. Stop
Sequential Trip	Tachometer Alarm	489 Not Inserted
Fld-Bkr Discr. Trip	Overcurrent Alarm	Simulation Started
Tachometer Trip	NegSeq Current Alarm	Simulation Stopped
Offline O/C Trip	Ground O/C Alarm	*Input A Control
Phase O/C Trip	Undervoltage Alarm	*Input B Control
Neg. Seq. O/C Trip	Overvoltage Alarm	*Input C Control
Ground O/C Trip	Volts/Hertz Alarm	*Input D Control
Differential Trip	Underfrequency Alarm	*Input E Control
Undervoltage Trip	Overfrequency Alarm	*Input F Control
Overvoltage Trip	Neutral O/V Alarm	*Input G Control
Phase Reversal Trip	Neut. U/V 3rd Alarm	Setpoint 1 Active
Volts/Hertz Trip	Reactive Power Alarm	Setpoint 2 Active
Underfrequency Trip	Reverse Power Alarm	Dig I/P Waveform Trig
Overfrequency Trip	Low Fwd Power Alarm	Serial Waveform Trig
Neutral O/V Trip	*Stator RTD 1 Alarm	IRIG-B Failure
Neut. U/V (3rd) Trip	*Stator RTD 2 Alarm	
Reactive Factor Trip	*Stator RTD 3 Alarm	
Reverse Power Trip	*Stator RTD 4 Alarm	
Low Fwd Power Trip	*Stator RTD 5 Alarm	
*Stator RTD 1 Trip	*Stator RTD 6 Alarm	
*Stator RTD 2 Trip	*Bearing RTD 7 Alarm	
*Stator RTD 3 Trip	*Bearing RTD 8 Alarm	
*Stator RTD 4 Trip	*Bearing RTD 9 Alarm	
*Stator RTD 5 Trip	*Bearing RTD10 Alarm	
*Stator RTD 6 Trip	*RTD11 Alarm	
*Bearing RTD 7 Trip	*Ambient RTD12 Alarm	
*Bearing RTD 8 Trip	Open RTD Alarm	
*Bearing RTD 9 Trip	Short/Low RTD Alarm	
*Bearing RTD10 Trip	Trip Counter Alarm	
*RTD11 Trip	Breaker Failure	
*Ambient RTD12 Trip	Trip Coil Monitor	
Thermal Model Trip	VT Fuse Fail Alarm	
*Analog I/P 1 Trip	Current Demand Alarm	
*Analog I/P 2 Trip	MW Demand Alarm	
*Analog I/P 3 Trip	Mvar Demand Alarm	
*Analog I/P 4 Trip	MVA Demand Alarm	
Loss of Excitation 1	Thermal Model Alarm	
Loss of Excitation 2	*Analog I/P 1 Alarm	
Gnd. Directional Trip	*Analog I/P 2 Alarm	
Hiset Phase O/C Trip	*Analog I/P 3 Alarm	
Distance Zone 1 Trip	*Analog I/P 4 Alarm	
Distance Zone 2 Trip	Gnd. Directional Alarm	

* reflects the name that is programmed

5.7.1 489 MODEL INFO

<ul style="list-style-type: none"> ■ 489 MODEL INFO ■ [ENTER] for more 	ENTER →	ORDER CODE:	Range: N/A
	← ESCAPE	489-P5-HI-A20	
	↩ ESCAPE	489 SERIAL NO:	Range: N/A
	MESSAGE ↕	A3260001	
	↩ ESCAPE	489 REVISION:	Range: N/A
	MESSAGE ↕	32E100A4.000	
	↩ ESCAPE	489 BOOT REVISION:	Range: N/A
	MESSAGE ↕	32E100A0.000	

All of the 489 model information may be viewed here when the unit is powered up. In the event of a product software upgrade or service question, the information shown here should be jotted down prior to any inquiry.

5.7.2 CALIBRATION INFO

<ul style="list-style-type: none"> ■ CALIBRATION INFO ■ [ENTER] for more 	ENTER →	ORIGINAL CALIBRATION	Range: month day year
	← ESCAPE	DATE: Jan 01 1996	
	↩ ESCAPE	LAST CALIBRATION	Range: month day year
	MESSAGE ↕	DATE: Jan 01 1996	

The date of the original calibration and last calibration may be viewed here.

5.8.1 DIAGNOSTIC MESSAGES FOR OPERATORS

In the event of a trip or alarm, some of the actual value messages are very helpful in diagnosing the cause of the condition. The 489 will automatically default to the most important message. The hierarchy is trip and pretrip messages, then alarm messages. In order to simplify things for the operator, the Message LED (indicator) will flash prompting the operator to press the **NEXT** key. When the **NEXT** key is pressed, the 489 will automatically display the next relevant message and continue to cycle through the messages with each keypress. When all of these conditions have cleared, the 489 will revert back to the normal default messages.

Any time the 489 is not displaying the default messages because other actual value or setpoint messages are being viewed and there are no trips or alarms, the Message LED (indicator) will be on solid. From any point in the message structure, pressing the **NEXT** key will cause the 489 to revert back to the normal default messages. When normal default messages are being displayed, pressing the **NEXT** key will cause the 489 to display the next default message immediately.

EXAMPLE:

If a thermal model trip occurred, an RTD alarm may also occur as a result of the overload. The 489 would automatically default to the **CAUSE OF LAST TRIP** message at the top of the **A1 ACTUAL VALUES \ LAST TRIP DATA** queue and the Message LED would flash. Pressing the **NEXT** key cycles through the time and date stamp information as well as all of the pre-trip data. When the bottom of this queue is reached, an additional press of the **NEXT** key would normally return to the top of the queue. However, because there is an alarm active, the display will skip to the alarm message at the top of the **A1 ACTUAL VALUES \ ALARM STATUS** queue. Finally, another press of the **NEXT** key will cause the 489 to return to the original **CAUSE OF LAST TRIP** message, and the cycle could be repeated.

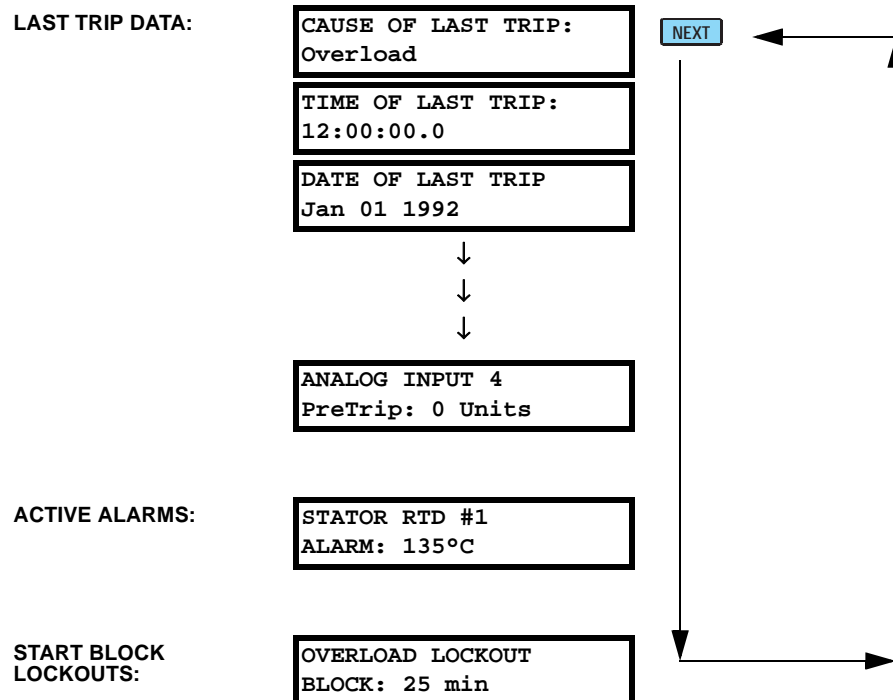

When the **RESET** has been pressed and the hot RTD condition is no longer present, the display will revert back to the normal default messages.

5.8.2 FLASH MESSAGES

Flash messages are warning, error, or general information messages that are temporarily displayed in response to certain key presses. These messages are intended to assist with navigation of the 489 messages by explaining what has happened or by prompting the user to perform certain actions.

Table 5–2: FLASH MESSAGES

NEW SETPOINT HAS BEEN STORED	ROUNDED SETPOINT HAS BEEN STORED	OUT OF RANGE. ! ENTER: ####-#### by #	ACCESS DENIED, SHORT ACCESS SWITCH	ACCESS DENIED, ENTER PASSCODE
INVALID PASSCODE ENTERED!	NEW PASSCODE HAS BEEN ACCEPTED	PASSCODE SECURITY NOT ENABLED, ENTER 0	PLEASE ENTER A NON-ZERO PASSCODE	SETPOINT ACCESS IS NOW PERMITTED
SETPOINT ACCESS IS NOW RESTRICTED	DATE ENTRY WAS NOT COMPLETE	DATE ENTRY OUT OF RANGE	TIME ENTRY WAS NOT COMPLETE	TIME ENTRY OUT OF RANGE
NO TRIPS OR ALARMS TO RESET	RESET PERFORMED SUCCESSFULLY	ALL POSSIBLE RESETS HAVE BEEN PERFORMED	CONDITION IS PRESENT RESET NOT POSSIBLE	ARE YOU SURE? PRESS [ENTER] TO VERIFY
PRESS [ENTER] TO ADD DEFAULT MESSAGE	DEFAULT MESSAGE HAS BEEN ADDED	DEFAULT MESSAGE LIST IS FULL	PRESS [ENTER] TO REMOVE MESSAGE	DEFAULT MESSAGE HAS BEEN REMOVED
DEFAULT MESSAGES 6 TO 20 ARE ASSIGNED	INVALID SERVICE CODE ENTERED	KEY PRESSED IS INVALID HERE	DATA CLEARED SUCCESSFULLY	[.] KEY IS USED TO ADVANCE THE CURSOR
TOP OF PAGE	END OF PAGE	TOP OF LIST	END OF LIST	NO ALARMS ACTIVE
THIS FEATURE NOT PROGRAMMED	THIS PARAMETER IS ALREADY ASSIGNED	THAT INPUT ALREADY USED FOR TACHOMETER	TACHOMETER MUST USE INPUT 4, 5, 6, OR 7	THAT DIGITAL INPUT IS ALREADY IN USE

- **NEW SETPOINT HAS BEEN STORED:** This message appear each time a setpoint has been altered and stored as shown on the display.
- **ROUNDED SETPOINT HAS BEEN STORED:** Since the 489 has a numeric keypad, an entered setpoint value may fall between valid setpoint values. The 489 detects this condition and store a value rounded to the nearest valid setpoint value. To find the valid range and step for a given setpoint, press the **HELP** key while the setpoint is being displayed.
- **OUT OF RANGE! ENTER: #### - #### by #:** If a setpoint value outside the acceptable range of values is entered, the 489 displays this message and substitutes proper values for that setpoint. An appropriate value may then be entered.
- **ACCESS DENIED, SHORT ACCESS SWITCH:** The Access Switch must be shorted to store any setpoint values. If this message appears and it is necessary to change a setpoint, short the Access terminals C1 and C2.
- **ACCESS DENIED, ENTER PASSCODE:** The 489 has a passcode security feature. If this feature is enabled, not only must the Access Switch terminals be shorted, but a valid passcode must also be entered. If the correct passcode has been lost or forgotten, contact the factory with the encrypted access code. All passcode features may be found in the **S1 489 SETUP \ PASSCODE** setpoints menu.
- **INVALID PASSCODE ENTERED:** This flash message appears if an invalid passcode is entered for the passcode security feature.
- **NEW PASSCODE HAS BEEN ACCEPTED:** This message will appear as an acknowledge that the new passcode has been accepted when changing the passcode for the passcode security feature.
- **PASSCODE SECURITY NOT ENABLED, ENTER 0:** The passcode security feature is disabled whenever the passcode is zero (factory default). Any attempts to enter a passcode when the feature is disabled results in this flash message, prompting the user to enter "0" as the passcode. When this has been done, the feature may be enabled by entering a non-zero passcode.
- **PLEASE ENTER A NON-ZERO PASSCODE:** The passcode security feature is disabled if the passcode is zero. If the **CHANGE PASSCODE SETPOINT** is entered as yes, this flash message appears prompting the user to enter a non-zero passcode and enable the passcode security feature.
- **SETPOINT ACCESS IS NOW PERMITTED:** Any time the passcode security feature is enabled and a valid passcode is entered, this flash message appears to notify that setpoints may now be altered and stored.
- **SETPOINT ACCESS IS NOW RESTRICTED:** If the passcode security feature is enabled and a valid passcode entered, this message appears when the **S1 489 SETUP \ PASSCODE \ SETPOINT ACCESS** setpoint is altered to "Restricted". This message also appears any time that setpoint access is permitted and the access jumper is removed.

- **DATE ENTRY WAS NOT COMPLETE:** Since the **DATE** setpoint has a special format (entered as MM/DD/YYYY), this message appears and the new value will not be stored if the **ENTER** key is pressed before *all* of the information has been entered. Another attempt will have to be made with the complete information.
- **DATE ENTRY WAS OUT OF RANGE:** Appears if an invalid entry is made for the **DATE** (for example, 15 entered for the month).
- **TIME ENTRY WAS NOT COMPLETE:** Since the **TIME** setpoint has a special format (entered as HH/MM/SS.s), this message appears and the new value will not be stored if the **ENTER** key is pressed before *all* of the information has been entered. Another attempt will have to be made with the complete information.
- **TIME ENTRY WAS OUT OF RANGE:** Appears if an invalid entry is made for the **TIME** (for example, 35 entered for the hour).
- **NO TRIPS OR ALARMS TO RESET:** Appears if the **RESET** key is pressed when there are no trips or alarms present.
- **RESET PERFORMED SUCCESSFULLY:** If all trip and alarm features that are active can be cleared (that is, the conditions that caused these trips and/or alarms are no longer present), then this message appears when a **RESET** is performed, indicating that all trips and alarms have been cleared.
- **ALL POSSIBLE RESETS HAVE BEEN PERFORMED:** If only some of the trip and alarm features that are active can be cleared (that is, the conditions that caused some of these trips and/or alarms are still present), then this message appears when a **RESET** is performed, indicating that only trips and alarms that could be reset have been reset.
- **CONDITION IS PRESENT RESET NOT POSSIBLE:** If no trip and alarm features that are active can be cleared (that is, the condition that caused these trips and/or alarms is still present), then this message appears when the **RESET** key is pressed.
- **ARE YOU SURE? PRESS [ENTER] TO VERIFY:** If the **RESET** key is pressed and resetting of any trip or alarm feature is possible, this message appears to verify the operation. If **RESET** is pressed again while this message is displayed, the reset will be performed.
- **PRESS [ENTER] TO ADD DEFAULT MESSAGE:** Appears if the decimal [.] key, immediately followed by the **ENTER** key, is entered anywhere in the actual value message structure. This message prompts the user to press **ENTER** to add a new default message. To add a new default message, **ENTER** must be pressed while this message is being displayed.
- **DEFAULT MESSAGE HAS BEEN ADDED:** Appears anytime a new default message is added to the default message list.
- **DEFAULT MESSAGE LIST IS FULL:** Appears if an attempt is made to add a new default message to the default message list when 20 messages are already assigned. To add a new message, one of the existing messages must be removed.
- **PRESS [ENTER] TO REMOVE MESSAGE:** Appears if the decimal [.] key, immediately followed by the **ENTER** key, is entered in the **S1 489 SETUP \ DEFAULT MESSAGES** setpoint page. This message prompts the user to press **ENTER** to remove a default message. To remove the default message, **ENTER** must be pressed while this message is being displayed.
- **DEFAULT MESSAGE HAS BEEN REMOVED:** Appears anytime a default message is removed from the default message list.
- **DEFAULT MESSAGES 6 of 20 ARE ASSIGNED:** Appears anytime the **S1 489 SETUP \ DEFAULT MESSAGES** setpoint page is entered, notifying the user of the number of default messages assigned.
- **INVALID SERVICE CODE ENTERED:** Appears if an invalid code is entered in the **S12 489 TESTING \ FACTORY SERVICE** setpoints page.
- **KEY PRESSED HERE IS INVALID:** Under certain situations, certain keys have no function (for example, any number key while viewing actual values). This message appears if a keypress has no current function.
- **DATA CLEARED SUCCESSFULLY:** Confirms that data is reset in the **S1 489 SETUP \ CLEAR DATA** setpoints page.
- **[.] KEY IS USED TO ADVANCE THE CURSOR:** Appears immediately to prompt the use of the [.] key for cursor control anytime a setpoint requiring text editing is viewed. If the setpoint is not altered for 1 minute, this message flashes again.
- **TOP OF PAGE:** This message will indicate when the top of a page has been reached.
- **BOTTOM OF PAGE:** This message will indicate when the bottom of a page has been reached.
- **TOP OF LIST:** This message will indicate when the top of subgroup has been reached.
- **BOTTOM OF LIST:** This message will indicate when the bottom of a subgroup has been reached.
- **NO ALARMS ACTIVE:** If an attempt is made to enter the Alarm Status message subgroup, but there are no active alarms, this message will appear.

- **THIS FEATURE NOT PROGRAMMED:** If an attempt is made to enter an actual value message subgroup, when the setpoints are not configured for that feature, this message will appear.
- **THIS PARAMETER IS ALREADY ASSIGNED:** A given analog output parameters can only be assigned to one output. If an attempt is made to assign a parameter to a second output, this message will appear.
- **THAT INPUT ALREADY USED FOR TACHOMETER:** If a digital input is assigned to the tachometer function, it cannot be used for any other digital input function. If an attempt is made to assign a digital input to a function when it is already assigned to tachometer, this message will appear.
- **TACHOMETER MUST USE INPUT 4, 5, 6, or 7:** Only digital inputs 4, 5, 6, or 7 may be used for the tachometer function. If an attempt is made to assign inputs 1,2,3, or 4 to the tachometer function, this message will appear.
- **THAT DIGITAL INPUT IS ALREADY IN USE:** If an attempt is made to assign a digital input to tachometer when it is already assigned to another function, this message will appear.
- **To edit use VALUE UP or VALUE DOWN key:** If a numeric key is pressed on a setpoint parameter that is not numeric, this message will prompt the user to use the value keys.
- **GROUP 1 SETPOINT HAS BEEN STORED:** This message appear each time a setpoint has been altered and stored to setpoint Group 1 as shown on the display.
- **GROUP 2 SETPOINT HAS BEEN STORED:** This message appear each time a setpoint has been altered and stored to setpoint Group 2 as shown on the display.

5

6.1.1 ELECTRICAL INTERFACE

The hardware or electrical interface is one of the following: one of two 2-wire RS485 ports from the rear terminal connector or the RS232 from the front panel connector. In a 2-wire RS485 link, data flow is bidirectional. Data flow is half-duplex for both the RS485 and the RS232 ports. That is, data is never transmitted and received at the same time. RS485 lines should be connected in a daisy chain configuration (avoid star connections) with a terminating network installed at each end of the link, i.e. at the master end and at the slave farthest from the master. The terminating network should consist of a 120 Ω resistor in series with a 1 nF ceramic capacitor when used with Belden 9841 RS485 wire. The value of the terminating resistors should be equal to the characteristic impedance of the line. This is approximately 120 Ω for standard #22 AWG twisted pair wire. Shielded wire should always be used to minimize noise. Polarity is important in RS485 communications. Each '+' terminal of every 489 must be connected together for the system to operate. See Section 2.2.13: RS485 COMMUNICATIONS PORTS on page 2–14 for details on correct serial port wiring.

6.1.2 MODBUS RTU PROTOCOL

The 489 implements a subset of the AEG Modicon Modbus RTU serial communication standard. Many popular programmable controllers support this protocol directly with a suitable interface card allowing direct connection of relays. Although the Modbus protocol is hardware independent, the 489 interfaces include two 2-wire RS485 ports and one RS232 port. Modbus is a single master, multiple slave protocol suitable for a multi-drop configuration as provided by RS485 hardware. In this configuration up to 32 slaves can be daisy-chained together on a single communication channel.

The 489 is always a slave. It cannot be programmed as a master. Computers or PLCs are commonly programmed as masters. The Modbus protocol exists in two versions: Remote Terminal Unit (RTU, binary) and ASCII. Only the RTU version is supported by the 489. Monitoring, programming and control functions are possible using read and write register commands.

6.1.3 DATA FRAME FORMAT AND DATA RATE

One data frame of an asynchronous transmission to or from a 489 is default to 1 start bit, 8 data bits, and 1 stop bit. This produces a 10-bit data frame. This is important for transmission through modems at high bit rates (11 bit data frames are not supported by Hayes modems at bit rates of greater than 300 bps). The parity bit is optional as odd or even. If it is programmed as odd or even, the data frame consists of 1 start bit, 8 data bits, 1 parity bit, and 1 stop bit.

Modbus protocol can be implemented at any standard communication speed. The 489 RS485 ports support operation at 1200, 2400, 4800, 9600, and 19200 baud. The front panel RS232 baud rate is fixed at 9600 baud.

6.1.4 DATA PACKET FORMAT

A complete request/response sequence consists of the following bytes (transmitted as separate data frames):

MASTER QUERY MESSAGE:	
SLAVE ADDRESS:	(1 byte)
FUNCTION CODE:	(1 byte)
DATA:	(variable number of bytes depending on FUNCTION CODE)
CRC:	(2 bytes)
SLAVE RESPONSE MESSAGE:	
SLAVE ADDRESS:	(1 byte)
FUNCTION CODE:	(1 byte)
DATA:	(variable number of bytes depending on FUNCTION CODE)
CRC:	(2 bytes)

- SLAVE ADDRESS:** This is the first byte of every transmission. This byte represents the user-assigned address of the slave device that is to receive the message sent by the master. Each slave device must be assigned a unique address and only the addressed slave will respond to a transmission that starts with its address. In a master request transmission the SLAVE ADDRESS represents the address of the slave to which the request is being sent. In a slave response transmission the SLAVE ADDRESS represents the address of the slave that is sending the response. The RS232 port

ignores the slave address, so it will respond regardless of the value in the message. Note: A master transmission with a SLAVE ADDRESS of 0 indicates a broadcast command. Broadcast commands can be used for specific functions.

- **FUNCTION CODE:** This is the second byte of every transmission. Modbus defines function codes of 1 to 127. The 489 implements some of these functions. In a master request transmission the FUNCTION CODE tells the slave what action to perform. In a slave response transmission if the FUNCTION CODE sent from the slave is the same as the FUNCTION CODE sent from the master indicating the slave performed the function as requested. If the high order bit of the FUNCTION CODE sent from the slave is a 1 (i.e. if the FUNCTION CODE is greater than 127) then the slave did not perform the function as requested and is sending an error or exception response.
- **DATA:** This will be a variable number of bytes depending on the FUNCTION CODE. This may be Actual Values, Set-points, or addresses sent by the master to the slave or by the slave to the master. Data is sent MSByte first followed by the LSByte.
- **CRC:** This is a two byte error checking code. CRC is sent LSByte first followed by the MSByte. The RTU version of Modbus includes a two byte CRC-16 (16-bit cyclic redundancy check) with every transmission. The CRC-16 algorithm essentially treats the entire data stream (data bits only; start, stop and parity ignored) as one continuous binary number. This number is first shifted left 16 bits and then divided by a characteristic polynomial (11000000000000101B). The 16-bit remainder of the division is appended to the end of the transmission, LSByte first. The resulting message including CRC, when divided by the same polynomial at the receiver will give a zero remainder if no transmission errors have occurred.

If a 489 Modbus slave device receives a transmission in which an error is indicated by the CRC-16 calculation, the slave device will not respond to the transmission. A CRC-16 error indicates that one or more bytes of the transmission were received incorrectly and thus the entire transmission should be ignored in order to avoid the 489 performing any incorrect operation.

The CRC-16 calculation is an industry standard method used for error detection. An algorithm is included here to assist programmers in situations where no standard CRC-16 calculation routines are available.

6.1.5 CRC-16 ALGORITHM

Once the following algorithm is complete, the working register "A" will contain the CRC value to be transmitted. Note that this algorithm requires the characteristic polynomial to be reverse bit ordered. The MSbit of the characteristic polynomial is dropped since it does not affect the value of the remainder. The following symbols are used in the algorithm:

Symbols: --> data transfer

A 16 bit working register

A_{low} low order byte of A

A_{high} high order byte of A

CRC 16 bit CRC-16 result

i, j loop counters

(+) logical EXCLUSIVE-OR operator

N total number of data bytes

D_i i-th data byte (i = 0 to N-1)

G 16 bit characteristic polynomial = 1010000000000001 (binary) with MSbit dropped and bit order reversed

shr (x) right shift operator (the LSbit of x is shifted into a carry flag, a '0' is shifted into the MSbit of x, all other bits are shifted right one location)

Algorithm:

1. FFFF (hex) --> A
2. 0 --> i
3. 0 --> j
4. D_i (+) A_{low} --> A_{low}
5. j + 1 --> j
6. shr (A)
7. Is there a carry? No: go to step 8.
Yes: G (+) A --> A and continue.
8. Is j = 8? No: go to 5.
Yes: continue.
9. i + 1 --> i
10. Is i = N? No: go to 3.
Yes: continue.
11. A --> CRC

6.1.6 TIMING

Data packet synchronization is maintained by timing constraints. The receiving device must measure the time between the reception of characters. If three and one half character times elapse without a new character or completion of the packet, then the communication link must be reset (i.e. all slaves start listening for a new transmission from the master). Thus at 9600 baud a delay of greater than $3.5 \times 1 / 9600 \times 10 = 3.65$ ms will cause the communication link to be reset.

The following functions are supported by the 489:

- 03 - Read Setpoints and Actual Values
- 04 - Read Setpoints and Actual Values
- 05 - Execute Operation
- 06 - Store Single Setpoint
- 07 - Read Device Status
- 08 - Loopback Test
- 16 - Store Multiple Setpoints

6.2.2 FUNCTION CODES 03/04: READ SETPOINTS/ACTUAL VALUES

Modbus implementation: Read Input and Holding Registers

489 Implementation: Read Setpoints and Actual Values

For the 489 Modbus implementation, these commands are used to read any setpoint ("holding registers") or actual value ("input registers"). Holding and input registers are 16-bit (two byte) values transmitted high order byte first. Thus all 469 setpoints and actual values are sent as two bytes. The maximum of 125 registers can be read in one transmission. Function codes 03 and 04 are configured to read setpoints or actual values interchangeably since some PLCs do not support both function codes.

The slave response to these function codes is the slave address, function code, a count of the number of data bytes to follow, the data itself and the CRC. Each data item is sent as a two byte number with the high order byte sent first. The CRC is sent as a two byte number with the low order byte sent first.

MESSAGE FORMAT AND EXAMPLE

Request slave 11 to respond with 2 registers starting at address 0235. For this example, the register data in these addresses is:

ADDRESS	DATA
0235	0064
0236	000A

MASTER TRANSMISSION:	BYTES	EXAMPLE (HEX):	
SLAVE ADDRESS	1	0B	message for slave 11
FUNCTION CODE	1	03	read registers
DATA STARTING ADDRESS	2	02 35	data starting at 0235
NUMBER OF SETPOINTS	2	00 02	2 registers (4 bytes total)
CRC	2	D5 17	CRC calculated by the master

SLAVE RESPONSE:	BYTES	EXAMPLE (HEX):	
SLAVE ADDRESS	1	0B	response message from slave 11
FUNCTION CODE	1	03	read registers
BYTE COUNT	1	04	2 registers = 4 bytes
DATA 1	2	00 64	value in address 0308
DATA 2	2	00 0A	value in address 0309
CRC	2	EB 91	CRC calculated by the slave

6.2.3 FUNCTION CODE 05: EXECUTE OPERATION

Modbus Implementation: Force Single Coil
 489 Implementation: Execute Operation

This function code allows the master to request specific 489 command operations. The command numbers listed in the Commands area of the memory map correspond to operation code for function code 05. The operation commands can also be initiated by writing to the Commands area of the memory map using function code 16. Refer to FUNCTION 16: STORE MULTIPLE SETPOINTS for complete details.

Supported Operations: Reset 489 (operation code 1); Generator Start (operation code 2);
 Generator Stop (operation code 3); Waveform Trigger (operation code 4)

MESSAGE FORMAT AND EXAMPLE

Reset 489 (operation code 1).

MASTER TRANSMISSION:	BYTES	EXAMPLE (HEX):	
SLAVE ADDRESS	1	0B	message for slave 11
FUNCTION CODE	1	05	execute operation
OPERATION CODE	2	00 01	reset command (operation code 1)
CODE VALUE	2	FF 00	perform function
CRC	2	DD 50	CRC calculated by the master

SLAVE RESPONSE:	BYTES	EXAMPLE (HEX):	
SLAVE ADDRESS	1	0B	response message from slave 11
FUNCTION CODE	1	05	execute operation
OPERATION CODE	2	00 01	reset command (operation code 1)
CODE VALUE	2	FF 00	perform function
CRC	2	DD 50	CRC calculated by the slave

6.2.4 FUNCTION CODE 06: STORE SINGLE SETPOINT

Modbus Implementation: Preset Single Register
 489 Implementation: Store Single Setpoint

This command allows the master to store a single setpoint into the 489 memory. The slave response to this function code is to echo the entire master transmission.

MESSAGE FORMAT AND EXAMPLE

Request slave 11 to store the value 01F4 in Setpoint address 1180. After the transmission in this example is complete, Setpoints address 1180 will contain the value 01F4.

MASTER TRANSMISSION:	BYTES	EXAMPLE (HEX):	
SLAVE ADDRESS	1	0B	message for slave 11
FUNCTION CODE	1	06	store single setpoint
DATA STARTING ADDRESS	2	11 80	setpoint address 1180
DATA	2	01 F4	data for address 1180
CRC	2	8D A3	CRC calculated by the master

SLAVE RESPONSE:	BYTES	EXAMPLE (HEX):	
SLAVE ADDRESS	1	0B	message for slave 11
FUNCTION CODE	1	06	store single setpoint
DATA STARTING ADDRESS	2	11 80	setpoint address 1180
DATA	2	01 F4	data for address 1180
CRC	2	8D A3	CRC calculated by the slave

6.2.5 FUNCTION CODE 07: READ DEVICE STATUS

Modbus Implementation: Read Exception Status

489 Implementation: Read Device Status

This function reads the selected device status. A short message length allows for rapid reading of status. The returned status byte has individual bits set to 1 or 0 depending on the slave device status. The 489 general status byte is shown below:

BIT NO.	DESCRIPTION
B0	R1 Trip relay operated = 1
B1	R2 Auxiliary relay operated = 1
B2	R3 Auxiliary relay operated = 1
B3	R4 Auxiliary relay operated = 1
B4	R5 Alarm start relay operated = 1
B5	R6 Service relay operated = 1
B6	Stopped = 1
B7	Running = 1

Note that if status is neither stopped or running, the generator is starting.

MESSAGE FORMAT AND EXAMPLE

Request status from slave 11.

MASTER TRANSMISSION:	BYTES	EXAMPLE (HEX):
SLAVE ADDRESS	1	0B message for slave 11
FUNCTION CODE	1	07 read device status
CRC	2	47 42 CRC calculated by the master

SLAVE RESPONSE:	BYTES	EXAMPLE (HEX):
SLAVE ADDRESS	1	0B message for slave 11
FUNCTION CODE	1	07 read device status
DEVICE STATUS	1	59 status = 01011001 in binary
CRC	2	C2 08 CRC calculated by the slave

6.2.6 FUNCTION CODE 08: LOOPBACK TEST

Modbus Implementation: Loopback Test

489 Implementation: Loopback Test

This function is used to test the integrity of the communication link. The 489 will echo the request.

MESSAGE FORMAT AND EXAMPLE

Loopback test from slave 11.

MASTER TRANSMISSION:	BYTES	EXAMPLE (HEX):
SLAVE ADDRESS	1	0B message for slave 11
FUNCTION CODE	1	08 loopback test
DIAG CODE	2	00 00 must be 00 00
DATA	2	00 00 must be 00 00
CRC	2	E0 A1 CRC calculated by the master

SLAVE RESPONSE:	BYTES	EXAMPLE (HEX):
SLAVE ADDRESS	1	0B message for slave 11
FUNCTION CODE	1	08 loopback test
DIAG CODE	2	00 00 must be 00 00
DATA	2	00 00 must be 00 00
CRC	2	E0 A1 CRC calculated by the slave

6.2.7 FUNCTION CODE 16: STORE MULTIPLE SETPOINTS

Modbus Implementation: Preset Multiple Registers

489 Implementation: Store Multiple Setpoints

This function code allows multiple Setpoints to be stored into the 489 memory. Modbus "registers" are 16-bit (two byte) values transmitted high order byte first. Thus all 489 setpoints are sent as two bytes. The maximum number of Setpoints that can be stored in one transmission is dependent on the slave device. Modbus allows up to a maximum of 60 holding registers to be stored. The 489 response to this function code is to echo the slave address, function code, starting address, the number of Setpoints stored, and the CRC.

MESSAGE FORMAT AND EXAMPLE

Request slave 11 to store the value 01F4 to Setpoint address 1180 and the value 0001 to setpoint address 1181. After the transmission in this example is complete, 489 slave 11 will have the following Setpoints information stored:

ADDRESS	DATA
1180	01F4
1181	0001

MASTER TRANSMISSION:	BYTES	EXAMPLE (hex):	
SLAVE ADDRESS	1	0B	message for slave 11
FUNCTION CODE	1	10	store setpoints
DATA STARTING ADDRESS	2	11 80	data starting at 1180
NUMBER OF SETPOINTS	2	00 02	2 setpoints (4 bytes total)
BYTE COUNT	1	04	2 registers = 4 bytes
DATA 1	2	01 F4	data for address 1180
DATA 2	2	00 01	data for address 1181
CRC	2	9B 89	CRC calculated by the master

SLAVE RESPONSE:	BYTES	EXAMPLE (hex):	
SLAVE ADDRESS	1	0B	response message from slave 11
FUNCTION CODE	1	10	store setpoints
DATA STARTING ADDRESS	2	11 80	data starting at 1180
NUMBER OF SETPOINTS	2	00 02	2 setpoints (4 bytes total)
CRC	2	45 B6	CRC calculated by the slave

6.2.8 FUNCTION CODE 16: PERFORMING COMMANDS

Some PLCs may not support execution of commands using function code 5 but do support storing multiple setpoints using function code 16. To perform this operation using function code 16 (10H), a certain sequence of commands must be written at the same time to the 489. The sequence consists of: Command Function register, Command operation register and Command Data (if required). The Command Function register must be written with the value of 5 indicating an execute operation is requested. The Command Operation register must then be written with a valid command operation number from the list of commands shown in the memory map. The Command Data registers must be written with valid data if the command operation requires data. The selected command will execute immediately upon receipt of a valid transmission.

MESSAGE FORMAT AND EXAMPLE

Perform a 489 RESET (operation code 1).

MASTER TRANSMISSION:	BYTES	EXAMPLE (HEX):	
SLAVE ADDRESS	1	0B	message for slave 11
FUNCTION CODE	1	10	store setpoints
DATA STARTING ADDRESS	2	00 80	setpoint address 0080
NUMBER OF SETPOINTS	2	00 02	2 setpoints (4 bytes total)
BYTE COUNT	1	04	2 registers = 4 bytes
COMMAND FUNCTION	2	00 05	data for address 0080
COMMAND FUNCTION	2	00 01	data for address 0081
CRC	2	0B D6	CRC calculated by the master

SLAVE RESPONSE:	BYTES	EXAMPLE (HEX):	
SLAVE ADDRESS	1	0B	response message from slave 11
FUNCTION CODE	1	10	store setpoints
DATA STARTING ADDRESS	2	00 80	setpoint address 0080
NUMBER OF SETPOINTS	2	00 02	2 setpoints (4 bytes total)
CRC	2	40 8A	CRC calculated by the slave

6.2.9 ERROR RESPONSES

When a 489 detects an error other than a CRC error, a response will be sent to the master. The MSbit of the FUNCTION CODE byte will be set to 1 (i.e. the function code sent from the slave will be equal to the function code sent from the master plus 128). The following byte will be an exception code indicating the type of error that occurred.

Transmissions received from the master with CRC errors will be ignored by the 489.

The slave response to an error (other than CRC error) will be:

- SLAVE ADDRESS: 1 byte
- FUNCTION CODE: 1 byte (with MSbit set to 1)
- EXCEPTION CODE: 1 byte
- CRC: 2 bytes

The 489 implements the following exception response codes.

01: ILLEGAL FUNCTION

The function code transmitted is not one of the functions supported by the 489.

02: ILLEGAL DATA ADDRESS

The address referenced in the data field transmitted by the master is not an allowable address for the 489.

03: ILLEGAL DATA VALUE

The value referenced in the data field transmitted by the master is not within range for the selected data address.

6.3.1 MEMORY MAP INFORMATION

The data stored in the 489 is grouped as Setpoints and Actual Values. Setpoints can be read and written by a master computer. Actual Values are read only. All Setpoints and Actual Values are stored as two byte values. That is, each register address is the address of a two-byte value. Addresses are listed in hexadecimal. Data values (Setpoint ranges, increments, and factory values) are in decimal.



Many Modbus communications drivers add 40001d to the actual address of the register addresses. For example: if address 0h was to be read, 40001d would be the address required by the Modbus communications driver; if address 320h (800d) was to be read, 40801d would be the address required by the Modbus communications driver.

6.3.2 USER DEFINABLE MEMORY MAP AREA

The 489 contains a User Definable area in the memory map. This area allows remapping of the addresses of all Actual Values and Setpoints registers. The User Definable area has two sections:

1. A Register Index area (memory map addresses 0180h to 01FCh) that contains 125 Actual Values or Setpoints register addresses.
2. A Register area (memory map addresses 0100h to 017Ch) that contains the data at the addresses in the Register Index.

Register data that is separated in the rest of the memory map may be remapped to adjacent register addresses in the User Definable Registers area. This is accomplished by writing to register addresses in the User Definable Register Index area. This allows for improved throughput of data and can eliminate the need for multiple read command sequences.

For example, if the values of Average Phase Current (register addresses 0412h and 0413h) and Hottest Stator RTD Temperature (register address 04A0h) are required to be read from an 489, their addresses may be remapped as follows:

1. Write 0412h to address 0180h (User Definable Register Index 0000) using function code 06 or 16.
2. Write 0413h to address 0181h (User Definable Register Index 0001) using function code 06 or 16. (Average Phase Current is a double register number)
3. Write 04A0h to address 0182h (User Definable Register Index 0001) using function code 06 or 16.

A read (function code 03 or 04) of registers 0100h (User Definable Register 0000) and 0101h (User Definable Register 0001) will return the Average Phase Current and register 0102h (User Definable Register 0002) will return the Hottest Stator RTD Temperature.

6.3.3 EVENT RECORDER

The 489 event recorder data starts at address 3000h. Address 3003h is the ID number of the event of interest (a high number representing the latest event and a low number representing the oldest event). Event numbers start at zero each time the event record is cleared, and count upwards. To retrieve event 1, write '1' to the Event Record Selector (3003h) and read the data from 3004h to 30E7h. To retrieve event 2, write '2' to the Event Record Selector (3003h) and read the data from 3004h to 30E7h. All 40 events may be retrieved in this manner. The time and date stamp of each event may be used to ensure that all events have been retrieved in order without new events corrupting the sequence of events (event 0 should be less recent than event 1, event 1 should be less recent than event 2, etc.).

If more than 40 events have been recorded since the last time the event record was cleared, the earliest events will not be accessible. For example, if 100 events have been recorded (i.e., the total events since last clear in register 3002h is 100), events 60 through 99 may be retrieved. Writing any other value to the event record selector (register 3003h) will result in an "invalid data value" error.

Each communications port can individually select the ID number of the event of interest by writing address 3003h. This way the front port, rear port and auxiliary port can read different events from the event recorder simultaneously.

6.3.4 WAVEFORM CAPTURE

The 489 stores up to 64 cycles of A/D samples in a waveform capture buffer each time a trip occurs. The waveform capture buffer is time and date stamped and may therefore be correlated to a trip in the event record. To access the waveform capture memory, select the channel of interest by writing the number to the Waveform Capture Channel Selector (30F5h). Then read the waveform capture data from address 3100h-31BFh, and read the date, time and line frequency from addresses 30F0h-30F4h.

Each communications port can individually select a Waveform Channel Selector of interest by writing address 30F5h. This way the front port, rear port and auxiliary port can read different Waveform Channels simultaneously.

The channel selector must be one of the following values:

VALUE	SELECTED A/D SAMPLES	SCALE FACTOR
0	Phase A line current	500 counts equals 1 × CT primary
1	Phase B line current	500 counts equals 1 × CT primary
2	Phase C line current	500 counts equals 1 × CT primary
3	Neutral-end phase A current	500 counts equals 1 × CT primary
4	Neutral-end phase B current	500 counts equals 1 × CT primary
5	Neutral-end phase C current	500 counts equals 1 × CT primary
6	Ground current	500 counts equals 1 × CT primary or 1A for 50:0.025
7	Phase A to neutral voltage	2500 counts equals 120 secondary volts
8	Phase B to neutral voltage	2500 counts equals 120 secondary volts
9	Phase C to neutral voltage	2500 counts equals 120 secondary volts

6.3.5 DUAL SETPOINTS

Each communications port can individually select an Edit Setpoint Group of interest by writing address 1342h. This way the front port, rear port and auxiliary port can read and alter different setpoints simultaneously.

6.3.6 PASSCODE OPERATION

Each communications port can individually set the Passcode Access by writing address 88h with the correct Passcode. This way the front port, rear port and auxiliary port have individual access to the setpoints. Reading address 203h, COMMUNICATIONS SETPOINT ACCESS register, will provide the user with the current state of access for the given port. A value of 1 read from this register indicates that the user has full access rights to changing setpoints from the given port.

6.3.7 489 MEMORY MAP

Table 6–1: 489 MEMORY MAP (Sheet 1 of 29)

ADDR	NAME	RANGE	STEP	UNITS	FORMAT	DEFAULT
PRODUCT ID						
0000	GE POWER MANAGEMENT PRODUCT DEVICE CODE	N/A	N/A	N/A	F1	32
0001	PRODUCT HARDWARE REVISION	1 to 26	1	N/A	F15	N/A
0002	PRODUCT SOFTWARE REVISION	N/A	N/A	N/A	F16	N/A
0003	PRODUCT MODIFICATION NUMBER	0 to 999	1	N/A	F1	N/A
0010	BOOT PROGRAM REVISION	N/A	N/A	N/A	F16	N/A
0011	BOOT PROGRAM MODIFICATION NUMBER	0 to 999	1	N/A	F1	N/A
MODEL ID						
0040	ORDER CODE	0 to 16	1	N/A	F22	N/A
0050	489 REVISION	12	1	N/A	F22	N/A
0060	489 BOOT REVISION	12	1	N/A	F22	N/A
COMMANDS						
0080	COMMAND FUNCTION CODE (always 5)	5	N/A	N/A	F1	N/A
0081	COMMAND OPERATION CODE	0 to 65535	1	N/A	F1	N/A
0088	COMMUNICATIONS PORT PASSCODE	0 to 99999999	1	N/A	F12	0
00F0	TIME (BROADCAST)	N/A	N/A	N/A	F24	N/A
00F2	DATE (BROADCAST)	N/A	N/A	N/A	F18	N/A
USER_MAP / USER MAP VALUES						
0100	USER MAP VALUE #1 of 125...	5	N/A	N/A	F1	N/A
017C	USER MAP VALUE #125 of 125	5	N/A	N/A	F1	N/A
USER_MAP / USER MAP ADDRESSES						
0180	USER MAP ADDRESS #1 of 125...	0 to 3FFF	1	hex	F1	0
01FC	USER MAP ADDRESS #125 of 125	0 to 3FFF	1	hex	F1	0
STATUS / GENERATOR STATUS						
0200	GENERATOR STATUS	0 to 4	1	–	F133	1
0201	GENERATOR THERMAL CAPACITY USED	0 to 100	1	%	F1	0
0202	ESTIMATED TRIP TIME ON OVERLOAD	0 to 65535 ¹	1	s	F12	–1
0203	COMMUNICATIONS SETPOINT ACCESS	0 to 1	N/A	N/A	F126	N/A
STATUS / SYSTEM STATUS						
0210	GENERAL STATUS	0 to 65535	1	N/A	F140	0
0211	OUTPUT RELAY STATUS	0 to 63	1	N/A	F141	0
0212	ACTIVE SETPOINT GROUP	0 to 1	1	N/A	F118	0
STATUS / LAST TRIP DATA						
0220	CAUSE OF LAST TRIP	0 to 139	1	–	F134	0
0221	TIME OF LAST TRIP	N/A	N/A	N/A	F19	N/A
0223	DATE OF LAST TRIP	N/A	N/A	N/A	F18	N/A
0225	TACHOMETER PreTrip	0 to 7200	1	RPM	F1	0
0226	PHASE A PRE-TRIP CURRENT	0 to 999999	1	Amps	F12	0
0228	PHASE B PRE-TRIP CURRENT	0 to 999999	1	Amps	F12	0
022A	PHASE C PRE-TRIP CURRENT	0 to 999999	1	Amps	F12	0
022C	PHASE A PRE-TRIP DIFFERENTIAL CURRENT	0 to 999999	1	Amps	F12	0
022E	PHASE B PRE-TRIP DIFFERENTIAL CURRENT	0 to 999999	1	Amps	F12	0
0230	PHASE C PRE-TRIP DIFFERENTIAL CURRENT	0 to 999999	1	Amps	F12	0
0232	NEG. SEQ. CURRENT PreTrip	0 to 2000	1	% FLA	F1	0
0233	GROUND CURRENT PreTrip	0 to 20000000	1	A	F14	0
0235	PRE-TRIP A-B VOLTAGE	0 to 50000	1	Volts	F1	0
0236	PRE-TRIP B-C VOLTAGE	0 to 50000	1	Volts	F1	0
0237	PRE-TRIP C-A VOLTAGE	0 to 50000	1	Volts	F1	0
0238	FREQUENCY Pretrip	0 to 12000	1	Hz	F3	0
023B	REAL POWER (MW) PreTrip	–2000000 to 2000000	1	MW	F13	0

1, 2, 3 See Table footnotes on page 6–39

Table 6–1: 489 MEMORY MAP (Sheet 2 of 29)

ADDR	NAME	RANGE	STEP	UNITS	FORMAT	DEFAULT
023D	REACTIVE POWER Mvar PreTrip	–2000000 to 2000000	1	Mvar	F13	0
023F	APPARENT POWER MVA PreTrip	0 to 2000000	1	MVA	F13	0
0241	LAST TRIP DATA STATOR RTD	1 to 12	1	–	F1	1
0242	HOTTEST STATOR RTD TEMPERATURE	–50 to 250	1	°C	F4	0
0243	LAST TRIP DATA BEARING RTD	1 to 12	1	–	F1	1
0244	HOTTEST BEARING RTD TEMPERATURE	–50 to 250	1	°C	F4	0
0245	LAST TRIP DATA OTHER RTD	1 to 12	1	–	F1	1
0246	HOTTEST OTHER RTD TEMPERATURE	–50 to 250	1	°C	F4	0
0247	LAST TRIP DATA AMBIENT RTD	1 to 12	1	–	F1	1
0248	HOTTEST AMBIENT RTD TEMPERATURE	–50 to 250	1	°C	F4	0
0249	ANALOG IN 1 PreTrip	–50000 to 50000	1	Units	F12	0
024B	ANALOG IN 2 PreTrip	–50000 to 50000	1	Units	F12	0
024D	ANALOG IN 3 PreTrip	–50000 to 50000	1	Units	F12	0
024F	ANALOG IN 4 PreTrip	–50000 to 50000	1	Units	F12	0
025C	HOTTEST STATOR RTD TEMPERATURE	–50 to 250	1	°F	F4	0
025D	HOTTEST BEARING RTD TEMPERATURE	–50 to 250	1	°F	F4	0
025E	HOTTEST OTHER RTD TEMPERATURE	–50 to 250	1	°F	F4	0
025F	HOTTEST AMBIENT RTD TEMPERATURE	–50 to 250	1	°F	F4	0
0260	NEUTRAL VOLT FUND PreTrip	0 to 250000	1	Volts	F10	0
0262	NEUTRAL VOLT 3rd PreTrip	0 to 250000	1	Volts	F10	0
0264	PRE-TRIP Vab/lab	0 to 65535	1	ohms s	F2	0
0265	PRE-TRIP Vab/lab ANGLE	0 to 359	1	°	F1	0
STATUS / TRIP PICKUPS						
0280	INPUT A PICKUP	0 to 4	1	–	F123	0
0281	INPUT B PICKUP	0 to 4	1	–	F123	0
0282	INPUT C PICKUP	0 to 4	1	–	F123	0
0283	INPUT D PICKUP	0 to 4	1	–	F123	0
0284	INPUT E PICKUP	0 to 4	1	–	F123	0
0285	INPUT F PICKUP	0 to 4	1	–	F123	0
0286	INPUT G PICKUP	0 to 4	1	–	F123	0
0287	SEQUENTIAL TRIP PICKUP	0 to 4	1	–	F123	0
0288	FIELD-BKR DISCREP. PICKUP	0 to 4	1	–	F123	0
0289	TACHOMETER PICKUP	0 to 4	1	–	F123	0
028A	OFFLINE OVERCURRENT PICKUP	0 to 4	1	–	F123	0
028B	INADVERTENT ENERG. PICKUP	0 to 4	1	–	F123	0
028C	PHASE OVERCURRENT PICKUP	0 to 4	1	–	F123	0
028D	NEG.SEQ. OVERCURRENT PICKUP	0 to 4	1	–	F123	0
028E	GROUND OVERCURRENT PICKUP	0 to 4	1	–	F123	0
028F	PHASE DIFFERENTIAL PICKUP	0 to 4	1	–	F123	0
0290	UNDERVOLTAGE PICKUP	0 to 4	1	–	F123	0
0291	OVERVOLTAGE PICKUP	0 to 4	1	–	F123	0
0292	VOLTS/HERTZ PICKUP	0 to 4	1	–	F123	0
0293	PHASE REVERSAL PICKUP	0 to 4	1	–	F123	0
0294	UNDERFREQUENCY PICKUP	0 to 4	1	–	F123	0
0295	OVERFREQUENCY PICKUP	0 to 4	1	–	F123	0
0296	NEUTRAL O/V (FUND) PICKUP	0 to 4	1	–	F123	0
0297	NEUTRAL U/V (3rd) PICKUP	0 to 4	1	–	F123	0
0298	REACTIVE POWER PICKUP	0 to 4	1	–	F123	0
0299	REVERSE POWER PICKUP	0 to 4	1	–	F123	0
029A	LOW FORWARD POWER PICKUP	0 to 4	1	–	F123	0
029B	THERMAL MODEL PICKUP	0 to 4	1	–	F123	0
029C	RTD #1 PICKUP	0 to 4	1	–	F123	0
029D	RTD #2 PICKUP	0 to 4	1	–	F123	0

1, 2, 3 See Table footnotes on page 6–39

Table 6–1: 489 MEMORY MAP (Sheet 3 of 29)

ADDR	NAME	RANGE	STEP	UNITS	FORMAT	DEFAULT
029E	RTD #3 PICKUP	0 to 4	1	–	F123	0
029F	RTD #4 PICKUP	0 to 4	1	–	F123	0
02A0	RTD #5 PICKUP	0 to 4	1	–	F123	0
02A1	RTD #6 PICKUP	0 to 4	1	–	F123	0
02A2	RTD #7 PICKUP	0 to 4	1	–	F123	0
02A3	RTD #8 PICKUP	0 to 4	1	–	F123	0
02A4	RTD #9 PICKUP	0 to 4	1	–	F123	0
02A5	RTD #10 PICKUP	0 to 4	1	–	F123	0
02A6	RTD #11 PICKUP	0 to 4	1	–	F123	0
02A7	RTD #12 PICKUP	0 to 4	1	–	F123	0
02A8	Analog I/P 1 PICKUP	0 to 4	1	–	F123	0
02A9	Analog I/P 2 PICKUP	0 to 4	1	–	F123	0
02AA	Analog I/P 3 PICKUP	0 to 4	1	–	F123	0
02AB	Analog I/P 4 PICKUP	0 to 4	1	–	F123	0
02AC	LOSS OF EXCITATION 1 PICKUP	0 to 4	1	–	F123	0
02AD	LOSS OF EXCITATION 2 PICKUP	0 to 4	1	–	F123	0
02AE	GROUND DIRECTIONAL PICKUP	0 to 4	1	–	F123	0
02AF	HIGH-SET PHASE O/C PICKUP	0 to 4	1	–	F123	0
02B0	DISTANCE ZONE 1 PICKUP	0 to 4	1	–	F123	0
02B1	DISTANCE ZONE 2 PICKUP	0 to 4	1	–	F123	0
STATUS / ALARM PICKUPS						
0300	INPUT A PICKUP	0 to 4	1	–	F123	0
0301	INPUT B PICKUP	0 to 4	1	–	F123	0
0302	INPUT C PICKUP	0 to 4	1	–	F123	0
0303	INPUT D PICKUP	0 to 4	1	–	F123	0
0304	INPUT E PICKUP	0 to 4	1	–	F123	0
0305	INPUT F PICKUP	0 to 4	1	–	F123	0
0306	INPUT G PICKUP	0 to 4	1	–	F123	0
0307	TACHOMETER PICKUP	0 to 4	1	–	F123	0
0308	OVERCURRENT PICKUP	0 to 4	1	–	F123	0
0309	NEG SEQ OVERCURRENT PICKUP	0 to 4	1	–	F123	0
030A	GROUND OVERCURRENT PICKUP	0 to 4	1	–	F123	0
030B	UNDERVOLTAGE PICKUP	0 to 4	1	–	F123	0
030C	OVERVOLTAGE PICKUP	0 to 4	1	–	F123	0
030D	VOLTS/HERTZ PICKUP	0 to 4	1	–	F123	0
030E	UNDERFREQUENCY PICKUP	0 to 4	1	–	F123	0
030F	OVERFREQUENCY PICKUP	0 to 4	1	–	F123	0
0310	NEUTRAL O/V (FUND) PICKUP	0 to 4	1	–	F123	0
0311	NEUTRAL U/V (3rd) PICKUP	0 to 4	1	–	F123	0
0312	REACTIVE POWER PICKUP	0 to 4	1	–	F123	0
0313	REVERSE POWER PICKUP	0 to 4	1	–	F123	0
0314	LOW FORWARD POWER PICKUP	0 to 4	1	–	F123	0
0315	RTD #1 PICKUP	0 to 4	1	–	F123	0
0316	RTD #2 PICKUP	0 to 4	1	–	F123	0
0317	RTD #3 PICKUP	0 to 4	1	–	F123	0
0318	RTD #4 PICKUP	0 to 4	1	–	F123	0
0319	RTD #5 PICKUP	0 to 4	1	–	F123	0
031A	RTD #6 PICKUP	0 to 4	1	–	F123	0
031B	RTD #7 PICKUP	0 to 4	1	–	F123	0
031C	RTD #8 PICKUP	0 to 4	1	–	F123	0
031D	RTD #9 PICKUP	0 to 4	1	–	F123	0
031E	RTD #10 PICKUP	0 to 4	1	–	F123	0
031F	RTD #11 PICKUP	0 to 4	1	–	F123	0

1, 2, 3 See Table footnotes on page 6–39

Table 6–1: 489 MEMORY MAP (Sheet 4 of 29)

ADDR	NAME	RANGE	STEP	UNITS	FORMAT	DEFAULT
0320	RTD #12 PICKUP	0 to 4	1	–	F123	0
0321	OPEN SENSOR PICKUP	0 to 4	1	–	F123	0
0322	SHORT/LOW TEMP PICKUP	0 to 4	1	–	F123	0
0323	THERMAL MODEL PICKUP	0 to 4	1	–	F123	0
0324	TRIP COUNTER PICKUP	0 to 4	1	–	F123	0
0325	BREAKER FAILURE PICKUP	0 to 4	1	–	F123	0
0326	TRIP COIL MONITOR PICKUP	0 to 4	1	–	F123	0
0327	VT FUSE FAILURE PICKUP	0 to 4	1	–	F123	0
0328	CURRENT DEMAND PICKUP	0 to 4	1	–	F123	0
0329	MW DEMAND PICKUP	0 to 4	1	–	F123	0
032A	Mvar DEMAND PICKUP	0 to 4	1	–	F123	0
032B	MVA DEMAND PICKUP	0 to 4	1	–	F123	0
032C	ANALOG INPUT 1 PICKUP	0 to 4	1	–	F123	0
032D	ANALOG INPUT 2 PICKUP	0 to 4	1	–	F123	0
032E	ANALOG INPUT 3 PICKUP	0 to 4	1	–	F123	0
032F	ANALOG INPUT 4 PICKUP	0 to 4	1	–	F123	0
0330	NOT PROGRAMMED PICKUP	0 to 4	1	–	F123	0
0331	SIMULATION MODE PICKUP	0 to 4	1	–	F123	0
0332	OUTPUT RELAYS FORCED PICKUP	0 to 4	1	–	F123	0
0333	ANALOG OUTPUT FORCED PICKUP	0 to 4	1	–	F123	0
0334	TEST SWITCH SHORTED PICKUP	0 to 4	1	–	F123	0
0335	GROUND DIRECTIONAL PICKUP	0 to 4	1	–	F123	0
0336	IRIG-B ALARM PICKUP	0 to 4	1	–	F123	0
0337	GENERATOR RUNNING HOUR PICKUP	0 to 4	1	–	F123	0
STATUS / DIGITAL INPUTS						
0380	ACCESS SWITCH STATE	0 to 1	1	–	F207	0
0381	BREAKER STATUS SWITCH STATE	0 to 1	1	–	F207	0
0382	ASSIGNABLE DIGITAL INPUT1 STATE	0 to 1	1	–	F207	0
0383	ASSIGNABLE DIGITAL INPUT2 STATE	0 to 1	1	–	F207	0
0384	ASSIGNABLE DIGITAL INPUT3 STATE	0 to 1	1	–	F207	0
0385	ASSIGNABLE DIGITAL INPUT4 STATE	0 to 1	1	–	F207	0
0386	ASSIGNABLE DIGITAL INPUT5 STATE	0 to 1	1	–	F207	0
0387	ASSIGNABLE DIGITAL INPUT6 STATE	0 to 1	1	–	F207	0
0388	ASSIGNABLE DIGITAL INPUT7 STATE	0 to 1	1	–	F207	0
0389	TRIP COIL SUPERVISION	0 to 1	1	–	F132	0
STATUS / REAL TIME CLOCK						
03FC	DATE (READ-ONLY)	N/A	N/A	N/A	F18	N/A
03FE	TIME (READ-ONLY)	N/A	N/A	N/A	F19	N/A
METERING DATA / CURRENT METERING						
0400	PHASE A OUTPUT CURRENT	0 to 999999	1	Amps	F12	0
0402	PHASE B OUTPUT CURRENT	0 to 999999	1	Amps	F12	0
0404	PHASE C OUTPUT CURRENT	0 to 999999	1	Amps	F12	0
0406	PHASE A NEUTRAL-SIDE CURRENT	0 to 999999	1	Amps	F12	0
0408	PHASE B NEUTRAL-SIDE CURRENT	0 to 999999	1	Amps	F12	0
040A	PHASE C NEUTRAL-SIDE CURRENT	0 to 999999	1	Amps	F12	0
040C	PHASE A DIFFERENTIAL CURRENT	0 to 999999	1	Amps	F12	0
040E	PHASE B DIFFERENTIAL CURRENT	0 to 999999	1	Amps	F12	0
0410	PHASE C DIFFERENTIAL CURRENT	0 to 999999	1	Amps	F12	0
0412	AVERAGE PHASE CURRENT	0 to 999999	1	Amps	F12	0
0414	GENERATOR LOAD	0 to 2000	1	% FLA	F1	0
0415	NEGATIVE SEQUENCE CURRENT	0 to 2000	1	% FLA	F1	0
0416	GROUND CURRENT	0 to 10000	1	Amps	F14	0
0420	PHASE A CURRENT ANGLE	0 to 359	1	°	F1	0

1, 2, 3 See Table footnotes on page 6–39

Table 6–1: 489 MEMORY MAP (Sheet 5 of 29)

ADDR	NAME	RANGE	STEP	UNITS	FORMAT	DEFAULT
0421	PHASE B CURRENT ANGLE	0 to 359	1	°	F1	0
0422	PHASE A CURRENT ANGLE	0 to 359	1	°	F1	0
0423	PHASE A NEUTRAL-SIDE ANGLE	0 to 359	1	°	F1	0
0424	PHASE B NEUTRAL-SIDE ANGLE	0 to 359	1	°	F1	0
0425	PHASE C NEUTRAL-SIDE ANGLE	0 to 359	1	°	F1	0
0426	PHASE A DIFFERENTIAL ANGLE	0 to 359	1	°	F1	0
0427	PHASE B DIFFERENTIAL ANGLE	0 to 359	1	°	F1	0
0428	PHASE C DIFFERENTIAL ANGLE	0 to 359	1	°	F1	0
0429	GROUND CURRENT ANGLE	0 to 359	1	°	F1	0
METERING DATA / VOLTAGE METERING						
0440	PHASE A-B VOLTAGE	0 to 50000	1	Volts	F1	0
0441	PHASE B-C VOLTAGE	0 to 50000	1	Volts	F1	0
0442	PHASE C-A VOLTAGE	0 to 50000	1	Volts	F1	0
0443	AVERAGE LINE VOLTAGE	0 to 50000	1	Volts	F1	0
0444	PHASE A-N VOLTAGE	0 to 50000	1	Volts	F1	0
0445	PHASE B-N VOLTAGE	0 to 50000	1	Volts	F1	0
0446	PHASE C-N VOLTAGE	0 to 50000	1	Volts	F1	0
0447	AVERAGE PHASE VOLTAGE	0 to 50000	1	Volts	F1	0
0448	PER UNIT MEASUREMENT OF V/Hz ²	0 to 200	1	–	F3	0
0449	FREQUENCY	500 to 9000	1	Hz	F3	0
044A	NEUTRAL VOLTAGE FUND	0 to 250000	1	Volts	F10	0
044C	NEUTRAL VOLTAGE 3rd HARM	0 to 250000	1	Volts	F10	0
044E	NEUTRAL VOLTAGE Vp3 3rd HARM	0 to 250000	1	Volts	F10	0
0450	Vab/lab	0 to 65535	1	ohms	F2	0
0451	Vab/lab ANGLE	0 to 359	1	°	F1	0
0460	LINE A-B VOLTAGE ANGLE	0 to 359	1	°	F1	0
0461	LINE B-C VOLTAGE ANGLE	0 to 359	1	°	F1	0
0462	LINE C-A VOLTAGE ANGLE	0 to 359	1	°	F1	0
0463	PHASE A-N VOLTAGE ANGLE	0 to 359	1	°	F1	0
0464	PHASE B-N VOLTAGE ANGLE	0 to 359	1	°	F1	0
0465	PHASE C-N VOLTAGE ANGLE	0 to 359	1	°	F1	0
0466	NEUTRAL VOLTAGE ANGLE	0 to 359	1	–	F1	0
METERING DATA / POWER METERING						
0480	POWER FACTOR	–100 to 100	1	–	F6	0
0481	REAL POWER	–2000000 to 2000000	1	MW	F13	0
0483	REACTIVE POWER	–2000000 to 2000000	1	Mvar	F13	0
0485	APPARENT POWER	–2000000 to 2000000	1	MVA	F13	0
0487	POSITIVE WATTHOURS	0 to 4000000000	1	MWh	F13	0
0489	POSITIVE VARHOURS	0 to 4000000000	1	Mvarh	F13	0
048B	NEGATIVE VARHOURS	0 to 4000000000	1	Mvarh	F13	0
METERING DATA / TEMPERATURE						
04A0	HOTTEST STATOR RTD	1 to 12	1	–	F1	0
04A1	HOTTEST STATOR RTD TEMPERATURE	–52 to 250	1	°C	F4	–52
04A2	RTD #1 TEMPERATURE	–52 to 251	1	°C	F4	–52
04A3	RTD #2 TEMPERATURE	–52 to 251	1	°C	F4	–52
04A4	RTD #3 TEMPERATURE	–52 to 251	1	°C	F4	–52
04A5	RTD #4 TEMPERATURE	–52 to 251	1	°C	F4	–52
04A6	RTD #5 TEMPERATURE	–52 to 251	1	°C	F4	–52
04A7	RTD #6 TEMPERATURE	–52 to 251	1	°C	F4	–52
04A8	RTD #7 TEMPERATURE	–52 to 251	1	°C	F4	–52
04A9	RTD #8 TEMPERATURE	–52 to 251	1	°C	F4	–52
04AA	RTD #9 TEMPERATURE	–52 to 251	1	°C	F4	–52
04AB	RTD #10 TEMPERATURE	–52 to 251	1	°C	F4	–52

1, 2, 3 See Table footnotes on page 6–39

Table 6–1: 489 MEMORY MAP (Sheet 6 of 29)

ADDR	NAME	RANGE	STEP	UNITS	FORMAT	DEFAULT
04AC	RTD #11 TEMPERATURE	-52 to 251	1	°C	F4	-52
04AD	RTD #12 TEMPERATURE	-52 to 251	1	°C	F4	-52
04C0	HOTTEST STATOR RTD TEMPERATURE	-52 to 250	1	°F	F4	-52
04C1	RTD #1 TEMPERATURE	-52 to 251	1	°F	F4	-52
04C2	RTD #2 TEMPERATURE	-52 to 251	1	°F	F4	-52
04C3	RTD #3 TEMPERATURE	-52 to 251	1	°F	F4	-52
04C4	RTD #4 TEMPERATURE	-52 to 251	1	°F	F4	-52
04C5	RTD #5 TEMPERATURE	-52 to 251	1	°F	F4	-52
04C6	RTD #6 TEMPERATURE	-52 to 251	1	°F	F4	-52
04C7	RTD #7 TEMPERATURE	-52 to 251	1	°F	F4	-52
04C8	RTD #8 TEMPERATURE	-52 to 251	1	°F	F4	-52
04C9	RTD #9 TEMPERATURE	-52 to 251	1	°F	F4	-52
04CA	RTD #10 TEMPERATURE	-52 to 251	1	°F	F4	-52
04CB	RTD #11 TEMPERATURE	-52 to 251	1	°F	F4	-52
04CC	RTD #12 TEMPERATURE	-52 to 251	1	°F	F4	-52
METERING DATA / DEMAND METERING						
04E0	CURRENT DEMAND	0 to 1000000	1	Amps	F12	0
04E2	MW DEMAND	0 to 2000000	1	MW	F13	0
04E4	Mvar DEMAND	0 to 2000000	1	Mvar	F13	0
04E6	MVA DEMAND	0 to 2000000	1	MVA	F13	0
04E8	PEAK CURRENT DEMAND	0 to 1000000	1	Amps	F12	0
04EA	PEAK MW DEMAND	0 to 2000000	1	MW	F13	0
04EC	PEAK Mvar DEMAND	0 to 2000000	1	Mvar	F13	0
04EE	PEAK MVA DEMAND	0 to 2000000	1	MVA	F13	0
METERING DATA / ANALOG INPUTS						
0500	ANALOG INPUT 1	-50000 to 50000	1	Units	F12	0
0502	ANALOG INPUT 2	-50000 to 50000	1	Units	F12	0
0504	ANALOG INPUT 3	-50000 to 50000	1	Units	F12	0
0506	ANALOG INPUT 4	-50000 to 50000	1	Units	F12	0
METERING DATA / SPEED						
0520	TACHOMETER	0 to 7200	1	RPM	F1	0
LEARNED DATA / PARAMETER AVERAGES						
0600	AVERAGE GENERATOR LOAD	0 to 2000	1	%FLA	F1	0
0601	AVERAGE NEG. SEQ. CURRENT	0 to 2000	1	%FLA	F1	0
0602	AVERAGE PHASE-PHASE VOLTAGE	0 to 50000	1	V	F1	0
0603	RESERVED	-	-	-	-	-
0604	RESERVED	-	-	-	-	-
LEARNED DATA / RTD MAXIMUMS						
0620	RTD #1 MAX. TEMP.	-52 to 251	1	°C	F4	-52
0621	RTD #2 MAX. TEMP.	-52 to 251	1	°C	F4	-52
0622	RTD #3 MAX. TEMP.	-52 to 251	1	°C	F4	-52
0623	RTD #4 MAX. TEMP.	-52 to 251	1	°C	F4	-52
0624	RTD #5 MAX. TEMP.	-52 to 251	1	°C	F4	-52
0625	RTD #6 MAX. TEMP.	-52 to 251	1	°C	F4	-52
0626	RTD #7 MAX. TEMP.	-52 to 251	1	°C	F4	-52
0627	RTD #8 MAX. TEMP.	-52 to 251	1	°C	F4	-52
0628	RTD #9 MAX. TEMP.	-52 to 251	1	°C	F4	-52
0629	RTD #10 MAX. TEMP.	-52 to 251	1	°C	F4	-52
062A	RTD #11 MAX. TEMP.	-52 to 251	1	°C	F4	-52
062B	RTD #12 MAX. TEMP.	-52 to 251	1	°C	F4	-52
0640	RTD #1 MAX. TEMP.	-52 to 251	1	°F	F4	-52
0641	RTD #2 MAX. TEMP.	-52 to 251	1	°F	F4	-52
0642	RTD #3 MAX. TEMP.	-52 to 251	1	°F	F4	-52

1, 2, 3 See Table footnotes on page 6–39

Table 6–1: 489 MEMORY MAP (Sheet 7 of 29)

ADDR	NAME	RANGE	STEP	UNITS	FORMAT	DEFAULT
0643	RTD #4 MAX. TEMP.	-52 to 251	1	°F	F4	-52
0644	RTD #5 MAX. TEMP.	-52 to 251	1	°F	F4	-52
0645	RTD #6 MAX. TEMP.	-52 to 251	1	°F	F4	-52
0646	RTD #7 MAX. TEMP.	-52 to 251	1	°F	F4	-52
0647	RTD #8 MAX. TEMP.	-52 to 251	1	°F	F4	-52
0648	RTD #9 MAX. TEMP.	-52 to 251	1	°F	F4	-52
0649	RTD #10 MAX. TEMP.	-52 to 251	1	°F	F4	-52
064A	RTD #11 MAX. TEMP.	-52 to 251	1	°F	F4	-52
064B	RTD #12 MAX. TEMP.	-52 to 251	1	°F	F4	-52
LEARNED DATA / ANALOG IN MIN/MAX						
0700	ANALOG INPUT 1 MINIMUM	-50000 to 50000	1	Units	F12	0
0702	ANALOG INPUT 1 MAXIMUM	-50000 to 50000	1	Units	F12	0
0704	ANALOG INPUT 2 MINIMUM	-50000 to 50000	1	Units	F12	0
0706	ANALOG INPUT 2 MAXIMUM	-50000 to 50000	1	Units	F12	0
0708	ANALOG INPUT 3 MINIMUM	-50000 to 50000	1	Units	F12	0
070A	ANALOG INPUT 3 MAXIMUM	-50000 to 50000	1	Units	F12	0
070C	ANALOG INPUT 4 MINIMUM	-50000 to 50000	1	Units	F12	0
070E	ANALOG INPUT 4 MAXIMUM	-50000 to 50000	1	Units	F12	0
MAINTENANCE / TRIP COUNTERS						
077F	TRIP COUNTERS LAST CLEARED (DATE)	N/A	N/A	N/A	F18	N/A
0781	TOTAL NUMBER OF TRIPS	0 to 50000	1	-	F1	0
0782	DIGITAL INPUT TRIPS	0 to 50000	1	-	F1	0
0783	SEQUENTIAL TRIPS	0 to 50000	1	-	F1	0
0784	FIELD-BKR DISCREP. TRIPS	0 to 50000	1	-	F1	0
0785	TACHOMETER TRIPS	0 to 50000	1	-	F1	0
0786	OFFLINE OVERCURRENT TRIPS	0 to 50000	1	-	F1	0
0787	PHASE OVERCURRENT TRIPS	0 to 50000	1	-	F1	0
0788	NEG.SEQ. OVERCURRENT TRIPS	0 to 50000	1	-	F1	0
0789	GROUND OVERCURRENT TRIPS	0 to 50000	1	-	F1	0
078A	PHASE DIFFERENTIAL TRIPS	0 to 50000	1	-	F1	0
078B	UNDERVOLTAGE TRIPS	0 to 50000	1	-	F1	0
078C	OVERVOLTAGE TRIPS	0 to 50000	1	-	F1	0
078D	VOLTS/HERTZ TRIPS	0 to 50000	1	-	F1	0
078E	PHASE REVERSAL TRIPS	0 to 50000	1	-	F1	0
078F	UNDERFREQUENCY TRIPS	0 to 50000	1	-	F1	0
0790	OVERFREQUENCY TRIPS	0 to 50000	1	-	F1	0
0791	NEUTRAL O/V (FUND) TRIPS	0 to 50000	1	-	F1	0
0792	NEUTRAL U/V (3rd) TRIPS	0 to 50000	1	-	F1	0
0793	REACTIVE POWER TRIPS	0 to 50000	1	-	F1	0
0794	REVERSE POWER TRIPS	0 to 50000	1	-	F1	0
0795	LOW FORWARD POWER TRIPS	0 to 50000	1	-	F1	0
0796	STATOR RTD TRIPS	0 to 50000	1	-	F1	0
0797	BEARING RTD TRIPS	0 to 50000	1	-	F1	0
0798	OTHER RTD TRIPS	0 to 50000	1	-	F1	0
0799	AMBIENT RTD TRIPS	0 to 50000	1	-	F1	0
079A	THERMAL MODEL TRIPS	0 to 50000	1	-	F1	0
079B	INADVERTENT ENERG. TRIPS	0 to 50000	1	-	F1	0
079C	ANALOG INPUT 1 TRIPS	0 to 50000	1	-	F1	0
079D	ANALOG INPUT 2 TRIPS	0 to 50000	1	-	F1	0
079E	ANALOG INPUT 3 TRIPS	0 to 50000	1	-	F1	0
079F	ANALOG INPUT 4 TRIPS	0 to 50000	1	-	F1	0
MAINTENANCE / GENERAL COUNTERS						
07A0	NUMBER OF BREAKER OPERATIONS	0 to 50000	1	-	F1	0

1, 2, 3 See Table footnotes on page 6–39

Table 6–1: 489 MEMORY MAP (Sheet 8 of 29)

ADDR	NAME	RANGE	STEP	UNITS	FORMAT	DEFAULT
07A1	NUMBER OF THERMAL RESETS	0 to 50000	1	–	F1	0
MAINTENANCE / TRIP COUNTERS						
07A2	LOSS OF EXCITATION 1 TRIPS	0 to 50000	1	–	F1	0
07A3	LOSS OF EXCITATION 2 TRIPS	0 to 50000	1	–	F1	0
07A4	GROUND DIRECTIONAL TRIPS	0 to 50000	1	–	F1	0
07A5	HIGH-SET PHASE O/C TRIPS	0 to 50000	1	–	F1	0
07A6	DISTANCE ZONE 1 TRIPS	0 to 50000	1	–	F1	0
07A7	DISTANCE ZONE 2 TRIPS	0 to 50000	1	–	F1	0
MAINTENANCE / TIMERS						
07E0	GENERATOR HOURS ONLINE	0 to 1000000	1	h	F12	0
PRODUCT INFO. / 489 MODEL INFO.						
0800	ORDER CODE	0 to 65535	1	N/A	F136	N/A
0801	489 SERIAL NUMBER	3000000 to 9999999	1	–	F12	3000000
PRODUCT INFO. / CALIBRATION INFO.						
0810	ORIGINAL CALIBRATION DATE	N/A	N/A	N/A	F18	N/A
0812	LAST CALIBRATION DATE	N/A	N/A	N/A	F18	N/A
489 SETUP / PREFERENCES						
1000	DEFAULT MESSAGE CYCLE TIME	5 to 100	5	s	F2	20
1001	DEFAULT MESSAGE TIMEOUT	10 to 900	1	s	F1	300
1003	PARAMETER AVERAGES CALC. PERIOD	1 to 90	1	min	F1	15
1004	TEMPERATURE DISPLAY	0 to 1	1	–	F100	0
1005	WAVEFORM TRIGGER POSITION	1 to 100	1	%	F1	25
1006	PASSCODE (WRITE ONLY)	0 to 99999999	1	N/A	F12	0
1008	ENCRYPTED PASSCODE (READ ONLY)	N/A	N/A	N/A	F12	N/A
100A	WAVEFORM MEMORY BUFFER	1 to 16	1	–	F1	8
489 SETUP / SERIAL PORTS						
1010	SLAVE ADDRESS	1 to 254	1	–	F1	254
1011	COMPUTER RS485 BAUD RATE	0 to 5	1	–	F101	4
1012	COMPUTER RS485 PARITY	0 to 2	1	–	F102	0
1013	AUXILIARY RS485 BAUD RATE	0 to 5	1	–	F101	4
1014	AUXILIARY RS485 PARITY	0 to 2	1	–	F102	0
1015	PORT USED FOR DNP	0 to 3	1	–	F216	0
1016	DNP SLAVE ADDRESS	0 to 255	1	–	F1	255
1017	DNP TURNAROUND TIME	0 to 100	10	ms	F1	10
489 SETUP / REAL TIME CLOCK						
1030	DATE	N/A	N/A	N/A	F18	N/A
1032	TIME	N/A	N/A	N/A	F19	N/A
1034	IRIG-B TYPE	0 to 2	1	–	F220	0
489 SETUP / MESSAGE SCRATCHPAD						
1060	Scratchpad	0 to 40	1	–	F22	–
1080	Scratchpad	0 to 40	1	–	F22	–
10A0	Scratchpad	0 to 40	1	–	F22	–
10C0	Scratchpad	0 to 40	1	–	F22	–
10E0	Scratchpad	0 to 40	1	–	F22	–
489 SETUP / CLEAR DATA						
1130	CLEAR LAST TRIP DATA	0 to 1	1	–	F103	0
1131	CLEAR MWh and Mvarh METERS	0 to 1	1	–	F103	0
1132	CLEAR PEAK DEMAND DATA	0 to 1	1	–	F103	0
1133	CLEAR RTD MAXIMUMS	0 to 1	1	–	F103	0
1134	CLEAR ANALOG I/P MIN/MAX	0 to 1	1	–	F103	0
1135	CLEAR TRIP COUNTERS	0 to 1	1	–	F103	0
1136	CLEAR EVENT RECORD	0 to 1	1	–	F103	0
1137	CLEAR GENERATOR INFORMATION	0 to 1	1	–	F103	0

1, 2, 3 See Table footnotes on page 6–39

Table 6–1: 489 MEMORY MAP (Sheet 9 of 29)

ADDR	NAME	RANGE	STEP	UNITS	FORMAT	DEFAULT
1138	CLEAR BREAKER INFORMATION	0 to 1	1	–	F103	0
SYSTEM SETUP / CURRENT SENSING						
1180	PHASE CT PRIMARY	10 to 50001	1	Amps	F1	50001
1181	GROUND CT	0 to 3	1	–	F104	0
1182	GROUND CT RATIO	10 to 10000	1	: 1 / :5	F1	100
SYSTEM SETUP / VOLTAGE SENSING						
11A0	VT CONNECTION TYPE	0 to 2	1	–	F106	0
11A1	VOLTAGE TRANSFORMER RATIO	100 to 30000	1	: 1	F3	500
11A2	NEUTRAL V.T. RATIO	100 to 24000	1	: 1	F3	500
11A3	NEUTRAL VOLTAGE TRANSFORMER	0 to 1	1	–	F103	0
SYSTEM SETUP / GEN. PARAMETERS						
11C0	GENERATOR RATED MVA	50 to 2000001	1	MVA	F13	2000001
11C2	GENERATOR RATED POWER FACTOR	5 to 100	1	–	F3	100
11C3	GENERATOR VOLTAGE PHASE-PHASE	100 to 30001	1	V	F1	30001
11C4	GENERATOR NOMINAL FREQUENCY	0 to 3	1	Hz	F107	0
11C5	GENERATOR PHASE SEQUENCE	0 to 2	1	–	F124	0
SYSTEM SETUP / SERIAL START/STOP						
11E0	SERIAL START/STOP INITIATION	0 to 1	1	–	F105	0
11E1	STARTUP INITIATION RELAYS (2-5)	1 to 4	1	–	F50	0
11E2	SHUTDOWN INITIATION RELAYS (1-4)	0 to 3	1	–	F50	0
11E3	SERIAL START/STOP EVENTS	0 to 1	1	–	F105	0
DIGITAL INPUTS / BREAKER STATUS						
1200	BREAKER STATUS	0 to 1	1	–	F209	1
DIGITAL INPUTS / GENERAL INPUT A						
1210	ASSIGN DIGITAL INPUT	0 to 7	1	–	F210	0
1211	ASSERTED DIGITAL INPUT STATE	0 to 1	1	–	F131	0
1212	INPUT NAME	0 to 12	1	–	F22	–
1218	BLOCK INPUT FROM ONLINE	0 to 5000	1	s	F1	0
1219	GENERAL INPUT A CONTROL	0 to 1	1	–	F105	0
121A	PULSED CONTROL RELAY DWELL TIME	0 to 250	1	s	F2	0
121B	ASSIGN CONTROL RELAYS (1-5)	0 to 4	1	–	F50	0
121C	GENERAL INPUT A CONTROL EVENTS	0 to 1	1	–	F105	0
121D	GENERAL INPUT A ALARM	0 to 2	1	–	F115	0
121E	ASSIGN ALARM RELAYS (2-5)	1 to 4	1	–	F50	16
121F	GENERAL INPUT A ALARM DELAY	1 to 50000	1	s	F2	50
1220	GENERAL INPUT A ALARM EVENTS	0 to 1	1	–	F105	0
1221	GENERAL INPUT A TRIP	0 to 2	1	–	F115	0
1222	ASSIGN TRIP RELAYS (1-4)	0 to 3	1	–	F50	1
1223	GENERAL INPUT A TRIP DELAY	1 to 50000	1	s	F2	50
DIGITAL INPUTS / GENERAL INPUT B						
1230	ASSIGN DIGITAL INPUT	0 to 7	1	–	F210	0
1231	ASSERTED DIGITAL INPUT STATE	0 to 1	1	–	F131	0
1232	INPUT NAME	0 to 12	1	–	F22	–
1238	BLOCK INPUT FROM ONLINE	0 to 5000	1	s	F1	0
1239	GENERAL INPUT B CONTROL	0 to 1	1	–	F105	0
123A	PULSED CONTROL RELAY DWELL TIME	0 to 250	1	s	F2	0
123B	ASSIGN CONTROL RELAYS (1-5)	0 to 4	1	–	F50	0
123C	GENERAL INPUT B CONTROL EVENTS	0 to 1	1	–	F105	0
123D	GENERAL INPUT B ALARM	0 to 2	1	–	F115	0
123E	ASSIGN ALARM RELAYS (2-5)	1 to 4	1	–	F50	16
123F	GENERAL INPUT B ALARM DELAY	1 to 50000	1	s	F2	50
1240	GENERAL INPUT B ALARM EVENTS	0 to 1	1	–	F105	0
1241	GENERAL INPUT B TRIP	0 to 2	1	–	F115	0

1, 2, 3 See Table footnotes on page 6–39

Table 6–1: 489 MEMORY MAP (Sheet 10 of 29)

ADDR	NAME	RANGE	STEP	UNITS	FORMAT	DEFAULT
1242	ASSIGN TRIP RELAYS (1-4)	0 to 3	1	–	F50	1
1243	GENERAL INPUT B TRIP DELAY	1 to 50000	1	s	F2	50
DIGITAL INPUTS / GENERAL INPUT C						
1250	ASSIGN DIGITAL INPUT	0 to 7	1	–	F210	0
1251	ASSERTED DIGITAL INPUT STATE	0 to 1	1	–	F131	0
1252	INPUT NAME	0 to 12	1	–	F22	–
1258	BLOCK INPUT FROM ONLINE	0 to 5000	1	s	F1	0
1259	GENERAL INPUT C CONTROL	0 to 1	1	–	F105	0
125A	PULSED CONTROL RELAY DWELL TIME	0 to 250	1	s	F2	0
125B	ASSIGN CONTROL RELAYS (1-5)	0 to 4	1	–	F50	0
125C	GENERAL INPUT C CONTROL EVENTS	0 to 1	1	–	F105	0
125D	GENERAL INPUT C ALARM	0 to 2	1	–	F115	0
125E	ASSIGN ALARM RELAYS (2-5)	1 to 4	1	–	F50	16
125F	GENERAL INPUT C ALARM DELAY	1 to 50000	1	s	F2	50
1260	GENERAL INPUT C ALARM EVENTS	0 to 1	1	–	F105	0
1261	GENERAL INPUT C TRIP	0 to 2	1	–	F115	0
1262	ASSIGN TRIP RELAYS (1-4)	0 to 3	1	–	F50	1
1263	GENERAL INPUT C TRIP DELAY	1 to 50000	1	s	F2	50
DIGITAL INPUTS / GENERAL INPUT D						
1270	ASSIGN DIGITAL INPUT	0 to 7	1	–	F210	0
1271	ASSERTED DIGITAL INPUT STATE	0 to 1	1	–	F131	0
1272	INPUT NAME	0 to 12	1	–	F22	–
1278	BLOCK INPUT FROM ONLINE	0 to 5000	1	s	F1	0
1279	GENERAL INPUT D CONTROL	0 to 1	1	–	F105	0
127A	PULSED CONTROL RELAY DWELL TIME	0 to 250	1	s	F2	0
127B	ASSIGN CONTROL RELAYS (1-5)	0 to 4	1	–	F50	0
127C	GENERAL INPUT D CONTROL EVENTS	0 to 1	1	–	F105	0
127D	GENERAL INPUT D ALARM	0 to 2	1	–	F115	0
127E	ASSIGN ALARM RELAYS (2-5)	1 to 4	1	–	F50	16
127F	GENERAL INPUT D ALARM DELAY	1 to 50000	1	s	F2	50
1280	GENERAL INPUT D ALARM EVENTS	0 to 1	1	–	F105	0
1281	GENERAL INPUT D TRIP	0 to 2	1	–	F115	0
1282	ASSIGN TRIP RELAYS (1-4)	0 to 3	1	–	F50	1
1283	GENERAL INPUT D TRIP DELAY	1 to 50000	1	s	F2	50
DIGITAL INPUTS / GENERAL INPUT E						
1290	ASSIGN DIGITAL INPUT	0 to 7	1	–	F210	0
1291	ASSERTED DIGITAL INPUT STATE	0 to 1	1	–	F131	0
1292	INPUT NAME	0 to 12	1	–	F22	–
1298	BLOCK INPUT FROM ONLINE	0 to 5000	1	s	F1	0
1299	GENERAL INPUT E CONTROL	0 to 1	1	–	F105	0
129A	PULSED CONTROL RELAY DWELL TIME	0 to 250	1	s	F2	0
129B	ASSIGN CONTROL RELAYS (1-5)	0 to 4	1	–	F50	0
129C	GENERAL INPUT E CONTROL EVENTS	0 to 1	1	–	F105	0
129D	GENERAL INPUT E ALARM	0 to 2	1	–	F115	0
129E	ASSIGN ALARM RELAYS (2-5)	1 to 4	1	–	F50	16
129F	GENERAL INPUT E ALARM DELAY	1 to 50000	1	s	F2	50
12A0	GENERAL INPUT E ALARM EVENTS	0 to 1	1	–	F105	0
12A1	GENERAL INPUT E TRIP	0 to 2	1	–	F115	0
12A2	ASSIGN TRIP RELAYS (1-4)	0 to 3	1	–	F50	1
12A3	GENERAL INPUT E TRIP DELAY	1 to 50000	1	s	F2	50
DIGITAL INPUTS / GENERAL INPUT F						
12B0	ASSIGN DIGITAL INPUT	0 to 7	1	–	F210	0
12B1	ASSERTED DIGITAL INPUT STATE	0 to 1	1	–	F131	0

1, 2, 3 See Table footnotes on page 6–39

Table 6–1: 489 MEMORY MAP (Sheet 11 of 29)

ADDR	NAME	RANGE	STEP	UNITS	FORMAT	DEFAULT
12B2	INPUT NAME	0 to 12	1	–	F22	–
12B8	BLOCK INPUT FROM ONLINE	0 to 5000	1	s	F1	0
12B9	GENERAL INPUT F CONTROL	0 to 1	1	–	F105	0
12BA	PULSED CONTROL RELAY DWELL TIME	0 to 250	1	s	F2	0
12BB	ASSIGN CONTROL RELAYS (1-5)	0 to 4	1	–	F50	0
12BC	GENERAL INPUT F CONTROL EVENTS	0 to 1	1	–	F105	0
12BD	GENERAL INPUT F ALARM	0 to 2	1	–	F115	0
12BE	ASSIGN ALARM RELAYS (2-5)	1 to 4	1	–	F50	16
12BF	GENERAL INPUT F ALARM DELAY	1 to 50000	1	s	F2	50
12C0	GENERAL INPUT F ALARM EVENTS	0 to 1	1	–	F105	0
12C1	GENERAL INPUT F TRIP	0 to 2	1	–	F115	0
12C2	ASSIGN TRIP RELAYS (1-4)	0 to 3	1	–	F50	1
12C3	GENERAL INPUT F TRIP DELAY	1 to 50000	1	s	F2	50
DIGITAL INPUTS / GENERAL INPUT G						
12D0	ASSIGN DIGITAL INPUT	0 to 7	1	–	F210	0
12D1	ASSERTED DIGITAL INPUT STATE	0 to 1	1	–	F131	0
12D2	INPUT NAME	0 to 12	1	–	F22	–
12D8	BLOCK INPUT FROM ONLINE	0 to 5000	1	s	F1	0
12D9	GENERAL INPUT G CONTROL	0 to 1	1	–	F105	0
12DA	PULSED CONTROL RELAY DWELL TIME	0 to 250	1	s	F2	0
12DB	ASSIGN CONTROL RELAYS (1-5)	0 to 4	1	–	F50	0
12DC	GENERAL INPUT G CONTROL EVENTS	0 to 1	1	–	F105	0
12DD	GENERAL INPUT G ALARM	0 to 2	1	–	F115	0
12DE	ASSIGN ALARM RELAYS (2-5)	1 to 4	1	–	F50	16
12DF	GENERAL INPUT G ALARM DELAY	1 to 50000	1	s	F2	50
12E0	GENERAL INPUT G ALARM EVENTS	0 to 1	1	–	F105	0
12E1	GENERAL INPUT G TRIP	0 to 2	1	–	F115	0
12E2	ASSIGN TRIP RELAYS (1-4)	0 to 3	1	–	F50	1
12E3	GENERAL INPUT G TRIP DELAY	1 to 50000	1	s	F2	50
DIGITAL INPUTS / REMOTE RESET						
1300	ASSIGN DIGITAL INPUT	0 to 7	1	–	F210	0
DIGITAL INPUTS / TEST INPUT						
1310	ASSIGN DIGITAL INPUT	0 to 7	1	–	F210	0
DIGITAL INPUTS / THERMAL RESET						
1320	ASSIGN DIGITAL INPUT	0 to 7	1	–	F210	0
DIGITAL INPUTS / DUAL SETPOINTS						
1340	ASSIGN DIGITAL INPUT	0 to 7	1	–	F210	0
1341	ACTIVE SETPOINT GROUP	0 to 1	1	–	F118	0
1342	EDIT SETPOINT GROUP	0 to 1	1	–	F118	0
DIGITAL INPUTS / SEQUENTIAL TRIP						
1360	ASSIGN DIGITAL INPUT	0 to 7	1	–	F210	0
1361	SEQUENTIAL TRIP TYPE	0 to 1	1	–	F206	0
1362	ASSIGN TRIP RELAYS (1-4)	0 to 3	1	–	F50	1
1363	SEQUENTIAL TRIP LEVEL	2 to 99	1	× Rated MW	F14	5
1365	SEQUENTIAL TRIP DELAY	2 to 1200	1	s	F2	10
DIGITAL INPUTS / FIELD-BKR DISCREP.						
1380	ASSIGN DIGITAL INPUT	0 to 7	1	–	F210	0
1381	FIELD STATUS CONTACT	0 to 1	1	–	F109	0
1382	ASSIGN TRIP RELAYS (1-4)	0 to 3	1	–	F50	1
1383	FIELD-BKR DISCREP. TRIP DELAY	1 to 5000	1	s	F2	10
DIGITAL INPUTS / TACHOMETER						
13A0	ASSIGN DIGITAL INPUT	0 to 7	1	–	F210	0
13A1	RATED SPEED	100 to 3600	1	RPM	F1	3600

1, 2, 3 See Table footnotes on page 6–39

Table 6–1: 489 MEMORY MAP (Sheet 12 of 29)

ADDR	NAME	RANGE	STEP	UNITS	FORMAT	DEFAULT
13A2	TACHOMETER ALARM	0 to 2	1	–	F115	0
13A3	ASSIGN ALARM RELAYS (2-5)	1 to 4	1	–	F50	16
13A4	TACHOMETER ALARM SPEED	101 to 175	1	%Rated	F1	110
13A5	TACHOMETER ALARM DELAY	1 to 250	1	s	F1	1
13A6	TACHOMETER ALARM EVENTS	0 to 1	1	–	F105	0
13A7	TACHOMETER TRIP	0 to 2	1	–	F115	0
13A8	ASSIGN TRIP RELAYS (1-4)	0 to 3	1	–	F50	1
13A9	TACHOMETER TRIP SPEED	101 to 175	1	%Rated	F1	110
13AA	TACHOMETER TRIP DELAY	1 to 250	1	s	F1	1
DIGITAL INPUTS / WAVEFORM CAPTURE						
13C0	ASSIGN DIGITAL INPUT	0 to 7	1	–	F210	0
DIGITAL INPUTS / GND. SWITCH STATUS						
13D0	ASSIGN DIGITAL INPUT	0 to 7	1	–	F210	0
13D1	GROUND SWITCH CONTACT	0 to 1	1	–	F109	0
OUTPUT RELAYS / RELAY RESET MODE						
1400	R1 TRIP	0 to 1	1	–	F117	0
1401	R2 AUXILIARY	0 to 1	1	–	F117	0
1402	R3 AUXILIARY	0 to 1	1	–	F117	0
1403	R4 AUXILIARY	0 to 1	1	–	F117	0
1404	R5 ALARM	0 to 1	1	–	F117	0
1405	R6 SERVICE	0 to 1	1	–	F117	0
CURRENT ELEMENTS / OVERCURRENT ALARM						
1500	OVERCURRENT ALARM	0 to 2	1	–	F115	0
1501	ASSIGN ALARM RELAYS (2-5)	1 to 4	1	–	F50	16
1502	OVERCURRENT ALARM LEVEL	10 to 150	1	× FLA	F3	101
1503	OVERCURRENT ALARM DELAY	1 to 2500	1	s	F2	1
1504	OVERCURRENT ALARM EVENTS	0 to 1	1	–	F105	0
CURRENT ELEMENTS / OFFLINE O/C						
1520	OFFLINE OVERCURRENT TRIP	0 to 2	1	–	F115	0
1521	ASSIGN TRIP RELAYS (1-4)	0 to 3	1	–	F50	1
1522	OFFLINE OVERCURRENT PICKUP	5 to 100	1	× CT	F3	5
1523	OFFLINE OVERCURRENT TRIP DELAY	3 to 99	1	Cycles	F1	5
CURRENT ELEMENTS / INADVERTENT ENERG.						
1540	INADVERTENT ENERGIZE TRIP	0 to 2	1	–	F115	0
1541	ASSIGN TRIP RELAYS (1-4)	0 to 3	1	–	F50	1
1542	ARMING SIGNAL	0 to 1	1	–	F202	0
1543	INADVERTENT ENERGIZE O/C PICKUP	5 to 300	1	× CT	F3	5
1544	INADVERTENT ENERGIZE PICKUP	50 to 99	1	× Rated V	F3	50
CURRENT ELEMENTS / PHASE OVERCURRENT						
1600	PHASE OVERCURRENT TRIP	0 to 2	1	–	F115	0
1601	ASSIGN TRIP RELAYS (1-4)	0 to 3	1	–	F50	1
1602	ENABLE VOLTAGE RESTRAINT	0 to 1	1	–	F103	0
1603	PHASE OVERCURRENT PICKUP	15 to 2000	1	× CT	F3	1000
1604	CURVE SHAPE	0 to 13	1	–	F128	0
1605	FLEXCURVE TRIP TIME AT 1.03 × PU	0 to 65535	1	ms	F1	65535
1606	FLEXCURVE TRIP TIME AT 1.05 × PU	0 to 65535	1	ms	F1	65535
1607	FLEXCURVE TRIP TIME AT 1.10 × PU	0 to 65535	1	ms	F1	65535
1608	FLEXCURVE TRIP TIME AT 1.20 × PU	0 to 65535	1	ms	F1	65535
1609	FLEXCURVE TRIP TIME AT 1.30 × PU	0 to 65535	1	ms	F1	65535
160A	FLEXCURVE TRIP TIME AT 1.40 × PU	0 to 65535	1	ms	F1	65535
160B	FLEXCURVE TRIP TIME AT 1.50 × PU	0 to 65535	1	ms	F1	65535
160C	FLEXCURVE TRIP TIME AT 1.60 × PU	0 to 65535	1	ms	F1	65535
160D	FLEXCURVE TRIP TIME AT 1.70 × PU	0 to 65535	1	ms	F1	65535

1, 2, 3 See Table footnotes on page 6–39

Table 6–1: 489 MEMORY MAP (Sheet 13 of 29)

ADDR	NAME	RANGE	STEP	UNITS	FORMAT	DEFAULT
160E	FLEXCURVE TRIP TIME AT 1.80 × PU	0 to 65535	1	ms	F1	65535
160F	FLEXCURVE TRIP TIME AT 1.90 × PU	0 to 65535	1	ms	F1	65535
1610	FLEXCURVE TRIP TIME AT 2.00 × PU	0 to 65535	1	ms	F1	65535
1611	FLEXCURVE TRIP TIME AT 2.10 × PU	0 to 65535	1	ms	F1	65535
1612	FLEXCURVE TRIP TIME AT 2.20 × PU	0 to 65535	1	ms	F1	65535
1613	FLEXCURVE TRIP TIME AT 2.30 × PU	0 to 65535	1	ms	F1	65535
1614	FLEXCURVE TRIP TIME AT 2.40 × PU	0 to 65535	1	ms	F1	65535
1615	FLEXCURVE TRIP TIME AT 2.50 × PU	0 to 65535	1	ms	F1	65535
1616	FLEXCURVE TRIP TIME AT 2.60 × PU	0 to 65535	1	ms	F1	65535
1617	FLEXCURVE TRIP TIME AT 2.70 × PU	0 to 65535	1	ms	F1	65535
1618	FLEXCURVE TRIP TIME AT 2.80 × PU	0 to 65535	1	ms	F1	65535
1619	FLEXCURVE TRIP TIME AT 2.90 × PU	0 to 65535	1	ms	F1	65535
161A	FLEXCURVE TRIP TIME AT 3.00 × PU	0 to 65535	1	ms	F1	65535
161B	FLEXCURVE TRIP TIME AT 3.10 × PU	0 to 65535	1	ms	F1	65535
161C	FLEXCURVE TRIP TIME AT 3.20 × PU	0 to 65535	1	ms	F1	65535
161D	FLEXCURVE TRIP TIME AT 3.30 × PU	0 to 65535	1	ms	F1	65535
161E	FLEXCURVE TRIP TIME AT 3.40 × PU	0 to 65535	1	ms	F1	65535
161F	FLEXCURVE TRIP TIME AT 3.50 × PU	0 to 65535	1	ms	F1	65535
1620	FLEXCURVE TRIP TIME AT 3.60 × PU	0 to 65535	1	ms	F1	65535
1621	FLEXCURVE TRIP TIME AT 3.70 × PU	0 to 65535	1	ms	F1	65535
1622	FLEXCURVE TRIP TIME AT 3.80 × PU	0 to 65535	1	ms	F1	65535
1623	FLEXCURVE TRIP TIME AT 3.90 × PU	0 to 65535	1	ms	F1	65535
1624	FLEXCURVE TRIP TIME AT 4.00 × PU	0 to 65535	1	ms	F1	65535
1625	FLEXCURVE TRIP TIME AT 4.10 × PU	0 to 65535	1	ms	F1	65535
1626	FLEXCURVE TRIP TIME AT 4.20 × PU	0 to 65535	1	ms	F1	65535
1627	FLEXCURVE TRIP TIME AT 4.30 × PU	0 to 65535	1	ms	F1	65535
1628	FLEXCURVE TRIP TIME AT 4.40 × PU	0 to 65535	1	ms	F1	65535
1629	FLEXCURVE TRIP TIME AT 4.50 × PU	0 to 65535	1	ms	F1	65535
162A	FLEXCURVE TRIP TIME AT 4.60 × PU	0 to 65535	1	ms	F1	65535
162B	FLEXCURVE TRIP TIME AT 4.70 × PU	0 to 65535	1	ms	F1	65535
162C	FLEXCURVE TRIP TIME AT 4.80 × PU	0 to 65535	1	ms	F1	65535
162D	FLEXCURVE TRIP TIME AT 4.90 × PU	0 to 65535	1	ms	F1	65535
162E	FLEXCURVE TRIP TIME AT 5.00 × PU	0 to 65535	1	ms	F1	65535
162F	FLEXCURVE TRIP TIME AT 5.10 × PU	0 to 65535	1	ms	F1	65535
1630	FLEXCURVE TRIP TIME AT 5.20 × PU	0 to 65535	1	ms	F1	65535
1631	FLEXCURVE TRIP TIME AT 5.30 × PU	0 to 65535	1	ms	F1	65535
1632	FLEXCURVE TRIP TIME AT 5.40 × PU	0 to 65535	1	ms	F1	65535
1633	FLEXCURVE TRIP TIME AT 5.50 × PU	0 to 65535	1	ms	F1	65535
1634	FLEXCURVE TRIP TIME AT 5.60 × PU	0 to 65535	1	ms	F1	65535
1635	FLEXCURVE TRIP TIME AT 5.70 × PU	0 to 65535	1	ms	F1	65535
1636	FLEXCURVE TRIP TIME AT 5.80 × PU	0 to 65535	1	ms	F1	65535
1637	FLEXCURVE TRIP TIME AT 5.90 × PU	0 to 65535	1	ms	F1	65535
1638	FLEXCURVE TRIP TIME AT 6.00 × PU	0 to 65535	1	ms	F1	65535
1639	FLEXCURVE TRIP TIME AT 6.50 × PU	0 to 65535	1	ms	F1	65535
163A	FLEXCURVE TRIP TIME AT 7.00 × PU	0 to 65535	1	ms	F1	65535
163B	FLEXCURVE TRIP TIME AT 7.50 × PU	0 to 65535	1	ms	F1	65535
163C	FLEXCURVE TRIP TIME AT 8.00 × PU	0 to 65535	1	ms	F1	65535
163D	FLEXCURVE TRIP TIME AT 8.50 × PU	0 to 65535	1	ms	F1	65535
163E	FLEXCURVE TRIP TIME AT 9.00 × PU	0 to 65535	1	ms	F1	65535
163F	FLEXCURVE TRIP TIME AT 9.50 × PU	0 to 65535	1	ms	F1	65535
1640	FLEXCURVE TRIP TIME AT 10.0 × PU	0 to 65535	1	ms	F1	65535
1641	FLEXCURVE TRIP TIME AT 10.5 × PU	0 to 65535	1	ms	F1	65535
1642	FLEXCURVE TRIP TIME AT 11.0 × PU	0 to 65535	1	ms	F1	65535

1, 2, 3 See Table footnotes on page 6–39

Table 6–1: 489 MEMORY MAP (Sheet 14 of 29)

ADDR	NAME	RANGE	STEP	UNITS	FORMAT	DEFAULT
1643	FLEXCURVE TRIP TIME AT 11.5 × PU	0 to 65535	1	ms	F1	65535
1644	FLEXCURVE TRIP TIME AT 12.0 × PU	0 to 65535	1	ms	F1	65535
1645	FLEXCURVE TRIP TIME AT 12.5 × PU	0 to 65535	1	ms	F1	65535
1646	FLEXCURVE TRIP TIME AT 13.0 × PU	0 to 65535	1	ms	F1	65535
1647	FLEXCURVE TRIP TIME AT 13.5 × PU	0 to 65535	1	ms	F1	65535
1648	FLEXCURVE TRIP TIME AT 14.0 × PU	0 to 65535	1	ms	F1	65535
1649	FLEXCURVE TRIP TIME AT 14.5 × PU	0 to 65535	1	ms	F1	65535
164A	FLEXCURVE TRIP TIME AT 15.0 × PU	0 to 65535	1	ms	F1	65535
164B	FLEXCURVE TRIP TIME AT 15.5 × PU	0 to 65535	1	ms	F1	65535
164C	FLEXCURVE TRIP TIME AT 16.0 × PU	0 to 65535	1	ms	F1	65535
164D	FLEXCURVE TRIP TIME AT 16.5 × PU	0 to 65535	1	ms	F1	65535
164E	FLEXCURVE TRIP TIME AT 17.0 × PU	0 to 65535	1	ms	F1	65535
164F	FLEXCURVE TRIP TIME AT 17.5 × PU	0 to 65535	1	ms	F1	65535
1650	FLEXCURVE TRIP TIME AT 18.0 × PU	0 to 65535	1	ms	F1	65535
1651	FLEXCURVE TRIP TIME AT 18.5 × PU	0 to 65535	1	ms	F1	65535
1652	FLEXCURVE TRIP TIME AT 19.0 × PU	0 to 65535	1	ms	F1	65535
1653	FLEXCURVE TRIP TIME AT 19.5 × PU	0 to 65535	1	ms	F1	65535
1654	FLEXCURVE TRIP TIME AT 20.0 × PU	0 to 65535	1	ms	F1	65535
1655	OVERCURRENT CURVE MULTIPLIER	0 to 100000	1	–	F14	100
1657	OVERCURRENT CURVE RESET	0 to 1	1	–	F201	0
1658	VOLTAGE LOWER LIMIT	10 to 60	1	%	F1	10
CURRENT ELEMENTS / NEGATIVE SEQUENCE						
1700	NEGATIVE SEQUENCE ALARM	0 to 2	1	–	F115	0
1701	ASSIGN ALARM RELAYS (2-5)	1 to 4	1	–	F50	16
1702	NEG. SEQUENCE ALARM PICKUP	3 to 100	1	%FLA	F1	3
1703	NEGATIVE SEQUENCE ALARM DELAY	1 to 1000	1	s	F2	50
1704	NEGATIVE SEQUENCE ALARM EVENTS	0 to 1	1	–	F105	0
1705	NEGATIVE SEQUENCE O/C TRIP	0 to 2	1	–	F115	0
1706	ASSIGN TRIP RELAYS (1-4)	0 to 3	1	–	F50	1
1707	NEG. SEQUENCE O/C TRIP PICKUP	3 to 100	1	%FLA	F1	8
1708	NEG. SEQUENCE O/C CONSTANT K	1 to 100	1	–	F1	1
1709	NEG. SEQUENCE O/C MAX. TIME	10 to 1000	1	s	F1	1000
170A	NEG. SEQUENCE O/C RESET RATE	0 to 9999	1	s	F2	2270
CURRENT ELEMENTS / GROUND O/C						
1720	GROUND OVERCURRENT ALARM	0 to 2	1	–	F115	0
1721	ASSIGN ALARM RELAYS (2-5)	1 to 4	1	–	F50	16
1722	GROUND O/C ALARM PICKUP	5 to 2000	1	× CT	F3	20
1723	GROUND O/C ALARM DELAY	0 to 100	1	Cycles	F1	0
1724	GROUND OVERCURRENT ALARM EVENTS	0 to 1	1	–	F105	0
1725	GROUND OVERCURRENT TRIP	0 to 2	1	–	F115	0
1726	ASSIGN TRIP RELAYS (1-4)	0 to 3	1	–	F50	1
1727	GROUND O/C TRIP PICKUP	5 to 2000	1	× CT	F3	20
1728	CURVE SHAPE	0 to 13	1	–	F128	0
1729	FLEXCURVE TRIP TIME AT 1.03 × PU	0 to 65535	1	ms	F1	65535
172A	FLEXCURVE TRIP TIME AT 1.05 × PU	0 to 65535	1	ms	F1	65535
172B	FLEXCURVE TRIP TIME AT 1.10 × PU	0 to 65535	1	ms	F1	65535
172C	FLEXCURVE TRIP TIME AT 1.20 × PU	0 to 65535	1	ms	F1	65535
172D	FLEXCURVE TRIP TIME AT 1.30 × PU	0 to 65535	1	ms	F1	65535
172E	FLEXCURVE TRIP TIME AT 1.40 × PU	0 to 65535	1	ms	F1	65535
172F	FLEXCURVE TRIP TIME AT 1.50 × PU	0 to 65535	1	ms	F1	65535
1730	FLEXCURVE TRIP TIME AT 1.60 × PU	0 to 65535	1	ms	F1	65535
1731	FLEXCURVE TRIP TIME AT 1.70 × PU	0 to 65535	1	ms	F1	65535
1732	FLEXCURVE TRIP TIME AT 1.80 × PU	0 to 65535	1	ms	F1	65535

1, 2, 3 See Table footnotes on page 6–39

Table 6–1: 489 MEMORY MAP (Sheet 15 of 29)

ADDR	NAME	RANGE	STEP	UNITS	FORMAT	DEFAULT
1733	FLEXCURVE TRIP TIME AT 1.90 × PU	0 to 65535	1	ms	F1	65535
1734	FLEXCURVE TRIP TIME AT 2.00 × PU	0 to 65535	1	ms	F1	65535
1735	FLEXCURVE TRIP TIME AT 2.10 × PU	0 to 65535	1	ms	F1	65535
1736	FLEXCURVE TRIP TIME AT 2.20 × PU	0 to 65535	1	ms	F1	65535
1737	FLEXCURVE TRIP TIME AT 2.30 × PU	0 to 65535	1	ms	F1	65535
1738	FLEXCURVE TRIP TIME AT 2.40 × PU	0 to 65535	1	ms	F1	65535
1739	FLEXCURVE TRIP TIME AT 2.50 × PU	0 to 65535	1	ms	F1	65535
173A	FLEXCURVE TRIP TIME AT 2.60 × PU	0 to 65535	1	ms	F1	65535
173B	FLEXCURVE TRIP TIME AT 2.70 × PU	0 to 65535	1	ms	F1	65535
173C	FLEXCURVE TRIP TIME AT 2.80 × PU	0 to 65535	1	ms	F1	65535
173D	FLEXCURVE TRIP TIME AT 2.90 × PU	0 to 65535	1	ms	F1	65535
173E	FLEXCURVE TRIP TIME AT 3.00 × PU	0 to 65535	1	ms	F1	65535
173F	FLEXCURVE TRIP TIME AT 3.10 × PU	0 to 65535	1	ms	F1	65535
1740	FLEXCURVE TRIP TIME AT 3.20 × PU	0 to 65535	1	ms	F1	65535
1741	FLEXCURVE TRIP TIME AT 3.30 × PU	0 to 65535	1	ms	F1	65535
1742	FLEXCURVE TRIP TIME AT 3.40 × PU	0 to 65535	1	ms	F1	65535
1743	FLEXCURVE TRIP TIME AT 3.50 × PU	0 to 65535	1	ms	F1	65535
1744	FLEXCURVE TRIP TIME AT 3.60 × PU	0 to 65535	1	ms	F1	65535
1745	FLEXCURVE TRIP TIME AT 3.70 × PU	0 to 65535	1	ms	F1	65535
1746	FLEXCURVE TRIP TIME AT 3.80 × PU	0 to 65535	1	ms	F1	65535
1747	FLEXCURVE TRIP TIME AT 3.90 × PU	0 to 65535	1	ms	F1	65535
1748	FLEXCURVE TRIP TIME AT 4.00 × PU	0 to 65535	1	ms	F1	65535
1749	FLEXCURVE TRIP TIME AT 4.10 × PU	0 to 65535	1	ms	F1	65535
174A	FLEXCURVE TRIP TIME AT 4.20 × PU	0 to 65535	1	ms	F1	65535
174B	FLEXCURVE TRIP TIME AT 4.30 × PU	0 to 65535	1	ms	F1	65535
174C	FLEXCURVE TRIP TIME AT 4.40 × PU	0 to 65535	1	ms	F1	65535
174D	FLEXCURVE TRIP TIME AT 4.50 × PU	0 to 65535	1	ms	F1	65535
174E	FLEXCURVE TRIP TIME AT 4.60 × PU	0 to 65535	1	ms	F1	65535
174F	FLEXCURVE TRIP TIME AT 4.70 × PU	0 to 65535	1	ms	F1	65535
1750	FLEXCURVE TRIP TIME AT 4.80 × PU	0 to 65535	1	ms	F1	65535
1751	FLEXCURVE TRIP TIME AT 4.90 × PU	0 to 65535	1	ms	F1	65535
1752	FLEXCURVE TRIP TIME AT 5.00 × PU	0 to 65535	1	ms	F1	65535
1753	FLEXCURVE TRIP TIME AT 5.10 × PU	0 to 65535	1	ms	F1	65535
1754	FLEXCURVE TRIP TIME AT 5.20 × PU	0 to 65535	1	ms	F1	65535
1755	FLEXCURVE TRIP TIME AT 5.30 × PU	0 to 65535	1	ms	F1	65535
1756	FLEXCURVE TRIP TIME AT 5.40 × PU	0 to 65535	1	ms	F1	65535
1757	FLEXCURVE TRIP TIME AT 5.50 × PU	0 to 65535	1	ms	F1	65535
1758	FLEXCURVE TRIP TIME AT 5.60 × PU	0 to 65535	1	ms	F1	65535
1759	FLEXCURVE TRIP TIME AT 5.70 × PU	0 to 65535	1	ms	F1	65535
175A	FLEXCURVE TRIP TIME AT 5.80 × PU	0 to 65535	1	ms	F1	65535
175B	FLEXCURVE TRIP TIME AT 5.90 × PU	0 to 65535	1	ms	F1	65535
175C	FLEXCURVE TRIP TIME AT 6.00 × PU	0 to 65535	1	ms	F1	65535
175D	FLEXCURVE TRIP TIME AT 6.50 × PU	0 to 65535	1	ms	F1	65535
175E	FLEXCURVE TRIP TIME AT 7.00 × PU	0 to 65535	1	ms	F1	65535
175F	FLEXCURVE TRIP TIME AT 7.50 × PU	0 to 65535	1	ms	F1	65535
1760	FLEXCURVE TRIP TIME AT 8.00 × PU	0 to 65535	1	ms	F1	65535
1761	FLEXCURVE TRIP TIME AT 8.50 × PU	0 to 65535	1	ms	F1	65535
1762	FLEXCURVE TRIP TIME AT 9.00 × PU	0 to 65535	1	ms	F1	65535
1763	FLEXCURVE TRIP TIME AT 9.50 × PU	0 to 65535	1	ms	F1	65535
1764	FLEXCURVE TRIP TIME AT 10.0 × PU	0 to 65535	1	ms	F1	65535
1765	FLEXCURVE TRIP TIME AT 10.5 × PU	0 to 65535	1	ms	F1	65535
1766	FLEXCURVE TRIP TIME AT 11.0 × PU	0 to 65535	1	ms	F1	65535
1767	FLEXCURVE TRIP TIME AT 11.5 × PU	0 to 65535	1	ms	F1	65535

1, 2, 3 See Table footnotes on page 6–39

Table 6–1: 489 MEMORY MAP (Sheet 16 of 29)

ADDR	NAME	RANGE	STEP	UNITS	FORMAT	DEFAULT
1768	FLEXCURVE TRIP TIME AT 12.0 × PU	0 to 65535	1	ms	F1	65535
1769	FLEXCURVE TRIP TIME AT 12.5 × PU	0 to 65535	1	ms	F1	65535
176A	FLEXCURVE TRIP TIME AT 13.0 × PU	0 to 65535	1	ms	F1	65535
176B	FLEXCURVE TRIP TIME AT 13.5 × PU	0 to 65535	1	ms	F1	65535
176C	FLEXCURVE TRIP TIME AT 14.0 × PU	0 to 65535	1	ms	F1	65535
176D	FLEXCURVE TRIP TIME AT 14.5 × PU	0 to 65535	1	ms	F1	65535
176E	FLEXCURVE TRIP TIME AT 15.0 × PU	0 to 65535	1	ms	F1	65535
176F	FLEXCURVE TRIP TIME AT 15.5 × PU	0 to 65535	1	ms	F1	65535
1770	FLEXCURVE TRIP TIME AT 16.0 × PU	0 to 65535	1	ms	F1	65535
1771	FLEXCURVE TRIP TIME AT 16.5 × PU	0 to 65535	1	ms	F1	65535
1772	FLEXCURVE TRIP TIME AT 17.0 × PU	0 to 65535	1	ms	F1	65535
1773	FLEXCURVE TRIP TIME AT 17.5 × PU	0 to 65535	1	ms	F1	65535
1774	FLEXCURVE TRIP TIME AT 18.0 × PU	0 to 65535	1	ms	F1	65535
1775	FLEXCURVE TRIP TIME AT 18.5 × PU	0 to 65535	1	ms	F1	65535
1776	FLEXCURVE TRIP TIME AT 19.0 × PU	0 to 65535	1	ms	F1	65535
1777	FLEXCURVE TRIP TIME AT 19.5 × PU	0 to 65535	1	ms	F1	65535
1778	FLEXCURVE TRIP TIME AT 20.0 × PU	0 to 65535	1	ms	F1	65535
1779	OVERCURRENT CURVE MULTIPLIER	0 to 100000	1	–	F14	100
177B	OVERCURRENT CURVE RESET	0 to 1	1	–	F201	0
CURRENT ELEMENTS / PHASE DIFFERENTIAL						
17E0	PHASE DIFFERENTIAL TRIP	0 to 2	1	–	F115	0
17E1	ASSIGN TRIP RELAYS (1-4)	0 to 3	1	–	F50	1
17E2	DIFFERENTIAL TRIP MIN. PICKUP	5 to 100	1	× CT	F3	10
17E3	DIFFERENTIAL TRIP SLOPE 1	1 to 100	1	%	F1	10
17E4	DIFFERENTIAL TRIP SLOPE 2	1 to 100	1	%	F1	20
17E5	DIFFERENTIAL TRIP DELAY	0 to 100	1	cycles	F1	0
CURRENT ELEMENTS / GROUND DIRECTIONAL						
1800	SUPERVISE WITH DIGITAL INPUT	0 to 1	1	–	F103	1
1801	GROUND DIRECTIONAL MTA	0 to 3	1	–	F217	0
1802	GROUND DIRECTIONAL ALARM	0 to 2	1	–	F115	0
1803	ASSIGN ALARM RELAYS (2-5)	1 to 4	1	–	F50	16
1804	GROUND DIR. ALARM PICKUP	5 to 2000	1	× CT	F3	5
1805	GROUND DIR. ALARM DELAY	1 to 1200	1	s	F2	30
1806	GROUND DIR. ALARM EVENTS	0 to 1	1	–	F105	0
1807	GROUND DIRECTIONAL TRIP	0 to 2	1	–	F115	0
1808	ASSIGN TRIP RELAYS (1-4)	0 to 3	1	–	F50	1
1809	GROUND DIR. TRIP PICKUP	5 to 2000	1	× CT	F3	5
180A	GROUND DIR. TRIP DELAY	1 to 1200	1	s	F2	30
CURRENT ELEMENTS / HIGH-SET PHASE O/C						
1830	HIGH-SET PHASE O/C TRIP	0 to 2	1	–	F115	0
1831	ASSIGN TRIP RELAYS (1-4)	0 to 3	1	–	F50	1
1832	HIGH-SET PHASE O/C PICKUP	15 to 2000	1	× CT	F3	500
1833	HIGH-SET PHASE O/C DELAY	0 to 10000	1	s	F3	100
VOLTAGE ELEMENTS / UNDERVOLTAGE						
2000	UNDERVOLTAGE ALARM	0 to 2	1	–	F115	0
2001	ASSIGN ALARM RELAYS (2-5)	1 to 4	1	–	F50	16
2002	UNDERVOLTAGE ALARM PICKUP	50 to 99	1	× Rated	F3	85
2003	UNDERVOLTAGE ALARM DELAY	2 to 1200	1	s	F2	30
2004	UNDERVOLTAGE ALARM EVENTS	0 to 1	1	–	F105	0
2005	UNDERVOLTAGE TRIP	0 to 2	1	–	F115	0
2006	ASSIGN TRIP RELAYS (1-4)	0 to 3	1	–	F50	1
2007	UNDERVOLTAGE TRIP PICKUP	50 to 99	1	× Rated	F3	80
2008	UNDERVOLTAGE TRIP DELAY	2 to 100	1	s	F2	10

1, 2, 3 See Table footnotes on page 6–39

Table 6–1: 489 MEMORY MAP (Sheet 17 of 29)

ADDR	NAME	RANGE	STEP	UNITS	FORMAT	DEFAULT
2009	UNDERVOLTAGE CURVE RESET RATE	0 to 9999	1	s	F2	14
200A	UNDERVOLTAGE CURVE ELEMENT	0 to 1	1	–	F208	0
VOLTAGE ELEMENTS / OVERVOLTAGE						
2020	OVERVOLTAGE ALARM	0 to 2	1	–	F115	0
2021	ASSIGN ALARM RELAYS (2-5)	1 to 4	1	–	F50	16
2022	OVERVOLTAGE ALARM PICKUP	101 to 150	1	× Rated	F3	115
2023	OVERVOLTAGE ALARM DELAY	1 to 1200	1	s	F2	30
2024	OVERVOLTAGE ALARM EVENTS	0 to 1	1	–	F105	0
2025	OVERVOLTAGE TRIP	0 to 2	1	–	F115	0
2026	ASSIGN TRIP RELAYS (1-4)	0 to 3	1	–	F50	1
2027	OVERVOLTAGE TRIP PICKUP	101 to 150	1	× Rated	F3	120
2028	OVERVOLTAGE TRIP DELAY	1 to 100	1	s	F2	10
2029	OVERVOLTAGE CURVE RESET RATE	0 to 9999	1	s	F2	14
202A	OVERVOLTAGE CURVE ELEMENT	0 to 1	1	–	F208	0
VOLTAGE ELEMENTS / VOLTS/HERTZ						
2040	VOLTS/HERTZ ALARM	0 to 2	1	–	F115	0
2041	ASSIGN ALARM RELAYS (2-5)	1 to 4	1	–	F50	16
2042	VOLTS/HERTZ ALARM PICKUP	50 to 199	1	× Nominal	F3	100
2043	VOLTS/HERTZ ALARM DELAY	1 to 1500	1	s	F2	30
2044	VOLTS/HERTZ ALARM EVENTS	0 to 1	1	–	F105	0
2045	VOLTS/HERTZ TRIP	0 to 2	1	–	F115	0
2046	ASSIGN TRIP RELAYS (1-4)	0 to 3	1	–	F50	1
2047	VOLTS/HERTZ TRIP PICKUP	50 to 199	1	× Nominal	F3	100
2048	VOLTS/HERTZ TRIP DELAY	1 to 1500	1	s	F2	10
2049	VOLTS/HERTZ CURVE RESET RATE	0 to 9999	1	s	F2	14
204A	VOLTS/HERTZ TRIP ELEMENT	0 to 3	1	–	F211	0
VOLTAGE ELEMENTS / PHASE REVERSAL						
2060	PHASE REVERSAL TRIP	0 to 2	1	–	F115	0
2061	ASSIGN TRIP RELAYS (1-4)	0 to 3	1	–	F50	1
VOLTAGE ELEMENTS / UNDERFREQUENCY						
2080	BLOCK UNDERFREQUENCY FROM ONLINE	0 to 5	1	s	F1	1
2081	VOLTAGE LEVEL CUTOFF	50 to 99	1	× Rated	F3	50
2082	UNDERFREQUENCY ALARM	0 to 2	1	–	F115	0
2083	ASSIGN ALARM RELAYS (2-5)	1 to 4	1	–	F50	16
2084	UNDERFREQUENCY ALARM LEVEL	2000 to 6000	1	Hz	F3	5950
2085	UNDERFREQUENCY ALARM DELAY	1 to 50000	1	s	F2	50
2086	UNDERFREQUENCY ALARM EVENTS	0 to 1	1	–	F105	0
2087	UNDERFREQUENCY TRIP	0 to 2	1	–	F115	0
2088	ASSIGN TRIP RELAYS (1-4)	0 to 3	1	–	F50	1
2089	UNDERFREQUENCY TRIP LEVEL1	2000 to 6000	1	Hz	F3	5950
208A	UNDERFREQUENCY TRIP DELAY1	1 to 50000	1	s	F2	600
208B	UNDERFREQUENCY TRIP LEVEL2	2000 to 6000	1	Hz	F3	5800
208C	UNDERFREQUENCY TRIP DELAY2	1 to 50000	1	s	F2	300
VOLTAGE ELEMENTS / OVERFREQUENCY						
20A0	BLOCK OVERFREQUENCY FROM ONLINE	0 to 5	1	s	F1	1
20A1	VOLTAGE LEVEL CUTOFF	50 to 99	1	× Rated	F3	50
20A2	OVERFREQUENCY ALARM	0 to 2	1	–	F115	0
20A3	ASSIGN ALARM RELAYS (2-5)	1 to 4	1	–	F50	16
20A4	OVERFREQUENCY ALARM LEVEL	2501 to 7000	1	Hz	F3	6050
20A5	OVERFREQUENCY ALARM DELAY	1 to 50000	1	s	F2	50
20A6	OVERFREQUENCY ALARM EVENTS	0 to 1	1	–	F105	0
20A7	OVERFREQUENCY TRIP	0 to 2	1	–	F115	0
20A8	ASSIGN TRIP RELAYS (1-4)	0 to 3	1	–	F50	1

1, 2, 3 See Table footnotes on page 6–39

Table 6–1: 489 MEMORY MAP (Sheet 18 of 29)

ADDR	NAME	RANGE	STEP	UNITS	FORMAT	DEFAULT
20A9	OVERFREQUENCY TRIP LEVEL1	2501 to 7000	1	Hz	F3	6050
20AA	OVERFREQUENCY TRIP DELAY1	1 to 50000	1	s	F2	600
20AB	OVERFREQUENCY TRIP LEVEL2	2501 to 7000	1	Hz	F3	6200
20AC	OVERFREQUENCY TRIP DELAY2	1 to 50000	1	s	F2	300
VOLTAGE ELEMENTS / NEUTRAL O/V (FUND)						
20C0	NEUTRAL OVERVOLTAGE ALARM	0 to 2	1	–	F115	0
20C1	ASSIGN ALARM RELAYS (2-5)	1 to 4	1	–	F50	16
20C2	NEUTRAL O/V ALARM LEVEL	20 to 1000	1	V	F2	30
20C3	NEUTRAL OVERVOLTAGE ALARM DELAY	1 to 1200	1	s	F2	10
20C4	NEUTRAL OVERVOLTAGE ALARM EVENTS	0 to 1	1	–	F105	0
20C5	NEUTRAL OVERVOLTAGE TRIP	0 to 2	1	–	F115	0
20C6	ASSIGN TRIP RELAYS (1-4)	0 to 3	1	–	F50	1
20C7	NEUTRAL O/V TRIP LEVEL	20 to 1000	1	V	F2	50
20C8	NEUTRAL OVERVOLTAGE TRIP DELAY	1 to 1200	1	s	F2	10
20C9	SUPERVISE WITH DIGITAL INPUT	0 to 1	1	–	F103	0
20CA	NEUTRAL O/V CURVE RESET RATE	0 to 9999	1	s	F2	0
20CB	NEUTRAL O/V TRIP ELEMENT	0 to 1	1	–	F208	1
VOLTAGE ELEMENTS / NEUTRAL U/V (3rd)						
20E0	LOW POWER BLOCKING LEVEL	2 to 99	1	× Rated MW	F14	5
20E2	LOW VOLTAGE BLOCKING LEVEL	50 to 100	1	× Rated	F3	75
20E3	NEUTRAL UNDERVOLTAGE ALARM	0 to 2	1	–	F115	0
20E4	ASSIGN ALARM RELAYS (2-5)	1 to 4	1	–	F50	16
20E5	NEUTRAL U/V ALARM LEVEL	5 to 200	1	V	F2	5
20E6	NEUTRAL UNDERVOLTAGE ALARM DELAY	5 to 120	1	s	F1	30
20E7	NEUTRAL UNDERVOLTAGE ALARM EVENTS	0 to 1	1	–	F105	0
20E8	NEUTRAL UNDERVOLTAGE TRIP	0 to 2	1	–	F115	0
20E9	ASSIGN TRIP RELAYS (1-4)	0 to 3	1	–	F50	1
20EA	NEUTRAL U/V TRIP LEVEL	5 to 200	1	V	F2	10
20EB	NEUTRAL UNDERVOLTAGE TRIP DELAY	5 to 120	1	s	F1	30
VOLTAGE ELEMENTS / LOSS OF EXCITATION						
2100	ENABLE VOLTAGE SUPERVISION	0 to 1	1	–	F103	0
2101	VOLTAGE LEVEL	70 to 100	1	× rated	F3	70
2102	CIRCLE 1 TRIP	0 to 2	1	–	F115	0
2103	ASSIGN CIRCLE 1 TRIP RELAYS (1-4)	0 to 3	1	–	F50	1
2104	CIRCLE 1 DIAMETER	25 to 3000	1	Ω s	F2	250
2105	CIRCLE 1 OFFSET	10 to 3000	1	Ω s	F2	25
2106	CIRCLE 1 TRIP DELAY	1 to 100	1	s	F2	50
2107	CIRCLE 2 TRIP	0 to 2	1	–	F115	0
2108	ASSIGN CIRCLE 2 TRIP RELAYS (1-4)	0 to 3	1	–	F50	1
2109	CIRCLE 2 DIAMETER	25 to 3000	1	Ω s	F2	350
210A	CIRCLE 2 OFFSET	10 to 3000	1	Ω s	F2	25
210B	CIRCLE 2 TRIP DELAY	1 to 100	1	s	F2	50
VOLTAGE ELEMENTS / DISTANCE ELEMENT						
2130	STEP UP TRANSFORMER SETUP	0 to 1	1	–	F219	0
2131	FUSE FAILURE SUPERVISION	0 to 1	1	–	F105	0
2132	ZONE 1 TRIP	0 to 2	1	–	F115	0
2133	ASSIGN ZONE 1 TRIP RELAYS (1-4)	0 to 3	1	–	F50	1
2134	ZONE 1 REACH	1 to 5000	1	Ω s	F2	100
2135	ZONE 1 ANGLE	50 to 85	1	°	F1	75
2136	ZONE 1 TRIP DELAY	0 to 1500	1	s	F2	4
2137	ZONE 2 TRIP	0 to 2	1	–	F115	0
2138	ASSIGN ZONE 2 TRIP RELAYS (1-4)	0 to 3	1	–	F50	1
2139	ZONE 2 REACH	1 to 5000	1	Ω s	F2	100

1, 2, 3 See Table footnotes on page 6–39

Table 6–1: 489 MEMORY MAP (Sheet 19 of 29)

ADDR	NAME	RANGE	STEP	UNITS	FORMAT	DEFAULT
213A	ZONE 2 ANGLE	50 to 85	1	°	F1	75
213B	ZONE 2 TRIP DELAY	0 to 1500	1	s	F2	20
POWER ELEMENTS / REACTIVE POWER						
2200	BLOCK Mvar ELEMENT FROM ONLINE	0 to 5000	1	s	F1	1
2201	REACTIVE POWER ALARM	0 to 2	1	–	F115	0
2202	ASSIGN ALARM RELAYS (2-5)	1 to 4	1	–	F50	16
2203	POSITIVE Mvar ALARM LEVEL ³	2 to 201	1	x rated	F14	85
2205	NEGATIVE Mvar ALARM LEVEL ³	2 to 201	1	x rated	F14	85
2207	NEGATIVE Mvar ALARM DELAY	2 to 1200	1	s	F2	10
2208	REACTIVE POWER ALARM EVENTS	0 to 1	1	–	F105	0
2209	REACTIVE POWER TRIP	0 to 2	1	–	F115	0
220A	ASSIGN TRIP RELAYS (1-4)	0 to 3	1	–	F50	1
220B	POSITIVE Mvar TRIP LEVEL ³	2 to 201	1	Mvar	F14	80
220D	NEGATIVE Mvar TRIP LEVEL ³	2 to 201	1	Mvar	F14	80
220F	NEGATIVE Mvar TRIP DELAY	2 to 1200	1	s	F2	10
2210	POSITIVE Mvar TRIP DELAY	2 to 1200	1	s	F2	200
2211	POSITIVE Mvar ALARM DELAY	2 to 1200	1	s	F2	100
POWER ELEMENTS / REVERSE POWER						
2240	BLOCK REVERSE POWER FROM ONLINE	0 to 5000	1	s	F1	1
2241	REVERSE POWER ALARM	0 to 2	1	–	F115	0
2242	ASSIGN ALARM RELAYS (2-5)	1 to 4	1	–	F50	16
2243	REVERSE POWER ALARM LEVEL	2 to 99	1	x Rated	F14	5
2245	REVERSE POWER ALARM DELAY	2 to 1200	1	s	F2	100
2246	REVERSE POWER ALARM EVENTS	0 to 1	1	–	F105	0
2247	REVERSE POWER TRIP	0 to 2	1	–	F115	0
2248	ASSIGN TRIP RELAYS (1-4)	0 to 3	1	–	F50	1
2249	REVERSE POWER TRIP LEVEL	2 to 99	1	x Rated	F14	5
224B	REVERSE POWER TRIP DELAY	2 to 1200	1	s	F2	200
POWER ELEMENTS / LOW FORWARD POWER						
2280	BLOCK LOW FWD POWER FROM ONLINE	0 to 15000	1	s	F1	0
2281	LOW FORWARD POWER ALARM	0 to 2	1	–	F115	0
2282	ASSIGN ALARM RELAYS (2-5)	1 to 4	1	–	F50	16
2283	LOW FWD POWER ALARM LEVEL	2 to 99	1	x Rated MW	F14	5
2285	LOW FWD POWER ALARM DELAY	2 to 1200	1	s	F2	100
2286	LOW FWD POWER ALARM EVENTS	0 to 1	1	–	F105	0
2287	LOW FORWARD POWER TRIP	0 to 2	1	–	F115	0
2288	ASSIGN TRIP RELAYS (1-4)	0 to 3	1	–	F50	1
2289	LOW FWD POWER TRIP LEVEL	2 to 99	1	x Rated MW	F14	5
228B	LOW FWD POWER TRIP DELAY	2 to 1200	1	s	F2	200
RTD TEMPERATURE / RTD TYPES						
2400	STATOR RTD TYPE	0 to 3	1	–	F120	0
2401	BEARING RTD TYPE	0 to 3	1	–	F120	0
2402	AMBIENT RTD TYPE	0 to 3	1	–	F120	0
2403	OTHER RTD TYPE	0 to 3	1	–	F120	0
RTD TEMPERATURE / RTD #1						
2420	RTD #1 APPLICATION	0 to 4	1	–	F121	1
2421	RTD #1 ALARM	0 to 2	1	–	F115	0
2422	ASSIGN ALARM RELAYS (2-5)	1 to 4	1	–	F50	16
2423	RTD #1 ALARM TEMPERATURE	1 to 250	1	°C	F1	130
2424	RTD #1 ALARM EVENTS	0 to 1	1	–	F105	0
2425	RTD #1 TRIP	0 to 2	1	–	F115	0
2426	RTD #1 TRIP VOTING	1 to 12	1	–	F122	1

1, 2, 3 See Table footnotes on page 6–39

Table 6–1: 489 MEMORY MAP (Sheet 20 of 29)

ADDR	NAME	RANGE	STEP	UNITS	FORMAT	DEFAULT
2427	ASSIGN TRIP RELAYS (1-4)	0 to 3	1	–	F50	1
2428	RTD #1 TRIP TEMPERATURE	1 to 250	1	°C	F1	155
2429	RTD #1 NAME	0 to 8	1	–	F22	–
RTD TEMPERATURE / RTD #2						
2460	RTD #2 APPLICATION	0 to 4	1	–	F121	1
2461	RTD #2 ALARM	0 to 2	1	–	F115	0
2462	ASSIGN ALARM RELAYS (2-5)	1 to 4	1	–	F50	16
2463	RTD #2 ALARM TEMPERATURE	1 to 250	1	°C	F1	130
2464	RTD #2 ALARM EVENTS	0 to 1	1	–	F105	0
2465	RTD #2 TRIP	0 to 2	1	–	F115	0
2466	RTD #2 TRIP VOTING	1 to 12	1	–	F122	2
2467	ASSIGN TRIP RELAYS (1-4)	0 to 3	1	–	F50	1
2468	RTD #2 TRIP TEMPERATURE	1 to 250	1	°C	F1	155
2469	RTD #2 NAME	0 to 8	1	–	F22	–
RTD TEMPERATURE / RTD #3						
24A0	RTD #3 APPLICATION	0 to 4	1	–	F121	1
24A1	RTD #3 ALARM	0 to 2	1	–	F115	0
24A2	ASSIGN ALARM RELAYS (2-5)	1 to 4	1	–	F50	16
24A3	RTD #3 ALARM TEMPERATURE	1 to 250	1	°C	F1	130
24A4	RTD #3 ALARM EVENTS	0 to 1	1	–	F105	0
24A5	RTD #3 TRIP	0 to 2	1	–	F115	0
24A6	RTD #3 TRIP VOTING	1 to 12	1	–	F122	3
24A7	ASSIGN TRIP RELAYS (1-4)	0 to 3	1	–	F50	1
24A8	RTD #3 TRIP TEMPERATURE	1 to 250	1	°C	F1	155
24A9	RTD #3 NAME	0 to 8	1	–	F22	–
RTD TEMPERATURE / RTD #4						
24E0	RTD #4 APPLICATION	0 to 4	1	–	F121	1
24E1	RTD #4 ALARM	0 to 2	1	–	F115	0
24E2	ASSIGN ALARM RELAYS (2-5)	1 to 4	1	–	F50	16
24E3	RTD #4 ALARM TEMPERATURE	1 to 250	1	°C	F1	130
24E4	RTD #4 ALARM EVENTS	0 to 1	1	–	F105	0
24E5	RTD #4 TRIP	0 to 2	1	–	F115	0
24E6	RTD #4 TRIP VOTING	1 to 12	1	–	F122	4
24E7	ASSIGN TRIP RELAYS (1-4)	0 to 3	1	–	F50	1
24E8	RTD #4 TRIP TEMPERATURE	1 to 250	1	°C	F1	155
24E9	RTD #4 NAME	0 to 8	1	–	F22	–
RTD TEMPERATURE / RTD #5						
2520	RTD #5 APPLICATION	0 to 4	1	–	F121	1
2521	RTD #5 ALARM	0 to 2	1	–	F115	0
2522	ASSIGN ALARM RELAYS (2-5)	1 to 4	1	–	F50	16
2523	RTD #5 ALARM TEMPERATURE	1 to 250	1	°C	F1	130
2524	RTD #5 ALARM EVENTS	0 to 1	1	–	F105	0
2525	RTD #5 TRIP	0 to 2	1	–	F115	0
2526	RTD #5 TRIP VOTING	1 to 12	1	–	F122	5
2527	ASSIGN TRIP RELAYS (1-4)	0 to 3	1	–	F50	1
2528	RTD #5 TRIP TEMPERATURE	1 to 250	1	°C	F1	155
2529	RTD #5 NAME	0 to 8	1	–	F22	–
RTD TEMPERATURE / RTD #6						
2560	RTD #6 APPLICATION	0 to 4	1	–	F121	1
2561	RTD #6 ALARM	0 to 2	1	–	F115	0
2562	ASSIGN ALARM RELAYS (2-5)	1 to 4	1	–	F50	16
2563	RTD #6 ALARM TEMPERATURE	1 to 250	1	°C	F1	130
2564	RTD #6 ALARM EVENTS	0 to 1	1	–	F105	0

1, 2, 3 See Table footnotes on page 6–39

Table 6–1: 489 MEMORY MAP (Sheet 21 of 29)

ADDR	NAME	RANGE	STEP	UNITS	FORMAT	DEFAULT
2565	RTD #6 TRIP	0 to 2	1	–	F115	0
2566	RTD #6 TRIP VOTING	1 to 12	1	–	F122	6
2567	ASSIGN TRIP RELAYS (1-4)	0 to 3	1	–	F50	1
2568	RTD #6 TRIP TEMPERATURE	1 to 250	1	°C	F1	155
2569	RTD #6 NAME	0 to 8	1	–	F22	–
RTD TEMPERATURE / RTD #7						
25A0	RTD #7 APPLICATION	0 to 4	1	–	F121	2
25A1	RTD #7 ALARM	0 to 2	1	–	F115	0
25A2	ASSIGN ALARM RELAYS (2-5)	1 to 4	1	–	F50	16
25A3	RTD #7 ALARM TEMPERATURE	1 to 250	1	°C	F1	80
25A4	RTD #7 ALARM EVENTS	0 to 1	1	–	F105	0
25A5	RTD #7 TRIP	0 to 2	1	–	F115	0
25A6	RTD #7 TRIP VOTING	1 to 12	1	–	F122	7
25A7	ASSIGN TRIP RELAYS (1-4)	0 to 3	1	–	F50	1
25A8	RTD #7 TRIP TEMPERATURE	1 to 250	1	°C	F1	90
25A9	RTD #7 NAME	0 to 8	1	–	F22	–
RTD TEMPERATURE / RTD #8						
25E0	RTD #8 APPLICATION	0 to 4	1	–	F121	2
25E1	RTD #8 ALARM	0 to 2	1	–	F115	0
25E2	ASSIGN ALARM RELAYS (2-5)	1 to 4	1	–	F50	16
25E3	RTD #8 ALARM TEMPERATURE	1 to 250	1	°C	F1	80
25E4	RTD #8 ALARM EVENTS	0 to 1	1	–	F105	0
25E5	RTD #8 TRIP	0 to 2	1	–	F115	0
25E6	RTD #8 TRIP VOTING	1 to 12	1	–	F122	8
25E7	ASSIGN TRIP RELAYS (1-4)	0 to 3	1	–	F50	1
25E8	RTD #8 TRIP TEMPERATURE	1 to 250	1	°C	F1	90
25E9	RTD #8 NAME	0 to 8	1	–	F22	–
RTD TEMPERATURE / RTD #9						
2620	RTD #9 APPLICATION	0 to 4	1	–	F121	2
2621	RTD #9 ALARM	0 to 2	1	–	F115	0
2622	ASSIGN ALARM RELAYS (2-5)	1 to 4	1	–	F50	16
2623	RTD #9 ALARM TEMPERATURE	1 to 250	1	°C	F1	80
2624	RTD #9 ALARM EVENTS	0 to 1	1	–	F105	0
2625	RTD #9 TRIP	0 to 2	1	–	F115	0
2626	RTD #9 TRIP VOTING	1 to 12	1	–	F122	9
2627	ASSIGN TRIP RELAYS (1-4)	0 to 3	1	–	F50	1
2628	RTD #9 TRIP TEMPERATURE	1 to 250	1	°C	F1	90
2629	RTD #9 NAME	0 to 8	1	–	F22	–
RTD TEMPERATURE / RTD #10						
2660	RTD #10 APPLICATION	0 to 4	1	–	F121	2
2661	RTD #10 ALARM	0 to 2	1	–	F115	0
2662	ASSIGN ALARM RELAYS (2-5)	1 to 4	1	–	F50	16
2663	RTD #10 ALARM TEMPERATURE	1 to 250	1	°C	F1	80
2664	RTD #10 ALARM EVENTS	0 to 1	1	–	F105	0
2665	RTD #10 TRIP	0 to 2	1	–	F115	0
2666	RTD #10 TRIP VOTING	1 to 12	1	–	F122	10
2667	ASSIGN TRIP RELAYS (1-4)	0 to 3	1	–	F50	1
2668	RTD #10 TRIP TEMPERATURE	1 to 250	1	°C	F1	90
2669	RTD #10 NAME	0 to 8	1	–	F22	–
RTD TEMPERATURE / RTD #11						
26A0	RTD #11 APPLICATION	0 to 4	1	–	F121	4
26A1	RTD #11 ALARM	0 to 2	1	–	F115	0
26A2	ASSIGN ALARM RELAYS (2-5)	1 to 4	1	–	F50	16

1, 2, 3 See Table footnotes on page 6–39

Table 6–1: 489 MEMORY MAP (Sheet 22 of 29)

ADDR	NAME	RANGE	STEP	UNITS	FORMAT	DEFAULT
26A3	RTD #11 ALARM TEMPERATURE	1 to 250	1	°C	F1	80
26A4	RTD #11 ALARM EVENTS	0 to 1	1	–	F105	0
26A5	RTD #11 TRIP	0 to 2	1	–	F115	0
26A6	RTD #11 TRIP VOTING	1 to 12	1	–	F122	11
26A7	ASSIGN TRIP RELAYS (1-4)	0 to 3	1	–	F50	1
26A8	RTD #11 TRIP TEMPERATURE	1 to 250	1	°C	F1	90
26A9	RTD #11 NAME	0 to 8	1	–	F22	–
RTD TEMPERATURE / RTD #12						
26E0	RTD #12 APPLICATION	0 to 4	1	–	F121	3
26E1	RTD #12 ALARM	0 to 2	1	–	F115	0
26E2	ASSIGN ALARM RELAYS (2-5)	1 to 4	1	–	F50	16
26E3	RTD #12 ALARM TEMPERATURE	1 to 250	1	°C	F1	60
26E4	RTD #12 ALARM EVENTS	0 to 1	1	–	F105	0
26E5	RTD #12 TRIP	0 to 2	1	–	F115	0
26E6	RTD #12 TRIP VOTING	1 to 12	1	–	F122	12
26E7	ASSIGN TRIP RELAYS (1-4)	0 to 3	1	–	F50	1
26E8	RTD #12 TRIP TEMPERATURE	1 to 250	1	°C	F1	80
26E9	RTD #12 NAME	0 to 8	1	–	F22	–
RTD TEMPERATURE / OPEN RTD SENSOR						
2720	OPEN RTD SENSOR ALARM	0 to 2	1	–	F115	0
2721	ASSIGN ALARM RELAYS (2-5)	1 to 4	1	–	F50	16
2722	OPEN RTD SENSOR ALARM EVENTS	0 to 1	1	–	F105	0
RTD TEMPERATURE / RTD SHORT/LOW TEMP						
2740	RTD SHORT/LOW TEMP ALARM	0 to 2	1	–	F115	0
2741	ASSIGN ALARM RELAYS (2-5)	1 to 4	1	–	F50	16
2742	RTD SHORT/LOW TEMP ALARM EVENTS	0 to 1	1	–	F105	0
THERMAL MODEL / MODEL SETUP						
2800	ENABLE THERMAL MODEL	0 to 1	1	–	F103	0
2801	OVERLOAD PICKUP LEVEL	101 to 125	1	× FLA	F3	101
2802	UNBALANCE BIAS K FACTOR	0 to 12	1	–	F1	0
2803	COOL TIME CONSTANT ONLINE	0 to 500	1	min	F1	15
2804	COOL TIME CONSTANT OFFLINE	0 to 500	1	min	F1	30
2805	HOT/COLD SAFE STALL RATIO	1 to 100	1	–	F3	100
2806	ENABLE RTD BIASING	0 to 1	1	–	F103	0
2807	RTD BIAS MINIMUM	0 to 250	1	°C	F1	40
2808	RTD BIAS CENTER POINT	0 to 250	1	°C	F1	130
2809	RTD BIAS MAXIMUM	0 to 250	1	°C	F1	155
280A	SELECT CURVE STYLE	0 to 2	1	–	F142	0
280B	STANDARD OVERLOAD CURVE NUMBER	1 to 15	1	–	F1	4
280C	TIME TO TRIP AT 1.01 × FLA	5 to 999999	1	s	F10	5
280E	TIME TO TRIP AT 1.05 × FLA	5 to 999999	1	s	F10	5
2810	TIME TO TRIP AT 1.10 × FLA	5 to 999999	1	s	F10	5
2812	TIME TO TRIP AT 1.20 × FLA	5 to 999999	1	s	F10	5
2814	TIME TO TRIP AT 1.30 × FLA	5 to 999999	1	s	F10	5
2816	TIME TO TRIP AT 1.40 × FLA	5 to 999999	1	s	F10	5
2818	TIME TO TRIP AT 1.50 × FLA	5 to 999999	1	s	F10	5
281A	TIME TO TRIP AT 1.75 × FLA	5 to 999999	1	s	F10	5
281C	TIME TO TRIP AT 2.00 × FLA	5 to 999999	1	s	F10	5
281E	TIME TO TRIP AT 2.25 × FLA	5 to 999999	1	s	F10	5
2820	TIME TO TRIP AT 2.50 × FLA	5 to 999999	1	s	F10	5
2822	TIME TO TRIP AT 2.75 × FLA	5 to 999999	1	s	F10	5
2824	TIME TO TRIP AT 3.00 × FLA	5 to 999999	1	s	F10	5
2826	TIME TO TRIP AT 3.25 × FLA	5 to 999999	1	s	F10	5

1, 2, 3 See Table footnotes on page 6–39

Table 6–1: 489 MEMORY MAP (Sheet 23 of 29)

ADDR	NAME	RANGE	STEP	UNITS	FORMAT	DEFAULT
2828	TIME TO TRIP AT 3.50 × FLA	5 to 999999	1	s	F10	5
282A	TIME TO TRIP AT 3.75 × FLA	5 to 999999	1	s	F10	5
282C	TIME TO TRIP AT 4.00 × FLA	5 to 999999	1	s	F10	5
282E	TIME TO TRIP AT 4.25 × FLA	5 to 999999	1	s	F10	5
2830	TIME TO TRIP AT 4.50 × FLA	5 to 999999	1	s	F10	5
2832	TIME TO TRIP AT 4.75 × FLA	5 to 999999	1	s	F10	5
2834	TIME TO TRIP AT 5.00 × FLA	5 to 999999	1	s	F10	5
2836	TIME TO TRIP AT 5.50 × FLA	5 to 999999	1	s	F10	5
2838	TIME TO TRIP AT 6.00 × FLA	5 to 999999	1	s	F10	5
283A	TIME TO TRIP AT 6.50 × FLA	5 to 999999	1	s	F10	5
283C	TIME TO TRIP AT 7.00 × FLA	5 to 999999	1	s	F10	5
283E	TIME TO TRIP AT 7.50 × FLA	5 to 999999	1	s	F10	5
2840	TIME TO TRIP AT 8.00 × FLA	5 to 999999	1	s	F10	5
2842	TIME TO TRIP AT 10.0 × FLA	5 to 999999	1	s	F10	5
2844	TIME TO TRIP AT 15.0 × FLA	5 to 999999	1	s	F10	5
2846	TIME TO TRIP AT 20.0 × FLA	5 to 999999	1	s	F10	5
2848	MINIMUM ALLOWABLE VOLTAGE	70 to 95	1	%	F1	80
2849	STALL CURRENT @ MIN VOLTAGE	200 to 1500	1	× FLA	F3	480
284A	SAFE STALL TIME @ MIN VOLTAGE	5 to 9999	1	s	F2	200
284B	ACCEL. INTERSECT @ MIN VOLT	200 to 1500	1	× FLA	F3	380
284C	STALL CURRENT @ 100% VOLTAGE	200 to 1500	1	× FLA	F3	600
284D	SAFE STALL TIME @ 100% VOLTAGE	5 to 9999	1	s	F2	100
284E	ACCEL. INTERSECT @ 100% VOLT	200 to 1500	1	× FLA	F3	500
THERMAL MODEL / THERMAL ELEMENTS						
2900	THERMAL MODEL ALARM	0 to 2	1	–	F115	0
2901	ASSIGN ALARM RELAYS (2-5)	1 to 4	1	–	F50	16
2902	THERMAL ALARM LEVEL	10 to 100	1	%Used	F1	75
2903	THERMAL MODEL ALARM EVENTS	0 to 1	1	–	F105	0
2904	THERMAL MODEL TRIP	0 to 2	1	–	F115	0
2905	ASSIGN TRIP RELAYS (1-4)	0 to 3	1	–	F50	1
MONITORING / TRIP COUNTER						
2A00	TRIP COUNTER ALARM	0 to 2	1	–	F115	0
2A01	ASSIGN ALARM RELAYS (2-5)	1 to 4	1	–	F50	16
2A02	TRIP COUNTER ALARM LEVEL	1 to 50000	1	Trips	F1	25
2A03	TRIP COUNTER ALARM EVENTS	0 to 1	1	–	F105	0
MONITORING / BREAKER FAILURE						
2A20	BREAKER FAILURE ALARM	0 to 2	1	–	F115	0
2A21	ASSIGN ALARM RELAYS (2-5)	1 to 4	1	–	F50	16
2A22	BREAKER FAILURE LEVEL	5 to 2000	1	× CT	F3	100
2A23	BREAKER FAILURE DELAY	10 to 1000	10	ms	F1	100
2A24	BREAKER FAILURE ALARM EVENTS	0 to 1	1	–	F105	0
MONITORING / TRIP COIL MONITOR						
2A30	TRIP COIL MONITOR ALARM	0 to 2	1	–	F115	0
2A31	ASSIGN ALARM RELAYS (2-5)	1 to 4	1	–	F50	16
2A32	TRIP COIL MONITOR ALARM EVENTS	0 to 1	1	–	F105	0
MONITORING / VT FUSE FAILURE						
2A50	VT FUSE FAILURE ALARM	0 to 2	1	–	F115	0
2A51	ASSIGN ALARM RELAYS (2-5)	1 to 4	1	–	F50	16
2A52	VT FUSE FAILURE ALARM EVENTS	0 to 1	1	–	F105	0
MONITORING / CURRENT DEMAND						
2A60	CURRENT DEMAND PERIOD	5 to 90	1	min	F1	15
2A61	CURRENT DEMAND ALARM	0 to 2	1	A	F115	0
2A62	ASSIGN ALARM RELAYS (2-5)	1 to 4	1	A	F50	16

1, 2, 3 See Table footnotes on page 6–39

Table 6–1: 489 MEMORY MAP (Sheet 24 of 29)

ADDR	NAME	RANGE	STEP	UNITS	FORMAT	DEFAULT
2A63	CURRENT DEMAND LIMIT	10 to 2000	1	× FLA	F14	125
2A65	CURRENT DEMAND ALARM EVENTS	0 to 1	1	A	F105	0
MONITORING / MW DEMAND						
2A70	MW DEMAND PERIOD	5 to 90	1	min	F1	15
2A71	MW DEMAND ALARM	0 to 2	1	–	F115	0
2A72	ASSIGN ALARM RELAYS (2-5)	1 to 4	1	–	F50	16
2A73	MW DEMAND LIMIT	10 to 200	1	× Rated	F14	125
2A75	MW DEMAND ALARM EVENTS	0 to 1	1	–	F105	0
MONITORING / Mvar DEMAND						
2A80	Mar DEMAND PERIOD	5 to 90	1	min	F1	15
2A81	Mar DEMAND ALARM	0 to 2	1	–	F115	0
2A82	ASSIGN ALARM RELAYS (2-5)	1 to 4	1	–	F50	16
2A83	Mar DEMAND LIMIT	10 to 200	1	× Rated	F14	125
2A85	Mar DEMAND ALARM EVENTS	0 to 1	1	–	F105	0
MONITORING / MVA DEMAND						
2A90	MVA DEMAND PERIOD	5 to 90	1	min	F1	15
2A91	MVA DEMAND ALARM	0 to 2	1	–	F115	0
2A92	ASSIGN ALARM RELAYS (2-5)	1 to 4	1	–	F50	16
2A93	MVA DEMAND LIMIT	10 to 200	1	× Rated	F14	125
2A95	MVA DEMAND ALARM EVENTS	0 to 1	1	–	F105	0
MONITORING / PULSE OUTPUT						
2AB0	POS. kWh PULSE OUT RELAYS (2-5)	1 to 4	1	–	F50	0
2AB1	POS. kWh PULSE OUT INTERVAL	1 to 50000	1	–	F1	10
2AB2	POS. kvarh PULSE OUT RELAYS (2-5)	1 to 4	1	–	F50	0
2AB3	POS. kvarh PULSE OUT INTERVAL	1 to 50000	1	–	F1	10
2AB4	NEG. kvarh PULSE OUT RELAYS (2-5)	1 to 4	1	–	F50	0
2AB5	NEG. kvarh PULSE OUT INTERVAL	1 to 50000	1	–	F1	10
2AB6	PULSE WIDTH	200 to 1000	1	–	F1	200
MONITORING / RUNNING HOUR SETUP						
2AC0	INITIAL GEN. RUNNING HOUR	0 to 999999	1	h	F12	0
2AC2	GEN. RUNNING HOUR ALARM	0 to 2	1	–	F115	0
2AC3	ASSIGN ALARM RELAYS (2-5)	1 to 4	1	–	F50	16
2AC4	GEN. RUNNING HOUR LIMIT	1 to 1000000	1	h	F12	1000
2AC6	RESERVED					
ANALOG I/O / ANALOG OUTPUT 1						
2B00	ANALOG OUTPUT 1	0 to 42	1	–	F127	0
ANALOG I/O / ANALOG OUTPUT 2						
2B01	ANALOG OUTPUT 2	0 to 42	1	–	F127	0
ANALOG I/O / ANALOG OUTPUT 3						
2B02	ANALOG OUTPUT 3	0 to 42	1	–	F127	0
ANALOG I/O / ANALOG OUTPUT 4						
2B03	ANALOG OUTPUT 4	0 to 42	1	–	F127	0
ANALOG I/O / ANALOG OUTPUTS						
2B04	IA OUTPUT CURRENT MIN	0 to 2000	1	× FLA	F3	0
2B05	IA OUTPUT CURRENT MAX	0 to 2000	1	× FLA	F3	125
2B06	IB OUTPUT CURRENT MIN	0 to 2000	1	× FLA	F3	0
2B07	IB OUTPUT CURRENT MAX	0 to 2000	1	× FLA	F3	125
2B08	IC OUTPUT CURRENT MIN	0 to 2000	1	× FLA	F3	0
2B09	IC OUTPUT CURRENT MAX	0 to 2000	1	× FLA	F3	125
2B0A	AVG OUTPUT CURRENT MIN	0 to 2000	1	× FLA	F3	0
2B0B	AVG OUTPUT CURRENT MAX	0 to 2000	1	× FLA	F3	125
2B0C	NEG. SEQ. CURRENT MIN	0 to 2000	1	%FLA	F1	0
2B0D	NEG. SEQ. CURRENT MAX	0 to 2000	1	%FLA	F1	100

1, 2, 3 See Table footnotes on page 6–39

Table 6–1: 489 MEMORY MAP (Sheet 25 of 29)

ADDR	NAME	RANGE	STEP	UNITS	FORMAT	DEFAULT
2B0E	AVERAGED GEN. LOAD MIN	0 to 2000	1	× FLA	F3	0
2B0F	AVERAGED GEN. LOAD MAX	0 to 2000	1	× FLA	F3	125
2B10	HOTTEST STATOR RTD MIN	–50 to 250	1	°C	F4	0
2B11	HOTTEST STATOR RTD MAX	–50 to 250	1	°C	F4	200
2B12	HOTTEST BEARING RTD MIN	–50 to 250	1	°C	F4	0
2B13	HOTTEST BEARING RTD MAX	–50 to 250	1	°C	F4	200
2B14	AMBIENT RTD MIN	–50 to 250	1	°C	F4	0
2B15	AMBIENT RTD MAX	–50 to 250	1	°C	F4	70
2B16	RTD #1 MIN	–50 to 250	1	°C	F4	0
2B17	RTD #1 MAX	–50 to 250	1	°C	F4	200
2B18	RTD #2 MIN	–50 to 250	1	°C	F4	0
2B19	RTD #2 MAX	–50 to 250	1	°C	F4	200
2B1A	RTD #3 MIN	–50 to 250	1	°C	F4	0
2B1B	RTD #3 MAX	–50 to 250	1	°C	F4	200
2B1C	RTD #4 MIN	–50 to 250	1	°C	F4	0
2B1D	RTD #4 MAX	–50 to 250	1	°C	F4	200
2B1E	RTD #5 MIN	–50 to 250	1	°C	F4	0
2B1F	RTD #5 MAX	–50 to 250	1	°C	F4	200
2B20	RTD #6 MIN	–50 to 250	1	°C	F4	0
2B21	RTD #6 MAX	–50 to 250	1	°C	F4	200
2B22	RTD #7 MIN	–50 to 250	1	°C	F4	0
2B23	RTD #7 MAX	–50 to 250	1	°C	F4	200
2B24	RTD #8 MIN	–50 to 250	1	°C	F4	0
2B25	RTD #8 MAX	–50 to 250	1	°C	F4	200
2B26	RTD #9 MIN	–50 to 250	1	°C	F4	0
2B27	RTD #9 MAX	–50 to 250	1	°C	F4	200
2B28	RTD #10 MIN	–50 to 250	1	°C	F4	0
2B29	RTD #10 MAX	–50 to 250	1	°C	F4	200
2B2A	RTD #11 MIN	–50 to 250	1	°C	F4	0
2B2B	RTD #11 MAX	–50 to 250	1	°C	F4	200
2B2C	RTD #12 MIN	–50 to 250	1	°C	F4	0
2B2D	RTD #12 MAX	–50 to 250	1	°C	F4	200
2B2E	AB VOLTAGE MIN	0 to 150	1	× Rated	F3	0
2B2F	AB VOLTAGE MAX	0 to 150	1	× Rated	F3	125
2B30	BC VOLTAGE MIN	0 to 150	1	× Rated	F3	0
2B31	BC VOLTAGE MAX	0 to 150	1	× Rated	F3	125
2B32	CA VOLTAGE MIN	0 to 150	1	× Rated	F3	0
2B33	CA VOLTAGE MAX	0 to 150	1	× Rated	F3	125
2B34	AVERAGE VOLTAGE MIN	0 to 150	1	× Rated	F3	0
2B35	AVERAGE VOLTAGE MAX	0 to 150	1	× Rated	F3	125
2B36	VOLTS/HERTZ MIN	0 to 200	1	× Rated	F3	0
2B37	VOLTS/HERTZ MAX	0 to 200	1	× Rated	F3	150
2B38	FREQUENCY MIN	0 to 9000	1	Hz	F3	5900
2B39	FREQUENCY MAX	0 to 9000	1	Hz	F3	6100
2B3C	POWER FACTOR MIN	–99 to 100	1	–	F6	80
2B3D	POWER FACTOR MAX	–99 to 100	1	–	F6	–80
2B3E	REACTIVE POWER MIN	–200 to 200	1	× Rated	F6	0
2B3F	REACTIVE POWER MAX	–200 to 200	1	× Rated	F6	125
2B40	REAL POWER (MW) MIN	–200 to 200	1	× Rated	F6	0
2B41	REAL POWER (MW) MAX	–200 to 200	1	× Rated	F6	125
2B42	APPARENT POWER MIN	0 to 200	1	× Rated	F3	0
2B43	APPARENT POWER MAX	0 to 200	1	× Rated	F3	125
2B44	ANALOG INPUT 1 MIN	–50000 to 50000	1	Units	F12	0

1, 2, 3 See Table footnotes on page 6–39

Table 6–1: 489 MEMORY MAP (Sheet 26 of 29)

ADDR	NAME	RANGE	STEP	UNITS	FORMAT	DEFAULT
2B46	ANALOG INPUT 1 MAX	–50000 to 50000	1	Units	F12	50000
2B48	ANALOG INPUT 2 MIN	–50000 to 50000	1	Units	F12	0
2B4A	ANALOG INPUT 2 MAX	–50000 to 50000	1	Units	F12	50000
2B4C	ANALOG INPUT 3 MIN	–50000 to 50000	1	Units	F12	0
2B4E	ANALOG INPUT 3 MAX	–50000 to 50000	1	Units	F12	50000
2B50	ANALOG INPUT 4 MIN	–50000 to 50000	1	Units	F12	0
2B52	ANALOG INPUT 4 MAX	–50000 to 50000	1	Units	F12	50000
2B54	TACHOMETER MIN	0 to 7200	1	RPM	F1	3500
2B55	TACHOMETER MAX	0 to 7200	1	RPM	F1	3700
2B56	THERM. CAPACITY USED MIN	0 to 100	1	%	F1	0
2B57	THERM. CAPACITY USED MAX	0 to 100	1	%	F1	100
2B58	NEUTRAL VOLT THIRD MIN	0 to 250000	1	Volts	F10	0
2B5A	NEUTRAL VOLT THIRD MAX	0 to 250000	1	Volts	F10	450
2B5C	CURRENT DEMAND MIN	0 to 2000	1	× FLA	F3	0
2B5D	CURRENT DEMAND MAX	0 to 2000	1	× FLA	F3	125
2B5E	Mar DEMAND MIN	0 to 200	1	× Rated	F3	0
2B5F	Mar DEMAND MAX	0 to 200	1	× Rated	F3	125
2B60	MW DEMAND MIN	0 to 200	1	× Rated	F3	0
2B61	MW DEMAND MAX	0 to 200	1	× Rated	F3	125
2B62	MVA DEMAND MIN	0 to 200	1	× Rated	F3	0
2B63	MVA DEMAND MAX	0 to 200	1	× Rated	F3	125
ANALOG I/O / ANALOG INPUT 1						
2C00	ANALOG INPUT1	0 to 3	1	–	F129	0
2C05	ANALOG INPUT1 UNITS	0 to 6	1	–	F22	–
2C08	ANALOG INPUT1 MINIMUM	–50000 to 50000	1	Units	F12	0
2C0A	ANALOG INPUT1 MAXIMUM	–50000 to 50000	1	Units	F12	100
2C0C	BLOCK ANALOG INPUT1 FROM ONLINE	0 to 5000	1	s	F1	0
2C0D	ANALOG INPUT1 ALARM	0 to 2	1	–	F115	0
2C0E	ASSIGN ALARM RELAYS (2-5)	1 to 4	1	–	F50	16
2C0F	ANALOG INPUT1 ALARM LEVEL	–50000 to 50000	1	Units	F12	10
2C11	ANALOG INPUT1 ALARM PICKUP	0 to 1	1	–	F130	0
2C12	ANALOG INPUT1 ALARM DELAY	1 to 3000	1	s	F2	1
2C13	ANALOG INPUT1 ALARM EVENTS	0 to 1	1	–	F105	0
2C14	ANALOG INPUT1 TRIP	0 to 2	1	–	F115	0
2C15	ASSIGN TRIP RELAYS (1-4)	0 to 3	1	–	F50	1
2C16	ANALOG INPUT1 TRIP LEVEL	–50000 to 50000	1	Units	F12	20
2C18	ANALOG INPUT1 TRIP PICKUP	0 to 1	1	–	F130	0
2C19	ANALOG INPUT1 TRIP DELAY	1 to 3000	1	s	F2	1
2C1A	ANALOG INPUT1 NAME	0 to 12	1	–	F22	–
ANALOG I/O / ANALOG INPUT 2						
2C40	ANALOG INPUT2	0 to 3	1	–	F129	0
2C45	ANALOG INPUT2 UNITS	0 to 6	1	–	F22	–
2C48	ANALOG INPUT2 MINIMUM	–50000 to 50000	1	Units	F12	0
2C4A	ANALOG INPUT2 MAXIMUM	–50000 to 50000	1	Units	F12	100
2C4C	BLOCK ANALOG INPUT2 FROM ONLINE	0 to 5000	1	s	F1	0
2C4D	ANALOG INPUT2 ALARM	0 to 2	1	–	F115	0
2C4E	ASSIGN ALARM RELAYS (2-5)	1 to 4	1	–	F50	16
2C4F	ANALOG INPUT2 ALARM LEVEL	–50000 to 50000	1	Units	F12	10
2C51	ANALOG INPUT2 ALARM PICKUP	0 to 1	1	–	F130	0
2C52	ANALOG INPUT2 ALARM DELAY	1 to 3000	1	s	F2	1
2C53	ANALOG INPUT2 ALARM EVENTS	0 to 1	1	–	F105	0
2C54	ANALOG INPUT2 TRIP	0 to 2	1	–	F115	0
2C55	ASSIGN TRIP RELAYS (1-4)	0 to 3	1	–	F50	1

1, 2, 3 See Table footnotes on page 6–39

Table 6–1: 489 MEMORY MAP (Sheet 27 of 29)

ADDR	NAME	RANGE	STEP	UNITS	FORMAT	DEFAULT
2C56	ANALOG INPUT2 TRIP LEVEL	–50000 to 50000	1	Units	F12	20
2C58	ANALOG INPUT2 TRIP PICKUP	0 to 1	1	–	F130	0
2C59	ANALOG INPUT2 TRIP DELAY	1 to 3000	1	s	F2	1
2C5A	ANALOG INPUT2 NAME	0 to 12	1	–	F22	–
ANALOG I/O / ANALOG INPUT 3						
2C80	ANALOG INPUT3	0 to 3	1	–	F129	0
2C85	ANALOG INPUT3 UNITS	0 to 6	1	–	F22	–
2C88	ANALOG INPUT3 MINIMUM	–50000 to 50000	1	Units	F12	0
2C8A	ANALOG INPUT3 MAXIMUM	–50000 to 50000	1	Units	F12	100
2C8C	BLOCK ANALOG INPUT3 FROM ONLINE	0 to 5000	1	s	F1	0
2C8D	ANALOG INPUT3 ALARM	0 to 2	1	–	F115	0
2C8E	ASSIGN ALARM RELAYS (2-5)	1 to 4	1	–	F50	16
2C8F	ANALOG INPUT3 ALARM LEVEL	–50000 to 50000	1	Units	F12	10
2C91	ANALOG INPUT3 ALARM PICKUP	0 to 1	1	–	F130	0
2C92	ANALOG INPUT3 ALARM DELAY	1 to 3000	1	s	F2	1
2C93	ANALOG INPUT3 ALARM EVENTS	0 to 1	1	–	F105	0
2C94	ANALOG INPUT3 TRIP	0 to 2	1	–	F115	0
2C95	ASSIGN TRIP RELAYS (1-4)	0 to 3	1	–	F50	1
2C96	ANALOG INPUT3 TRIP LEVEL	–50000 to 50000	1	Units	F12	20
2C98	ANALOG INPUT3 TRIP PICKUP	0 to 1	1	–	F130	0
2C99	ANALOG INPUT3 TRIP DELAY	1 to 3000	1	s	F2	1
2C9A	ANALOG INPUT3 NAME	0 to 12	1	–	F22	–
ANALOG I/O / ANALOG INPUT 4						
2CC0	ANALOG INPUT4	0 to 3	1	–	F129	0
2CC5	ANALOG INPUT4 UNITS	0 to 6	1	–	F22	–
2CC8	ANALOG INPUT4 MINIMUM	–50000 to 50000	1	Units	F12	0
2CCA	ANALOG INPUT4 MAXIMUM	–50000 to 50000	1	Units	F12	100
2CCC	BLOCK ANALOG INPUT4 FROM ONLINE	0 to 5000	1	s	F1	0
2CCD	ANALOG INPUT4 ALARM	0 to 2	1	–	F115	0
2CCE	ASSIGN ALARM RELAYS (2-5)	1 to 4	1	–	F50	16
2CCF	ANALOG INPUT4 ALARM LEVEL	–50000 to 50000	1	Units	F12	10
2CD1	ANALOG INPUT4 ALARM PICKUP	0 to 1	1	–	F130	0
2CD2	ANALOG INPUT4 ALARM DELAY	1 to 3000	1	s	F2	1
2CD3	ANALOG INPUT4 ALARM EVENTS	0 to 1	1	–	F105	0
2CD4	ANALOG INPUT4 TRIP	0 to 2	1	–	F115	0
2CD5	ASSIGN TRIP RELAYS (1-4)	0 to 3	1	–	F50	1
2CD6	ANALOG INPUT4 TRIP LEVEL	–50000 to 50000	1	Units	F12	20
2CD8	ANALOG INPUT4 TRIP PICKUP	0 to 1	1	–	F130	0
2CD9	ANALOG INPUT4 TRIP DELAY	1 to 3000	1	s	F2	1
2CDA	ANALOG INPUT4 NAME	0 to 12	1	–	F22	–
489 TESTING / SIMULATION MODE						
2D00	SIMULATION MODE	0 to 3	1	–	F138	0
2D01	PRE-FAULT TO FAULT TIME DELAY	0 to 300	1	s	F1	15
489 TESTING / PRE-FAULT SETUP						
2D20	PRE-FAULT I _{phase} OUTPUT	0 to 2000	1	× CT	F3	0
2D21	PRE-FAULT VOLTAGES PHASE-N	0 to 150	1	× Rated	F3	100
2D22	PRE-FAULT CURRENT LAGS VOLTAGE	0 to 359	1	°	F1	0
2D23	PRE-FAULT I _{phase} NEUTRAL	0 to 2000	1	× CT	F3	0
2D24	PRE-FAULT CURRENT GROUND	0 to 2000	1	× CT	F3	0
2D25	PRE-FAULT VOLTAGE NEUTRAL	0 to 1000	1	Volts	F2	0
2D26	PRE-FAULT STATOR RTD TEMP	–50 to 250	1	°C	F4	40
2D27	PRE-FAULT BEARING RTD TEMP	–50 to 250	1	°C	F4	40
2D28	PRE-FAULT OTHER RTD TEMP	–50 to 250	1	°C	F4	40

1, 2, 3 See Table footnotes on page 6–39

Table 6–1: 489 MEMORY MAP (Sheet 28 of 29)

ADDR	NAME	RANGE	STEP	UNITS	FORMAT	DEFAULT
2D29	PRE-FAULT AMBIENT RTD TEMP	–50 to 250	1	°C	F4	40
2D2A	PRE-FAULT SYSTEM FREQUENCY	50 to 900	1	Hz	F2	600
2D2B	PRE-FAULT ANALOG INPUT 1	0 to 100	1	%	F1	0
2D2C	PRE-FAULT ANALOG INPUT 2	0 to 100	1	%	F1	0
2D2D	PRE-FAULT ANALOG INPUT 3	0 to 100	1	%	F1	0
2D2E	PRE-FAULT ANALOG INPUT 4	0 to 100	1	%	F1	0
2D4C	PRE-FAULT STATOR RTD TEMP	–50 to 250	1	°F	F4	40
2D4D	PRE-FAULT BEARING RTD TEMP	–50 to 250	1	°F	F4	40
2D4E	PRE-FAULT OTHER RTD TEMP	–50 to 250	1	°F	F4	40
2D4F	PRE-FAULT AMBIENT RTD TEMP	–50 to 250	1	°F	F4	40
489 TESTING / FAULT SETUP						
2D80	FAULT I _{phase} OUTPUT	0 to 2000	1	× CT	F3	0
2D81	FAULT VOLTAGES PHASE-N	0 to 150	1	× Rated	F3	100
2D82	FAULT CURRENT LAGS VOLTAGE	0 to 359	1	°	F1	0
2D83	FAULT I _{phase} NEUTRAL	0 to 2000	1	× CT	F3	0
2D84	FAULT CURRENT GROUND	0 to 2000	1	× CT	F3	0
2D85	FAULT VOLTAGE NEUTRAL	0 to 1000	1	Volts	F2	0
2D86	FAULT STATOR RTD TEMP	–50 to 250	1	°C	F4	40
2D87	FAULT BEARING RTD TEMP	–50 to 250	1	°C	F4	40
2D88	FAULT OTHER RTD TEMP	–50 to 250	1	°C	F4	40
2D89	FAULT AMBIENT RTD TEMP	–50 to 250	1	°C	F4	40
2D8A	FAULT SYSTEM FREQUENCY	50 to 900	1	Hz	F2	600
2D8B	FAULT ANALOG INPUT 1	0 to 100	1	%	F1	0
2D8C	FAULT ANALOG INPUT 2	0 to 100	1	%	F1	0
2D8D	FAULT ANALOG INPUT 3	0 to 100	1	%	F1	0
2D8E	FAULT ANALOG INPUT 4	0 to 100	1	%	F1	0
2DBC	FAULT STATOR RTD TEMP	–50 to 250	1	°F	F4	40
2DBD	FAULT BEARING RTD TEMP	–50 to 250	1	°F	F4	40
2DBE	FAULT OTHER RTD TEMP	–50 to 250	1	°F	F4	40
2DBF	FAULT AMBIENT RTD TEMP	–50 to 250	1	°F	F4	40
489 TESTING / TEST OUTPUT RELAYS						
2DE0	FORCE OPERATION OF RELAYS	0 to 8	1	–	F139	0
489 TESTING / TEST ANALOG OUTPUT						
2DF0	FORCE ANALOG OUTPUTS FUNCTION	0 to 1	1	–	F126	0
2DF1	ANALOG OUTPUT 1 FORCED VALUE	0 to 100	1	%	F1	0
2DF2	ANALOG OUTPUT 2 FORCED VALUE	0 to 100	1	%	F1	0
2DF3	ANALOG OUTPUT 3 FORCED VALUE	0 to 100	1	%	F1	0
2DF4	ANALOG OUTPUT 4 FORCED VALUE	0 to 100	1	%	F1	0
EVENT RECORDER / GENERAL						
3000	EVENT RECORDER LAST RESET DATE (2 WORDS)	N/A	N/A	N/A	F18	N/A
3002	TOTAL NUMBER OF EVENTS SINCE LAST CLEAR	0 to 65535	1	N/A	F1	N/A
3003	EVENT RECORD SELECTOR	0 to 65535	1	–	F1	0
EVENT RECORDER / SELECTED EVENT						
3004	CAUSE OF EVENT	0 to 139	1	–	F134	0
3005	TIME OF EVENT (2 WORDS)	N/A	N/A	N/A	F19	N/A
3007	DATE OF EVENT (2 WORDS)	N/A	N/A	N/A	F18	N/A
3009	TACHOMETER	0 to 7200	1	RPM	F1	0
300A	PHASE A CURRENT	0 to 999999	1	Amps	F12	0
300C	PHASE B CURRENT	0 to 999999	1	Amps	F12	0
300E	PHASE C CURRENT	0 to 999999	1	Amps	F12	0
3010	PHASE A DIFFERENTIAL CURRENT	0 to 999999	1	Amps	F12	0
3012	PHASE B DIFFERENTIAL CURRENT	0 to 999999	1	Amps	F12	0
3014	PHASE C DIFFERENTIAL CURRENT	0 to 999999	1	Amps	F12	0

1, 2, 3 See Table footnotes on page 6–39

Table 6–1: 489 MEMORY MAP (Sheet 29 of 29)

ADDR	NAME	RANGE	STEP	UNITS	FORMAT	DEFAULT
3016	NEG. SEQ. CURRENT	0 to 2000	1	%FLA	F1	0
3017	GROUND CURRENT	0 to 20000000	1	A	F14	0
3019	A-B VOLTAGE	0 to 50000	1	Volts	F1	0
301A	B-C VOLTAGE	0 to 50000	1	Volts	F1	0
301B	C-A VOLTAGE	0 to 50000	1	Volts	F1	0
301C	FREQUENCY	0 to 12000	1	Hz	F3	0
301D	ACTIVE GROUP	0 to 1	1	–	F1	0
301F	REAL POWER (MW)	–2000000 to 2000000	1	MW	F13	0
3021	REACTIVE POWER Mar	–2000000 to 2000000	1	Mar	F13	0
3023	APPARENT POWER MVA	0 to 2000000	1	MVA	F13	0
3025	HOTTEST STATOR RTD #	1 to 12	1	–	F1	1
3026	HOTTEST STATOR RTD TEMPERATURE	–50 to 250	1	°C	F4	0
3027	HOTTEST BEARING RTD #	1 to 12	1	–	F1	1
3028	HOTTEST BEARING RTD TEMPERATURE	–50 to 250	1	°C	F4	0
3029	HOTTEST OTHER RTD #	1 to 12	1	–	F1	1
302A	HOTTEST OTHER RTD TEMPERATURE	–50 to 250	1	°C	F4	0
302B	HOTTEST AMBIENT RTD #	1 to 12	1	–	F1	1
302C	HOTTEST AMBIENT RTD TEMPERATURE	–50 to 250	1	°C	F4	0
302D	ANALOG IN 1	–50000 to 50000	1	Units	F12	0
302F	ANALOG IN 2	–50000 to 50000	1	Units	F12	0
3031	ANALOG IN 3	–50000 to 50000	1	Units	F12	0
3033	ANALOG IN 4	–50000 to 50000	1	Units	F12	0
3035	PHASE A NEUTRAL CURRENT	0 to 999999	1	Amps	F12	0
3037	PHASE B NEUTRAL CURRENT	0 to 999999	1	Amps	F12	0
3039	PHASE C NEUTRAL CURRENT	0 to 999999	1	Amps	F12	0
30E0	HOTTEST STATOR RTD TEMPERATURE	–50 to 250	1	°F	F4	0
30E1	HOTTEST BEARING RTD TEMPERATURE	–50 to 250	1	°F	F4	0
30E2	HOTTEST OTHER RTD TEMPERATURE	–50 to 250	1	°F	F4	0
30E3	HOTTEST AMBIENT RTD TEMPERATURE	–50 to 250	1	°F	F4	0
30E5	NEUTRAL VOLT (FUND)	0 to 250000	1	Volts	F10	0
30E7	NEUTRAL VOLT (3rd)	0 to 250000	1	Volts	F10	0
30E9	Vab/lab	0 to 65535	1	ohms s	F1	0
30EA	Vab/lab ANGLE	0 to 359	1	°	F1	0
WAVEFORM MEMORY SETUP						
30F0	WAVEFORM MEMORY TRIGGER DATE	N/A	N/A	N/A	F18	N/A
30F2	WAVEFORM MEMORY TRIGGER TIME	N/A	N/A	N/A	F19	N/A
30F4	FREQUENCY DURING TRACE ACQUISITION	0 to 12000	1	Hz	F3	0
30F5	WAVEFORM MEMORY CHANNEL SELECTOR (HOLDING REGISTER)	0 to 9	1	N/A	F214	0
30F6	WAVEFORM TRIGGER SELECTOR	1 to 65535	1	N/A	F1	0
30F7	WAVEFORM TRIGGER CAUSE (READ-ONLY)	0 to 139	1	N/A	F134	0
30F8	NUMBER OF SAMPLES PER WAVEFORM CAPTURE	1 to 768	1	N/A	F1	168
30F9	NUMBER OF WAVEFORM CAPTURES TAKEN	0 to 65535	1	N/A	F1	0
WAVEFORM MEMORY SAMPLES						
3100	FIRST WAVEFORM MEMORY SAMPLE	–32767 to 32767	1	N/A	F4	0
3400	LAST WAVEFORM MEMORY SAMPLE	–32767 to 32767	1	N/A	F4	0

1, 2, 3 See Table footnotes on page 6–39

1. Value of 65535 indicates 'Never'
2. A value of 0xFFFF indicates "no measurable value".
3. Maximum value turns feature 'Off'

6.3.8 MEMORY MAP DATA FORMATS

Table 6–2: DATA FORMATS (Sheet 1 of 5)

FORMAT CODE	TYPE	DEFINITION
F1	16 bits	Unsigned Value Example: 1234 stored as 1234
F2	16 bits	Unsigned Value, 1 Decimal Place Example: 123.4 stored as 1234
F3	16 bits	Unsigned Value, 2 Decimal Places Example: 12.34 stored as 1234
F4	16 bits	2's Complement Signed Value Example, -1234 stored as -1234 (i.e., 64302)
F5	16 bits	2's Complement Signed Value, 1 Decimal Place Example, -1.234 stored as -1234 (i.e., 64302)
F6	16 bits	2's Complement Signed Value, 2 Decimal Places Example, -12.34 stored as -1234 (i.e., 64302)
F10	32 bits	2's Complement Signed Long Value, 1 Decimal Place 1st 16 bits: High order word of long value 2nd 16 bits: Low order word of long value Example: -12345.6 stored as -123456 (i.e., 1st word FFFE hex, 2nd word 1DC0 hex)
F12	32 bits	2's Complement Signed Long Value 1st 16 bits: High order word of long value 2nd 16 bits: Low order word of long value Example: -123456 stored as 1st word FFFE hex, 2nd word 1DC0 hex
F13	32 bits	2's Compliment Signed Long Value, 3 Decimal Places 1st 16 bits: High order word of long value 2nd 16 bits: Low order word of long value Example: -123.456 stored as -123456 (i.e., 1st word FFFE hex, 2nd word 1DC0 hex)
F14	32 bits	2's Complement Signed Long Value, 2 Decimal Places 1st 16 bits: High order word of long value 2nd 16 bits: Low order word of long value Example: -1234.56 stored as -123456 (i.e., 1st word FFFE hex, 2nd word 1DC0 hex)
F15	16 bits	Hardware Revision 1 = revision A, 2 = revision B, 3 = revision C, ..., 26 = revision Z
F16	16 bits	Software Revision 1111 1111 XXXX XXXX: Major revision number – 0 to 9 in steps of 1 XXXX XXXX 1111 1111: Minor revision number (two BCD digits) 00 to 99 in steps of 1 Example: Revision 2.30 stored as 0230 hex
F18	32 bits	Date (MM/DD/YYYY) 1st byte: Month (1 to 12) 2nd byte: Day (1 to 31) 3rd and 4th byte: Year (1996 to 2094) Example: Feb. 20, 1996 stored as 34867148 (i.e., first word 0214, 2nd word 07CC)
F19	32 bits	Time (HH:MM:SS:hh) 1st byte: Hours (0 to 23) 2nd byte: Minutes (0 to 59) 3rd byte: Seconds (0 to 59) 4th byte: Hundredths of seconds (0 to 99) Example: 2:05pm stored as 235208704 (i.e., 1st word 0E05, 2nd word 0000)
F22	16 bits	Character String (Note: Range indicates number of characters) 1st byte (MSB) of each word: First of a pair of characters 2nd byte (LSB) of each word: Second of a pair of characters Example: String "AB" stored as 4142 hex
F24	32 bits	Time Format for Broadcast 1st byte: Hours (0 to 23) 2nd byte: Minutes (0 to 59) 3rd and 4th bytes: Milliseconds (0 to 59999). Note: Clock resolution limited to 1/100 sec. Example: 1:15:48:572 stored as 17808828 (i.e., 1st word 010F, 2nd word BDBC)
F50	16 bits	Relay List (Bitmap) Bit 0 = Relay 1, Bit 1 = Relay 2, Bit 2 = Relay 3, Bit 3 = Relay 4, Bit 4 = Relay 5, Bit 5 = Relay 6
F100	Unsigned 16 bit integer	Temperature display units 0 = Celsius, 1 = Fahrenheit
F101	Unsigned 16 bit integer	RS485 baud rate 0 = 300, 1 = 1200, 2 = 2400, 3 = 4800, 4 = 9600, 5 = 19200
F102	Unsigned 16 bit integer	RS485 parity 0 = None, 1 = Odd, 2 = Even
F103	Unsigned 16 bit integer	No / Yes selection 0 = No, 1 = Yes
F104	Unsigned 16 bit integer	Ground CT type 0 = None, 1 = 1 A Secondary, 2 = 50:0.025 Ground CT, 3 = 5 A Secondary
F105	Unsigned 16 bit integer	Off / On selection 0 = Off, 1 = On

Table 6–2: DATA FORMATS (Sheet 2 of 5)

FORMAT CODE	TYPE	DEFINITION																																																																																												
F106	Unsigned 16 bit integer	VT connection type 0 = None, 1 = Open Delta, 2 = Wye																																																																																												
F107	Unsigned 16 bit integer	Nominal frequency selection 0 = -----, 1 = 60 Hz, 2 = 50 Hz, 3 = 25 Hz																																																																																												
F109	Unsigned 16 bit integer	Breaker status switch type 0 = Auxiliary a, 1 = Auxiliary b																																																																																												
F115	Unsigned 16 bit integer	Alarm / trip type selection 0 = Off, 1 = Latched, 2 = Unlatched																																																																																												
F117	Unsigned 16 bit integer	Reset mode 0 = All Resets, 1 = Remote Reset Only																																																																																												
F118	Unsigned 16 bit integer	Setpoint Group 0 = Group 1, 1 = Group 2																																																																																												
F120	Unsigned 16 bit integer	RTD type 0 = 100 Ohm Platinum, 1 = 120 Ohm Nickel, 2 = 100 Ohm Nickel, 3 = 10 Ohm Copper																																																																																												
F121	Unsigned 16 bit integer	RTD application 0 = None, 1 = Stator, 2 = Bearing, 3 = Ambient, 4 = Other																																																																																												
F122	Unsigned 16 bit integer	RTD voting selection 1 = RTD #1, 2 = RTD #2, 3= RTD #3,...., 12 = RTD #12																																																																																												
F123	Unsigned 16 bit integer	Alarm / trip status 0 = Not Enabled, 1 = Inactive, 2 = Timing Out, 3 = Active Trip, 4 = Latched Trip																																																																																												
F124	Unsigned 16 bit integer	Phase rotation selection 0 = ----, 1 = ABC, 2 = ACB																																																																																												
F126	Unsigned 16 bit integer	Disabled / Enabled selection 0 = Disabled, 1 = Enabled																																																																																												
F127	Unsigned 16 bit integer	<p>Analog output parameter selection</p> <table border="1"> <thead> <tr> <th>VALUE</th> <th>PARAMETER</th> <th>VALUE</th> <th>PARAMETER</th> </tr> </thead> <tbody> <tr><td>0</td><td>None</td><td>22</td><td>AB Voltage</td></tr> <tr><td>1</td><td>IA Output Current</td><td>23</td><td>BC Voltage</td></tr> <tr><td>2</td><td>IB Output Current</td><td>24</td><td>CA Voltage</td></tr> <tr><td>3</td><td>IC Output Current</td><td>25</td><td>Average Voltage</td></tr> <tr><td>4</td><td>Avg. Output Current</td><td>26</td><td>Volts / Hertz</td></tr> <tr><td>5</td><td>Neg. Seq. Current</td><td>27</td><td>Frequency</td></tr> <tr><td>6</td><td>Averaged Gen. Load</td><td>28</td><td>Neutral Voltage (3rd)</td></tr> <tr><td>7</td><td>Hottest Stator RTD</td><td>29</td><td>Power Factor</td></tr> <tr><td>8</td><td>Hottest Bearing RTD</td><td>30</td><td>Reactive Power (Mvar)</td></tr> <tr><td>9</td><td>Ambient RTD</td><td>31</td><td>Real Power (MW)</td></tr> <tr><td>10</td><td>RTD #1</td><td>32</td><td>Apparent Power (MVA)</td></tr> <tr><td>11</td><td>RTD #2</td><td>33</td><td>Analog Input 1</td></tr> <tr><td>12</td><td>RTD #3</td><td>34</td><td>Analog Input 2</td></tr> <tr><td>13</td><td>RTD #4</td><td>35</td><td>Analog Input 3</td></tr> <tr><td>14</td><td>RTD #5</td><td>36</td><td>Analog Input 4</td></tr> <tr><td>15</td><td>RTD #6</td><td>37</td><td>Tachometer</td></tr> <tr><td>16</td><td>RTD #7</td><td>38</td><td>Therm. Capacity Used</td></tr> <tr><td>17</td><td>RTD #8</td><td>39</td><td>Current Demand</td></tr> <tr><td>18</td><td>RTD #9</td><td>40</td><td>Mar Demand</td></tr> <tr><td>19</td><td>RTD #10</td><td>41</td><td>MW Demand</td></tr> <tr><td>20</td><td>RTD #11</td><td>42</td><td>MVD Demand</td></tr> <tr><td>21</td><td>RTD #12</td><td></td><td></td></tr> </tbody> </table>	VALUE	PARAMETER	VALUE	PARAMETER	0	None	22	AB Voltage	1	IA Output Current	23	BC Voltage	2	IB Output Current	24	CA Voltage	3	IC Output Current	25	Average Voltage	4	Avg. Output Current	26	Volts / Hertz	5	Neg. Seq. Current	27	Frequency	6	Averaged Gen. Load	28	Neutral Voltage (3rd)	7	Hottest Stator RTD	29	Power Factor	8	Hottest Bearing RTD	30	Reactive Power (Mvar)	9	Ambient RTD	31	Real Power (MW)	10	RTD #1	32	Apparent Power (MVA)	11	RTD #2	33	Analog Input 1	12	RTD #3	34	Analog Input 2	13	RTD #4	35	Analog Input 3	14	RTD #5	36	Analog Input 4	15	RTD #6	37	Tachometer	16	RTD #7	38	Therm. Capacity Used	17	RTD #8	39	Current Demand	18	RTD #9	40	Mar Demand	19	RTD #10	41	MW Demand	20	RTD #11	42	MVD Demand	21	RTD #12		
VALUE	PARAMETER	VALUE	PARAMETER																																																																																											
0	None	22	AB Voltage																																																																																											
1	IA Output Current	23	BC Voltage																																																																																											
2	IB Output Current	24	CA Voltage																																																																																											
3	IC Output Current	25	Average Voltage																																																																																											
4	Avg. Output Current	26	Volts / Hertz																																																																																											
5	Neg. Seq. Current	27	Frequency																																																																																											
6	Averaged Gen. Load	28	Neutral Voltage (3rd)																																																																																											
7	Hottest Stator RTD	29	Power Factor																																																																																											
8	Hottest Bearing RTD	30	Reactive Power (Mvar)																																																																																											
9	Ambient RTD	31	Real Power (MW)																																																																																											
10	RTD #1	32	Apparent Power (MVA)																																																																																											
11	RTD #2	33	Analog Input 1																																																																																											
12	RTD #3	34	Analog Input 2																																																																																											
13	RTD #4	35	Analog Input 3																																																																																											
14	RTD #5	36	Analog Input 4																																																																																											
15	RTD #6	37	Tachometer																																																																																											
16	RTD #7	38	Therm. Capacity Used																																																																																											
17	RTD #8	39	Current Demand																																																																																											
18	RTD #9	40	Mar Demand																																																																																											
19	RTD #10	41	MW Demand																																																																																											
20	RTD #11	42	MVD Demand																																																																																											
21	RTD #12																																																																																													
F128	Unsigned 16 bit integer	<p>Overcurrent curve style selection</p> <table border="1"> <thead> <tr> <th>VALUE</th> <th>PARAMETER</th> <th>VALUE</th> <th>PARAMETER</th> </tr> </thead> <tbody> <tr><td>0</td><td>ANSI Extremely Inverse</td><td>7</td><td>IEC Short Inverse</td></tr> <tr><td>1</td><td>ANSI Very Inverse</td><td>8</td><td>IAC Extremely Inverse</td></tr> <tr><td>2</td><td>ANSI Normally Inverse</td><td>9</td><td>IAC Very Inverse</td></tr> <tr><td>3</td><td>ANSI Moderately Inverse</td><td>10</td><td>IAC Inverse</td></tr> <tr><td>4</td><td>IEC Curve A (BS142)</td><td>11</td><td>IAC Short Inverse</td></tr> <tr><td>5</td><td>IEC Curve B (BS142)</td><td>12</td><td>Flexcurve™</td></tr> <tr><td>6</td><td>IEC Curve C (BS142)</td><td>13</td><td>Definite Time</td></tr> </tbody> </table>	VALUE	PARAMETER	VALUE	PARAMETER	0	ANSI Extremely Inverse	7	IEC Short Inverse	1	ANSI Very Inverse	8	IAC Extremely Inverse	2	ANSI Normally Inverse	9	IAC Very Inverse	3	ANSI Moderately Inverse	10	IAC Inverse	4	IEC Curve A (BS142)	11	IAC Short Inverse	5	IEC Curve B (BS142)	12	Flexcurve™	6	IEC Curve C (BS142)	13	Definite Time																																																												
VALUE	PARAMETER	VALUE	PARAMETER																																																																																											
0	ANSI Extremely Inverse	7	IEC Short Inverse																																																																																											
1	ANSI Very Inverse	8	IAC Extremely Inverse																																																																																											
2	ANSI Normally Inverse	9	IAC Very Inverse																																																																																											
3	ANSI Moderately Inverse	10	IAC Inverse																																																																																											
4	IEC Curve A (BS142)	11	IAC Short Inverse																																																																																											
5	IEC Curve B (BS142)	12	Flexcurve™																																																																																											
6	IEC Curve C (BS142)	13	Definite Time																																																																																											

Table 6–2: DATA FORMATS (Sheet 3 of 5)

FORMAT CODE	TYPE	DEFINITION																																																																																																																																																																																																																																																																																																
F129	Unsigned 16 bit integer	Analog input selection 0 = Disabled, 1 = 4-20 mA, 2 = 0-20 mA, 3 = 0-1 mA																																																																																																																																																																																																																																																																																																
F130	Unsigned 16 bit integer	Pickup type 0 = Over, 1 = Under																																																																																																																																																																																																																																																																																																
F131	Unsigned 16 bit integer	Input switch status 0 = Closed, 1 = Open																																																																																																																																																																																																																																																																																																
F132	Unsigned 16 bit integer	Trip coil supervision status 0 = No Coil, 1 = Coil																																																																																																																																																																																																																																																																																																
F133	Unsigned 16 bit integer	Generator status 0 = Offline, 1 = Offline, 2 = Online, 3 = Overload, 4 = Tripped																																																																																																																																																																																																																																																																																																
F134	Unsigned 16 bit integer	Cause of event / Cause of trip <table border="1" style="width: 100%; border-collapse: collapse;"> <thead> <tr> <th>VALUE</th> <th>PARAMETER</th> <th>VALUE</th> <th>PARAMETER</th> <th>VALUE</th> <th>PARAMETER</th> </tr> </thead> <tbody> <tr><td>0</td><td>No Event</td><td>47</td><td>Field-Bkr Discrep.</td><td>94</td><td>Analog I/P 3 Alarm</td></tr> <tr><td>1</td><td>General Sw. A Trip</td><td>48</td><td>Offline O/C Trip</td><td>95</td><td>Analog I/P 4 Alarm</td></tr> <tr><td>2</td><td>General Sw. B Trip</td><td>49</td><td>Phase O/C Trip</td><td>96</td><td>Reverse Power Alarm</td></tr> <tr><td>3</td><td>General Sw. C Trip</td><td>50</td><td>Neg. Seq. O/C Trip</td><td>97</td><td>Incomplete Seq.Alarm</td></tr> <tr><td>4</td><td>General Sw. D Trip</td><td>51</td><td>General Sw. A Alarm</td><td>98</td><td>Negative Seq. Alarm</td></tr> <tr><td>5</td><td>General Sw. E Trip</td><td>52</td><td>General Sw. B Alarm</td><td>99</td><td>Ground O/C Alarm</td></tr> <tr><td>6</td><td>General Sw. F Trip</td><td>53</td><td>General Sw. C Alarm</td><td>100</td><td></td></tr> <tr><td>7</td><td>General Sw. G Trip</td><td>54</td><td>General Sw. D Alarm</td><td>101</td><td>Service Alarm</td></tr> <tr><td>8</td><td>Sequential Trip</td><td>55</td><td>General Sw. E Alarm</td><td>102</td><td>Control Power Lost</td></tr> <tr><td>9</td><td>Tachometer Trip</td><td>56</td><td>General Sw. F Alarm</td><td>103</td><td>Cont. Power Applied</td></tr> <tr><td>10</td><td>UNKNOWN TRIP</td><td>57</td><td>General Sw. G Alarm</td><td>104</td><td>Thermal Reset Close</td></tr> <tr><td>11</td><td>UNKNOWN TRIP</td><td>58</td><td></td><td>105</td><td>Emergency Rst. Open</td></tr> <tr><td>12</td><td>Overload Trip</td><td>59</td><td>Tachometer Alarm</td><td>106</td><td>Start While Blocked</td></tr> <tr><td>13</td><td>UNKNOWN TRIP</td><td>60</td><td>Thermal Model Alarm</td><td>107</td><td>Relay Not Inserted</td></tr> <tr><td>14</td><td>Neutral O/V Trip</td><td>61</td><td>Overload Alarm</td><td>108</td><td>Trip Coil Super.</td></tr> <tr><td>15</td><td>Neut. U/V (3rd) Trip</td><td>62</td><td>Underfrequency Alarm</td><td>109</td><td>Breaker Failure</td></tr> <tr><td>16</td><td></td><td>63</td><td></td><td>110</td><td>VT Fuse Failure</td></tr> <tr><td>17</td><td></td><td>64</td><td>Ground Fault Alarm</td><td>111</td><td>Simulation Started</td></tr> <tr><td>18</td><td></td><td>65</td><td>RTD 1 Alarm</td><td>112</td><td>Simulation Stopped</td></tr> <tr><td>19</td><td></td><td>66</td><td>RTD 2 Alarm</td><td>113</td><td>Ground O/C Trip</td></tr> <tr><td>20</td><td>Differential Trip</td><td>67</td><td>RTD 3 Alarm</td><td>114</td><td>Volts/Hertz Trip</td></tr> <tr><td>21</td><td>Acceleration Trip</td><td>68</td><td>RTD 4 Alarm</td><td>115</td><td>Volts/Hertz Alarm</td></tr> <tr><td>22</td><td>RTD 1 Trip</td><td>69</td><td>RTD 5 Alarm</td><td>116</td><td>Low Fwd Power Trip</td></tr> <tr><td>23</td><td>RTD 2 Trip</td><td>70</td><td>RTD 6 Alarm</td><td>117</td><td>Inadvertent Energ.</td></tr> <tr><td>24</td><td>RTD 3 Trip</td><td>71</td><td>RTD 7 Alarm</td><td>118</td><td>Serial Start Command</td></tr> <tr><td>25</td><td>RTD 4 Trip</td><td>72</td><td>RTD 8 Alarm</td><td>119</td><td>Serial Stop Command</td></tr> <tr><td>26</td><td>RTD 5 Trip</td><td>73</td><td>RTD 9 Alarm</td><td>120</td><td>Input A Control</td></tr> <tr><td>27</td><td>RTD 6 Trip</td><td>74</td><td>RTD 10 Alarm</td><td>121</td><td>Input B Control</td></tr> <tr><td>28</td><td>RTD 7 Trip</td><td>75</td><td>RTD 11 Alarm</td><td>122</td><td>Input C Control</td></tr> <tr><td>29</td><td>RTD 8 Trip</td><td>76</td><td>RTD 12 Alarm</td><td>123</td><td>Input D Control</td></tr> <tr><td>30</td><td>RTD 9 Trip</td><td>77</td><td>Open RTD Alarm</td><td>124</td><td>Input E Control</td></tr> <tr><td>31</td><td>RTD 10 Trip</td><td>78</td><td>Short/Low RTD Alarm</td><td>125</td><td>Input F Control</td></tr> <tr><td>32</td><td>RTD 11 Trip</td><td>79</td><td>Undervoltage Alarm</td><td>126</td><td>Input G Control</td></tr> <tr><td>33</td><td>RTD 12 Trip</td><td>80</td><td>Overvoltage Alarm</td><td>127</td><td>Neutral O/V Alarm</td></tr> <tr><td>34</td><td>Undervoltage Trip</td><td>81</td><td>Overfrequency Alarm</td><td>128</td><td>Neut. U/V 3rd Alarm</td></tr> <tr><td>35</td><td>Overvoltage Trip</td><td>82</td><td>Power Factor Alarm</td><td>129</td><td>Setpoint 1 Active</td></tr> <tr><td>36</td><td>Phase Reversal Trip</td><td>83</td><td>Reactive Power Alarm</td><td>130</td><td>Setpoint 2 Active</td></tr> <tr><td>37</td><td>Overfrequency Trip</td><td>84</td><td>Low Fwd Power Alarm</td><td>131</td><td>Loss of Excitation 1</td></tr> <tr><td>38</td><td>Power Factor Trip</td><td>85</td><td>Trip Counter Alarm</td><td>132</td><td>Loss of Excitation 2</td></tr> <tr><td>39</td><td>Reactive Power Trip</td><td>86</td><td>Breaker Fail Alarm</td><td>133</td><td>Gnd. Directional Trip</td></tr> <tr><td>40</td><td>Underfrequency Trip</td><td>87</td><td>Current Demand Alarm</td><td>134</td><td>Gnd. Directional Alarm</td></tr> <tr><td>41</td><td>Analog I/P 1 Trip</td><td>88</td><td>kW Demand Alarm</td><td>135</td><td>HiSet Phase O/C Trip</td></tr> <tr><td>42</td><td>Analog I/P 2 Trip</td><td>89</td><td>kvar Demand Alarm</td><td>136</td><td>Distance Zone 1 Trip</td></tr> <tr><td>43</td><td>Analog I/P 3 Trip</td><td>90</td><td>kVA Demand Alarm</td><td>137</td><td>Distance Zone 2 Trip</td></tr> <tr><td>44</td><td>Analog I/P 4 Trip</td><td>91</td><td>Broken Rotor Bar</td><td>138</td><td>Dig I/P Wavefrm Trig</td></tr> <tr><td>45</td><td>Single Phasing Trip</td><td>92</td><td>Analog I/P 1 Alarm</td><td>139</td><td>Serial Waveform Trig</td></tr> <tr><td>46</td><td>Reverse Power Trip</td><td>93</td><td>Analog I/P 2 Alarm</td><td></td><td></td></tr> </tbody> </table>	VALUE	PARAMETER	VALUE	PARAMETER	VALUE	PARAMETER	0	No Event	47	Field-Bkr Discrep.	94	Analog I/P 3 Alarm	1	General Sw. A Trip	48	Offline O/C Trip	95	Analog I/P 4 Alarm	2	General Sw. B Trip	49	Phase O/C Trip	96	Reverse Power Alarm	3	General Sw. C Trip	50	Neg. Seq. O/C Trip	97	Incomplete Seq.Alarm	4	General Sw. D Trip	51	General Sw. A Alarm	98	Negative Seq. Alarm	5	General Sw. E Trip	52	General Sw. B Alarm	99	Ground O/C Alarm	6	General Sw. F Trip	53	General Sw. C Alarm	100		7	General Sw. G Trip	54	General Sw. D Alarm	101	Service Alarm	8	Sequential Trip	55	General Sw. E Alarm	102	Control Power Lost	9	Tachometer Trip	56	General Sw. F Alarm	103	Cont. Power Applied	10	UNKNOWN TRIP	57	General Sw. G Alarm	104	Thermal Reset Close	11	UNKNOWN TRIP	58		105	Emergency Rst. Open	12	Overload Trip	59	Tachometer Alarm	106	Start While Blocked	13	UNKNOWN TRIP	60	Thermal Model Alarm	107	Relay Not Inserted	14	Neutral O/V Trip	61	Overload Alarm	108	Trip Coil Super.	15	Neut. U/V (3rd) Trip	62	Underfrequency Alarm	109	Breaker Failure	16		63		110	VT Fuse Failure	17		64	Ground Fault Alarm	111	Simulation Started	18		65	RTD 1 Alarm	112	Simulation Stopped	19		66	RTD 2 Alarm	113	Ground O/C Trip	20	Differential Trip	67	RTD 3 Alarm	114	Volts/Hertz Trip	21	Acceleration Trip	68	RTD 4 Alarm	115	Volts/Hertz Alarm	22	RTD 1 Trip	69	RTD 5 Alarm	116	Low Fwd Power Trip	23	RTD 2 Trip	70	RTD 6 Alarm	117	Inadvertent Energ.	24	RTD 3 Trip	71	RTD 7 Alarm	118	Serial Start Command	25	RTD 4 Trip	72	RTD 8 Alarm	119	Serial Stop Command	26	RTD 5 Trip	73	RTD 9 Alarm	120	Input A Control	27	RTD 6 Trip	74	RTD 10 Alarm	121	Input B Control	28	RTD 7 Trip	75	RTD 11 Alarm	122	Input C Control	29	RTD 8 Trip	76	RTD 12 Alarm	123	Input D Control	30	RTD 9 Trip	77	Open RTD Alarm	124	Input E Control	31	RTD 10 Trip	78	Short/Low RTD Alarm	125	Input F Control	32	RTD 11 Trip	79	Undervoltage Alarm	126	Input G Control	33	RTD 12 Trip	80	Overvoltage Alarm	127	Neutral O/V Alarm	34	Undervoltage Trip	81	Overfrequency Alarm	128	Neut. U/V 3rd Alarm	35	Overvoltage Trip	82	Power Factor Alarm	129	Setpoint 1 Active	36	Phase Reversal Trip	83	Reactive Power Alarm	130	Setpoint 2 Active	37	Overfrequency Trip	84	Low Fwd Power Alarm	131	Loss of Excitation 1	38	Power Factor Trip	85	Trip Counter Alarm	132	Loss of Excitation 2	39	Reactive Power Trip	86	Breaker Fail Alarm	133	Gnd. Directional Trip	40	Underfrequency Trip	87	Current Demand Alarm	134	Gnd. Directional Alarm	41	Analog I/P 1 Trip	88	kW Demand Alarm	135	HiSet Phase O/C Trip	42	Analog I/P 2 Trip	89	kvar Demand Alarm	136	Distance Zone 1 Trip	43	Analog I/P 3 Trip	90	kVA Demand Alarm	137	Distance Zone 2 Trip	44	Analog I/P 4 Trip	91	Broken Rotor Bar	138	Dig I/P Wavefrm Trig	45	Single Phasing Trip	92	Analog I/P 1 Alarm	139	Serial Waveform Trig	46	Reverse Power Trip	93	Analog I/P 2 Alarm		
VALUE	PARAMETER	VALUE	PARAMETER	VALUE	PARAMETER																																																																																																																																																																																																																																																																																													
0	No Event	47	Field-Bkr Discrep.	94	Analog I/P 3 Alarm																																																																																																																																																																																																																																																																																													
1	General Sw. A Trip	48	Offline O/C Trip	95	Analog I/P 4 Alarm																																																																																																																																																																																																																																																																																													
2	General Sw. B Trip	49	Phase O/C Trip	96	Reverse Power Alarm																																																																																																																																																																																																																																																																																													
3	General Sw. C Trip	50	Neg. Seq. O/C Trip	97	Incomplete Seq.Alarm																																																																																																																																																																																																																																																																																													
4	General Sw. D Trip	51	General Sw. A Alarm	98	Negative Seq. Alarm																																																																																																																																																																																																																																																																																													
5	General Sw. E Trip	52	General Sw. B Alarm	99	Ground O/C Alarm																																																																																																																																																																																																																																																																																													
6	General Sw. F Trip	53	General Sw. C Alarm	100																																																																																																																																																																																																																																																																																														
7	General Sw. G Trip	54	General Sw. D Alarm	101	Service Alarm																																																																																																																																																																																																																																																																																													
8	Sequential Trip	55	General Sw. E Alarm	102	Control Power Lost																																																																																																																																																																																																																																																																																													
9	Tachometer Trip	56	General Sw. F Alarm	103	Cont. Power Applied																																																																																																																																																																																																																																																																																													
10	UNKNOWN TRIP	57	General Sw. G Alarm	104	Thermal Reset Close																																																																																																																																																																																																																																																																																													
11	UNKNOWN TRIP	58		105	Emergency Rst. Open																																																																																																																																																																																																																																																																																													
12	Overload Trip	59	Tachometer Alarm	106	Start While Blocked																																																																																																																																																																																																																																																																																													
13	UNKNOWN TRIP	60	Thermal Model Alarm	107	Relay Not Inserted																																																																																																																																																																																																																																																																																													
14	Neutral O/V Trip	61	Overload Alarm	108	Trip Coil Super.																																																																																																																																																																																																																																																																																													
15	Neut. U/V (3rd) Trip	62	Underfrequency Alarm	109	Breaker Failure																																																																																																																																																																																																																																																																																													
16		63		110	VT Fuse Failure																																																																																																																																																																																																																																																																																													
17		64	Ground Fault Alarm	111	Simulation Started																																																																																																																																																																																																																																																																																													
18		65	RTD 1 Alarm	112	Simulation Stopped																																																																																																																																																																																																																																																																																													
19		66	RTD 2 Alarm	113	Ground O/C Trip																																																																																																																																																																																																																																																																																													
20	Differential Trip	67	RTD 3 Alarm	114	Volts/Hertz Trip																																																																																																																																																																																																																																																																																													
21	Acceleration Trip	68	RTD 4 Alarm	115	Volts/Hertz Alarm																																																																																																																																																																																																																																																																																													
22	RTD 1 Trip	69	RTD 5 Alarm	116	Low Fwd Power Trip																																																																																																																																																																																																																																																																																													
23	RTD 2 Trip	70	RTD 6 Alarm	117	Inadvertent Energ.																																																																																																																																																																																																																																																																																													
24	RTD 3 Trip	71	RTD 7 Alarm	118	Serial Start Command																																																																																																																																																																																																																																																																																													
25	RTD 4 Trip	72	RTD 8 Alarm	119	Serial Stop Command																																																																																																																																																																																																																																																																																													
26	RTD 5 Trip	73	RTD 9 Alarm	120	Input A Control																																																																																																																																																																																																																																																																																													
27	RTD 6 Trip	74	RTD 10 Alarm	121	Input B Control																																																																																																																																																																																																																																																																																													
28	RTD 7 Trip	75	RTD 11 Alarm	122	Input C Control																																																																																																																																																																																																																																																																																													
29	RTD 8 Trip	76	RTD 12 Alarm	123	Input D Control																																																																																																																																																																																																																																																																																													
30	RTD 9 Trip	77	Open RTD Alarm	124	Input E Control																																																																																																																																																																																																																																																																																													
31	RTD 10 Trip	78	Short/Low RTD Alarm	125	Input F Control																																																																																																																																																																																																																																																																																													
32	RTD 11 Trip	79	Undervoltage Alarm	126	Input G Control																																																																																																																																																																																																																																																																																													
33	RTD 12 Trip	80	Overvoltage Alarm	127	Neutral O/V Alarm																																																																																																																																																																																																																																																																																													
34	Undervoltage Trip	81	Overfrequency Alarm	128	Neut. U/V 3rd Alarm																																																																																																																																																																																																																																																																																													
35	Overvoltage Trip	82	Power Factor Alarm	129	Setpoint 1 Active																																																																																																																																																																																																																																																																																													
36	Phase Reversal Trip	83	Reactive Power Alarm	130	Setpoint 2 Active																																																																																																																																																																																																																																																																																													
37	Overfrequency Trip	84	Low Fwd Power Alarm	131	Loss of Excitation 1																																																																																																																																																																																																																																																																																													
38	Power Factor Trip	85	Trip Counter Alarm	132	Loss of Excitation 2																																																																																																																																																																																																																																																																																													
39	Reactive Power Trip	86	Breaker Fail Alarm	133	Gnd. Directional Trip																																																																																																																																																																																																																																																																																													
40	Underfrequency Trip	87	Current Demand Alarm	134	Gnd. Directional Alarm																																																																																																																																																																																																																																																																																													
41	Analog I/P 1 Trip	88	kW Demand Alarm	135	HiSet Phase O/C Trip																																																																																																																																																																																																																																																																																													
42	Analog I/P 2 Trip	89	kvar Demand Alarm	136	Distance Zone 1 Trip																																																																																																																																																																																																																																																																																													
43	Analog I/P 3 Trip	90	kVA Demand Alarm	137	Distance Zone 2 Trip																																																																																																																																																																																																																																																																																													
44	Analog I/P 4 Trip	91	Broken Rotor Bar	138	Dig I/P Wavefrm Trig																																																																																																																																																																																																																																																																																													
45	Single Phasing Trip	92	Analog I/P 1 Alarm	139	Serial Waveform Trig																																																																																																																																																																																																																																																																																													
46	Reverse Power Trip	93	Analog I/P 2 Alarm																																																																																																																																																																																																																																																																																															

Table 6–2: DATA FORMATS (Sheet 4 of 5)

FORMAT CODE	TYPE	DEFINITION																																				
F136	16 bits	Order Code Bit 0: 0 = Code P5 (5A CT secondaries), 1 = Code P1 (1A CT secondaries) Bit 1: 0 = Code HI (High voltage power supply), 1 = Code LO (Low voltage power supply) Bit 2: 0 = Code A20 (4-20 mA analog outputs), 1 = Code A1 (0-1 mA analog outputs)																																				
F138	Unsigned 16 bit integer	Simulation mode 0 = Off, 1 = Simulate Pre-Fault, 2 = Simulate Fault, 3 = Pre-Fault to Fault																																				
F139	Unsigned 16 bit integer	Force operation of relays <table border="1" style="display: inline-table; margin-right: 20px;"> <thead> <tr> <th>VALUE</th> <th>PARAMETER</th> </tr> </thead> <tbody> <tr><td>0</td><td>Disabled</td></tr> <tr><td>1</td><td>R1 Trip</td></tr> <tr><td>2</td><td>R2 Auxiliary</td></tr> <tr><td>3</td><td>R3 Auxiliary</td></tr> <tr><td>4</td><td>R4 Auxiliary</td></tr> </tbody> </table> <table border="1" style="display: inline-table;"> <thead> <tr> <th>VALUE</th> <th>PARAMETER</th> </tr> </thead> <tbody> <tr><td>5</td><td>R5 Alarm</td></tr> <tr><td>6</td><td>R6 Service</td></tr> <tr><td>7</td><td>All Relays</td></tr> <tr><td>8</td><td>No Relays</td></tr> </tbody> </table>	VALUE	PARAMETER	0	Disabled	1	R1 Trip	2	R2 Auxiliary	3	R3 Auxiliary	4	R4 Auxiliary	VALUE	PARAMETER	5	R5 Alarm	6	R6 Service	7	All Relays	8	No Relays														
VALUE	PARAMETER																																					
0	Disabled																																					
1	R1 Trip																																					
2	R2 Auxiliary																																					
3	R3 Auxiliary																																					
4	R4 Auxiliary																																					
VALUE	PARAMETER																																					
5	R5 Alarm																																					
6	R6 Service																																					
7	All Relays																																					
8	No Relays																																					
F140	16 bits	General Status <table border="1" style="display: inline-table; margin-right: 20px;"> <thead> <tr> <th>BIT NO.</th> <th>PARAMETER</th> </tr> </thead> <tbody> <tr><td>Bit 0</td><td>Relay in Service</td></tr> <tr><td>Bit 1</td><td>Active Trip Condition</td></tr> <tr><td>Bit 2</td><td>Active Alarm Condition</td></tr> <tr><td>Bit 3</td><td>Reserved</td></tr> <tr><td>Bit 4</td><td>Reserved</td></tr> <tr><td>Bit 5</td><td>Reserved</td></tr> <tr><td>Bit 6</td><td>Reserved</td></tr> <tr><td>Bit 7</td><td>Simulation Mode Enabled</td></tr> </tbody> </table> <table border="1" style="display: inline-table;"> <thead> <tr> <th>BIT NO.</th> <th>PARAMETER</th> </tr> </thead> <tbody> <tr><td>Bit 8</td><td>Breaker Open LED</td></tr> <tr><td>Bit 9</td><td>Breaker Closed LED</td></tr> <tr><td>Bit 10</td><td>Hot Stator LED</td></tr> <tr><td>Bit 11</td><td>Neg. Sequence LED</td></tr> <tr><td>Bit 12</td><td>Ground LED</td></tr> <tr><td>Bit 13</td><td>Loss of Field LED</td></tr> <tr><td>Bit 14</td><td>VT Failure LED</td></tr> <tr><td>Bit 15</td><td>Breaker Failure LED</td></tr> </tbody> </table>	BIT NO.	PARAMETER	Bit 0	Relay in Service	Bit 1	Active Trip Condition	Bit 2	Active Alarm Condition	Bit 3	Reserved	Bit 4	Reserved	Bit 5	Reserved	Bit 6	Reserved	Bit 7	Simulation Mode Enabled	BIT NO.	PARAMETER	Bit 8	Breaker Open LED	Bit 9	Breaker Closed LED	Bit 10	Hot Stator LED	Bit 11	Neg. Sequence LED	Bit 12	Ground LED	Bit 13	Loss of Field LED	Bit 14	VT Failure LED	Bit 15	Breaker Failure LED
BIT NO.	PARAMETER																																					
Bit 0	Relay in Service																																					
Bit 1	Active Trip Condition																																					
Bit 2	Active Alarm Condition																																					
Bit 3	Reserved																																					
Bit 4	Reserved																																					
Bit 5	Reserved																																					
Bit 6	Reserved																																					
Bit 7	Simulation Mode Enabled																																					
BIT NO.	PARAMETER																																					
Bit 8	Breaker Open LED																																					
Bit 9	Breaker Closed LED																																					
Bit 10	Hot Stator LED																																					
Bit 11	Neg. Sequence LED																																					
Bit 12	Ground LED																																					
Bit 13	Loss of Field LED																																					
Bit 14	VT Failure LED																																					
Bit 15	Breaker Failure LED																																					
F141	16 bits	Output Relay Status <table border="1" style="display: inline-table; margin-right: 20px;"> <thead> <tr> <th>BIT NO.</th> <th>PARAMETER</th> </tr> </thead> <tbody> <tr><td>Bit 0</td><td>R1 Trip</td></tr> <tr><td>Bit 1</td><td>R2 Auxiliary</td></tr> <tr><td>Bit 2</td><td>R3 Auxiliary</td></tr> <tr><td>Bit 3</td><td>R4 Auxiliary</td></tr> <tr><td>Bit 4</td><td>R5 Alarm</td></tr> <tr><td>Bit 5</td><td>R6 Service</td></tr> <tr><td>Bit 6</td><td>Reserved</td></tr> <tr><td>Bit 7</td><td>Reserved</td></tr> </tbody> </table> <table border="1" style="display: inline-table;"> <thead> <tr> <th>BIT NO.</th> <th>PARAMETER</th> </tr> </thead> <tbody> <tr><td>Bit 8</td><td>Reserved</td></tr> <tr><td>Bit 9</td><td>Reserved</td></tr> <tr><td>Bit 10</td><td>Reserved</td></tr> <tr><td>Bit 11</td><td>Reserved</td></tr> <tr><td>Bit 12</td><td>Reserved</td></tr> <tr><td>Bit 13</td><td>Reserved</td></tr> <tr><td>Bit 14</td><td>Reserved</td></tr> <tr><td>Bit 15</td><td>Reserved</td></tr> </tbody> </table>	BIT NO.	PARAMETER	Bit 0	R1 Trip	Bit 1	R2 Auxiliary	Bit 2	R3 Auxiliary	Bit 3	R4 Auxiliary	Bit 4	R5 Alarm	Bit 5	R6 Service	Bit 6	Reserved	Bit 7	Reserved	BIT NO.	PARAMETER	Bit 8	Reserved	Bit 9	Reserved	Bit 10	Reserved	Bit 11	Reserved	Bit 12	Reserved	Bit 13	Reserved	Bit 14	Reserved	Bit 15	Reserved
BIT NO.	PARAMETER																																					
Bit 0	R1 Trip																																					
Bit 1	R2 Auxiliary																																					
Bit 2	R3 Auxiliary																																					
Bit 3	R4 Auxiliary																																					
Bit 4	R5 Alarm																																					
Bit 5	R6 Service																																					
Bit 6	Reserved																																					
Bit 7	Reserved																																					
BIT NO.	PARAMETER																																					
Bit 8	Reserved																																					
Bit 9	Reserved																																					
Bit 10	Reserved																																					
Bit 11	Reserved																																					
Bit 12	Reserved																																					
Bit 13	Reserved																																					
Bit 14	Reserved																																					
Bit 15	Reserved																																					
F142	Unsigned 16 bit integer	Thermal Model curve style selection 0 = Standard, 1 = Custom, 2 = Voltage Dependent																																				
F200	Unsigned 16 bit integer	Comm. monitor buffer status <table border="1" style="display: inline-table; margin-right: 20px;"> <thead> <tr> <th>VALUE</th> <th>PARAMETER</th> </tr> </thead> <tbody> <tr><td>0</td><td>Buffer Cleared</td></tr> <tr><td>1</td><td>Received OK</td></tr> <tr><td>2</td><td>Wrong Slave Addr.</td></tr> <tr><td>3</td><td>Illegal Function</td></tr> </tbody> </table> <table border="1" style="display: inline-table;"> <thead> <tr> <th>VALUE</th> <th>PARAMETER</th> </tr> </thead> <tbody> <tr><td>4</td><td>Illegal Count</td></tr> <tr><td>5</td><td>Illegal Reg. Addr.</td></tr> <tr><td>6</td><td>CRC Error</td></tr> <tr><td>7</td><td>Illegal Data</td></tr> </tbody> </table>	VALUE	PARAMETER	0	Buffer Cleared	1	Received OK	2	Wrong Slave Addr.	3	Illegal Function	VALUE	PARAMETER	4	Illegal Count	5	Illegal Reg. Addr.	6	CRC Error	7	Illegal Data																
VALUE	PARAMETER																																					
0	Buffer Cleared																																					
1	Received OK																																					
2	Wrong Slave Addr.																																					
3	Illegal Function																																					
VALUE	PARAMETER																																					
4	Illegal Count																																					
5	Illegal Reg. Addr.																																					
6	CRC Error																																					
7	Illegal Data																																					
F201	Unsigned 16 bit integer	Curve Reset Type 0 = Instantaneous, 1 = Linear																																				
F202	Unsigned 16 bit integer	Inadvertent energization arming type 0 = U/V and Offline, 1 = U/V or Offline																																				
F206	Unsigned 16 bit integer	Sequential trip type 0 = Low Forward Power, 1 = Reverse Power																																				
F207	Unsigned 16 bit integer	Switch status 0 = Open, 1 = Shorted																																				
F208	Unsigned 16 bit integer	Undervoltage trip element type 0 = Curve, 1 = Definite Time																																				
F209	Unsigned 16 bit integer	Breaker operation type 0 = Breaker Auxiliary a, 1 = Breaker Auxiliary b																																				

Table 6–2: DATA FORMATS (Sheet 5 of 5)

FORMAT CODE	TYPE	DEFINITION																																
F210	Unsigned 16 bit integer	Assignable input selection <table border="1"> <thead> <tr> <th>VALUE</th> <th>PARAMETER</th> <th>VALUE</th> <th>PARAMETER</th> </tr> </thead> <tbody> <tr> <td>0</td> <td>None</td> <td>4</td> <td>Input 4</td> </tr> <tr> <td>1</td> <td>Input 1</td> <td>5</td> <td>Input 5</td> </tr> <tr> <td>2</td> <td>Input 2</td> <td>6</td> <td>Input 6</td> </tr> <tr> <td>3</td> <td>Input 3</td> <td>7</td> <td>Input 7</td> </tr> </tbody> </table>	VALUE	PARAMETER	VALUE	PARAMETER	0	None	4	Input 4	1	Input 1	5	Input 5	2	Input 2	6	Input 6	3	Input 3	7	Input 7												
VALUE	PARAMETER	VALUE	PARAMETER																															
0	None	4	Input 4																															
1	Input 1	5	Input 5																															
2	Input 2	6	Input 6																															
3	Input 3	7	Input 7																															
F211	Unsigned 16 bit integer	Volts/Hertz element type 0 = Curve #1, 1 = Curve #2, 2 = Curve #2, 3 = Definite Time																																
F212	Unsigned 16 bit integer	RTD number <table border="1"> <thead> <tr> <th>VALUE</th> <th>PARAMETER</th> <th>VALUE</th> <th>PARAMETER</th> </tr> </thead> <tbody> <tr> <td>0</td> <td>All</td> <td>7</td> <td>RTD #7</td> </tr> <tr> <td>1</td> <td>RTD #1</td> <td>8</td> <td>RTD #8</td> </tr> <tr> <td>2</td> <td>RTD #2</td> <td>9</td> <td>RTD #9</td> </tr> <tr> <td>3</td> <td>RTD #3</td> <td>10</td> <td>RTD #10</td> </tr> <tr> <td>4</td> <td>RTD #4</td> <td>11</td> <td>RTD #11</td> </tr> <tr> <td>5</td> <td>RTD #5</td> <td>12</td> <td>RTD #12</td> </tr> <tr> <td>6</td> <td>RTD #6</td> <td></td> <td></td> </tr> </tbody> </table>	VALUE	PARAMETER	VALUE	PARAMETER	0	All	7	RTD #7	1	RTD #1	8	RTD #8	2	RTD #2	9	RTD #9	3	RTD #3	10	RTD #10	4	RTD #4	11	RTD #11	5	RTD #5	12	RTD #12	6	RTD #6		
VALUE	PARAMETER	VALUE	PARAMETER																															
0	All	7	RTD #7																															
1	RTD #1	8	RTD #8																															
2	RTD #2	9	RTD #9																															
3	RTD #3	10	RTD #10																															
4	RTD #4	11	RTD #11																															
5	RTD #5	12	RTD #12																															
6	RTD #6																																	
F213	Unsigned 16 bit integer	Communications monitor port selection 0 = Computer RS485, 1 = Auxiliary RS485, 2 = Front Panel RS232																																
F214	Unsigned 16 bit integer	Waveform Memory Channel Selector <table border="1"> <thead> <tr> <th>VALUE</th> <th>PARAMETER</th> <th>VALUE</th> <th>PARAMETER</th> </tr> </thead> <tbody> <tr> <td>0</td> <td>Phase A line current 512 counts = 1 × CT</td> <td>5</td> <td>Neutral-end phase C line current 512 counts = 1 × CT</td> </tr> <tr> <td>1</td> <td>Phase B line current 512 counts = 1 × CT</td> <td>6</td> <td>Ground current 512 counts = 1 × CT</td> </tr> <tr> <td>2</td> <td>Phase C line current 512 counts = 1 × CT</td> <td>7</td> <td>Phase A to neutral voltage 3500 counts = 120 secondary volts</td> </tr> <tr> <td>3</td> <td>Neutral-end phase A line current 512 counts = 1 × CT</td> <td>8</td> <td>Phase B to neutral voltage 3500 counts = 120 secondary volts</td> </tr> <tr> <td>4</td> <td>Neutral-end phase B line current 512 counts equals 1 × CT</td> <td>9</td> <td>Phase C to neutral voltage 3500 counts = 120 secondary volts</td> </tr> </tbody> </table>	VALUE	PARAMETER	VALUE	PARAMETER	0	Phase A line current 512 counts = 1 × CT	5	Neutral-end phase C line current 512 counts = 1 × CT	1	Phase B line current 512 counts = 1 × CT	6	Ground current 512 counts = 1 × CT	2	Phase C line current 512 counts = 1 × CT	7	Phase A to neutral voltage 3500 counts = 120 secondary volts	3	Neutral-end phase A line current 512 counts = 1 × CT	8	Phase B to neutral voltage 3500 counts = 120 secondary volts	4	Neutral-end phase B line current 512 counts equals 1 × CT	9	Phase C to neutral voltage 3500 counts = 120 secondary volts								
VALUE	PARAMETER	VALUE	PARAMETER																															
0	Phase A line current 512 counts = 1 × CT	5	Neutral-end phase C line current 512 counts = 1 × CT																															
1	Phase B line current 512 counts = 1 × CT	6	Ground current 512 counts = 1 × CT																															
2	Phase C line current 512 counts = 1 × CT	7	Phase A to neutral voltage 3500 counts = 120 secondary volts																															
3	Neutral-end phase A line current 512 counts = 1 × CT	8	Phase B to neutral voltage 3500 counts = 120 secondary volts																															
4	Neutral-end phase B line current 512 counts equals 1 × CT	9	Phase C to neutral voltage 3500 counts = 120 secondary volts																															
F215	Unsigned 16 bit integer	Current Source 0 = Neutral-end CTs; 1 = Output-end CTs																																
F216	Unsigned 16 bit integer	DNP Port Selection 0 = None, 1 = Computer RS485, 2 = Auxiliary RS485, 3 = Front Panel RS485																																
F217	Unsigned 16 bit integer	Ground Directional MTA 0 = 0°, 1 = 90°, 2 = 180°, 3 = 270°																																
F218	Unsigned 16 bit integer	Breaker State 0 = 52 Closed, 1 = 52 Open/Closed																																
F219	Unsigned 16 bit integer	Step Up Transformer Type 0 = None, 1 = Delta/Wye																																
F220	Unsigned 16 bit integer	IRIG-B Type 0 = None, 1 = DC Shift, 2 = Amplitude Modulated																																

6.4.1 DEVICE PROFILE DOCUMENT

DNP 3.0 DEVICE PROFILE DOCUMENT	
Vendor Name: General Electric Power Management Inc.	
Device Name: 489 Generator Management Relay	
Highest DNP Level Supported: For Requests: Level 2 For Responses: Level 2	Device Function: <input type="checkbox"/> Master <input checked="" type="checkbox"/> Slave
Notable objects, functions, and/or qualifiers supported in addition to the Highest DNP Levels Supported (the complete list is described in the attached table): Binary Input (Object 1, Variations 1 and 2) Binary Output (Object 10, Variation 2) Binary Counter (Object 20, Variations 5 and 6) Frozen Counter (Object 21, Variations 9 and 10) Analog Input (Object 30, Variations 1, 2, 3, and 4) Analog Input Change (Object 32, Variations 1, 2, 3, and 4) Warm Restart (Function code 14)	
Maximum Data Link Frame Size (octets): Transmitted: 292 Received: 292	Maximum Application Fragment Size (octets): Transmitted: 2048 Received: 2048
Maximum Data Link Re-tries: <input checked="" type="checkbox"/> None <input type="checkbox"/> Fixed <input type="checkbox"/> Configurable	Maximum Application Layer Re-tries: <input checked="" type="checkbox"/> None <input type="checkbox"/> Configurable
Requires Data Link Layer Confirmation: <input checked="" type="checkbox"/> Never <input type="checkbox"/> Always <input type="checkbox"/> Sometimes <input type="checkbox"/> Configurable	Requires Application Layer Confirmation: <input type="checkbox"/> Never <input type="checkbox"/> Always <input checked="" type="checkbox"/> When reporting Event Data <input type="checkbox"/> When sending multi-fragment responses <input type="checkbox"/> Sometimes <input type="checkbox"/> Configurable
Timeouts while waiting for:	
Data Link Confirm	<input checked="" type="checkbox"/> None <input type="checkbox"/> Fixed <input type="checkbox"/> Variable <input type="checkbox"/> Configurable
Complete Appl. Fragment	<input checked="" type="checkbox"/> None <input type="checkbox"/> Fixed <input type="checkbox"/> Variable <input type="checkbox"/> Configurable
Application Confirm	<input checked="" type="checkbox"/> None <input type="checkbox"/> Fixed <input type="checkbox"/> Variable <input type="checkbox"/> Configurable
Complete Appl. Response	<input checked="" type="checkbox"/> None <input type="checkbox"/> Fixed <input type="checkbox"/> Variable <input type="checkbox"/> Configurable
Others:	(None)
Executes Control Operations:	
WRITE Binary Outputs	<input checked="" type="checkbox"/> Never <input type="checkbox"/> Always <input type="checkbox"/> Sometimes <input type="checkbox"/> Configurable
SELECT/OPERATE	<input checked="" type="checkbox"/> Never <input type="checkbox"/> Always <input type="checkbox"/> Sometimes <input type="checkbox"/> Configurable
DIRECT OPERATE	<input type="checkbox"/> Never <input checked="" type="checkbox"/> Always <input type="checkbox"/> Sometimes <input type="checkbox"/> Configurable
DIRECT OPERATE - NO ACK	<input type="checkbox"/> Never <input checked="" type="checkbox"/> Always <input type="checkbox"/> Sometimes <input type="checkbox"/> Configurable
Count > 1	<input checked="" type="checkbox"/> Never <input type="checkbox"/> Always <input type="checkbox"/> Sometimes <input type="checkbox"/> Configurable
Pulse On	<input type="checkbox"/> Never <input checked="" type="checkbox"/> Always <input type="checkbox"/> Sometimes <input type="checkbox"/> Configurable
Pulse Off	<input checked="" type="checkbox"/> Never <input type="checkbox"/> Always <input type="checkbox"/> Sometimes <input type="checkbox"/> Configurable
Latch On	<input checked="" type="checkbox"/> Never <input type="checkbox"/> Always <input type="checkbox"/> Sometimes <input type="checkbox"/> Configurable
Latch Off	<input checked="" type="checkbox"/> Never <input type="checkbox"/> Always <input type="checkbox"/> Sometimes <input type="checkbox"/> Configurable
(For an explanation of the above, refer to the discussion accompanying the point list for the Binary Output/Control Relay Output Block objects)	
Queue	<input checked="" type="checkbox"/> Never <input type="checkbox"/> Always <input type="checkbox"/> Sometimes <input type="checkbox"/> Configurable
Clear Queue	<input checked="" type="checkbox"/> Never <input type="checkbox"/> Always <input type="checkbox"/> Sometimes <input type="checkbox"/> Configurable

DNP 3.0 DEVICE PROFILE DOCUMENT (CONTINUED)	
Reports Binary Input Change Events when no specific variations requested: <input type="checkbox"/> Never <input checked="" type="checkbox"/> Only time-tagged <input type="checkbox"/> Only non-time-tagged <input type="checkbox"/> Configurable to send both, one or the other	Reports time-tagged Binary Input Change Events when no specific variation requested: <input type="checkbox"/> Never <input checked="" type="checkbox"/> Binary Input Change With Time <input type="checkbox"/> Binary Input Change With Relative Time <input type="checkbox"/> Configurable
Sends Unsolicited Responses: <input checked="" type="checkbox"/> Never <input type="checkbox"/> Configurable <input type="checkbox"/> Only certain objects <input type="checkbox"/> Sometimes <input type="checkbox"/> ENABLE/DISABLE UNSOLICITED Function codes supported	Sends Static Data in Unsolicited Responses: <input checked="" type="checkbox"/> Never <input type="checkbox"/> When Device Restarts <input type="checkbox"/> When Status Flags Change
Default Counter Object/Variation: <input type="checkbox"/> No Counters Reported <input type="checkbox"/> Configurable <input checked="" type="checkbox"/> Default Object Default Variation <input type="checkbox"/> Point-by-point list attached	Counters Roll Over at: <input type="checkbox"/> No Counters Reported <input type="checkbox"/> Configurable <input type="checkbox"/> 16 Bits <input type="checkbox"/> 32 Bits <input type="checkbox"/> Other Value <input checked="" type="checkbox"/> Point-by-point list attached
Sends Multi-Fragment Responses: p Yes <input checked="" type="checkbox"/> No	

6.4.2 IMPLEMENTATION TABLE

The table below gives a list of all objects recognized and returned by the relay. Additional information is provided on the following pages including a list of the default variations returned for each object and lists of defined point numbers for each object.

Table 6–3: IMPLEMENTATION TABLE

OBJECT		DESCRIPTION	REQUEST		RESPONSE	
OBJ	VAR		FUNC. CODES	QUAL. CODES (HEX)	FUNC. CODES	QUAL. CODES (HEX)
1	0	Binary Input - All Variations	1	06		
1	1	Binary Input	1	00, 01, 06	129	00, 01
1	2	Binary Input With Status	1	00, 01, 06	129	00, 01
2	0	Binary Input Change - All Variations	1	06, 07, 08		
2	1	Binary Input Change Without Time	1	06, 07, 08	129	17, 28
2	2	Binary Input Change With Time	1	06, 07, 08	129	17, 28
10	0	Binary Output - All Variations	1	06		
10	2	Binary Output Status	1	00, 01, 06	129	00, 01
12	1	Control Relay Output Block	5, 6	17, 28	129	17, 28
20	0	Binary Counter - All Variations	1,7,8,9,10	06	129	00, 01
20	5	32-Bit Binary Counter without Flag	1,7,8,9,10	06	129	00, 01
20	6	16-Bit Binary Counter without Flag	1,7,8,9,10	06	129	00, 01
21	0	Frozen Counter - All Variations	1	06	129	00, 01
21	9	32-Bit Frozen Counter without Flag	1	06	129	00, 01
21	10	16-Bit Frozen Counter without Flag	1	06	129	00, 01
30	0	Analog Input - All Variations	1	06		
30	1	32-Bit Analog Input With Flag	1	00, 01, 06	129	00, 01
30	2	16-Bit Analog Input With Flag	1	00, 01, 06	129	00, 01
30	3	32-Bit Analog Input Without Flag	1	00, 01, 06	129	00, 01
30	4	16-Bit Analog Input Without Flag	1	00, 01, 06	129	00, 01
32	0	Analog Input Change - All Variations	1	06, 07, 08		
32	1	32-Bit Analog Input Change Without Time	1	06, 07, 08	129	17, 28
32	2	16-Bit Analog Input Change Without Time	1	06, 07, 08	129	17, 28
32	3	32-Bit Analog Input Change With Time	1	06, 07, 08	129	17, 28
32	4	16-Bit Analog Input Change With Time	1	06, 07, 08	129	17, 28
50	1	Time and Date	1, 2	07 (Note 1)	129	07
60	1	Class 0 Data (Note 2)	1	06	129	
60	2	Class 1 Data (Note 3)	1	06, 07, 08	129	
60	3	Class 2 Data (Note 3)	1	06, 07, 08	129	
60	4	Class 3 Data (Note 3)	1	06, 07, 08	129	
80	1	Internal Indications	2	00 (Note 4)	129	
		No object (cold restart command)	13			
		No object (warm restart command)	14			
		No object (delay measurement command) (Note 5)	23			

For Notes, see the IMPLEMENTATION TABLE NOTES on the following page.

IMPLEMENTATION TABLE NOTES:

1. For this object, the quantity specified in the request must be exactly 1 as there is only one instance of this object defined in the relay.
2. All static data known to the relay is returned in response to a request for Class 0. This includes all objects of type 1 (Binary Input), type 10 (Binary Output), type 20 (Binary Counter), type 21 (Frozen Counter) and type 30 (Analog Input).
3. The point tables for Binary Input and Analog Input objects contain a field that defines to which event class the corresponding static data point has been assigned.
4. For this object, the qualifier code must specify an index of 7 only.
5. Delay Measurement (function code 23) is supported since the relay allows for writing the time via object 50 and it also periodically sets the "Time Synchronization Required" Internal Indication (IIN). The IIN is set at power-up and will be set again 24 hours after it was last cleared. The IIN is cleared when time is written as object 50 data or if IRIG-B is enabled and relay time is updated as a result of a successful decoding of this signal.

6.4.3 DEFAULT VARIATIONS

The following table specifies the default variation for all objects returned by the relay. These are the variations that will be returned for the object in a response when no specific variation is specified in a request.

Table 6–4: DEFAULT VARIATIONS

OBJECT	DESCRIPTION	DEFAULT VARIATION
1	Binary Input - Single Bit	1
2	Binary Input Change With Time	2
10	Binary Output Status	2
20	16-Bit Binary Counter without Flag	6
21	16-Bit Frozen Counter without Flag	10
30	32-Bit Analog Input Without Flag	3
32	32-Bit Analog Input Change Without Time	1

6.5.1 BINARY INPUT / BINARY INPUT CHANGE (OBJECTS 01/02)

POINT LIST FOR: BINARY INPUT (OBJECT 01) BINARY INPUT CHANGE (OBJECT 02) (SHEET 1 OF 4)		
INDEX	DESCRIPTION	EVENT CLASS ASSIGNED
0	Relay In Service	Class 1
1	Trip Condition Active	Class 1
2	Alarm Condition Active	Class 1
3	Simulation Mode Enabled	Class 1
4	Breaker Is Open	Class 1
5	Breaker Is Closed	Class 1
6	Hot Stator Fault Active	Class 1
7	Negative Sequence Fault Active	Class 1
8	Ground Fault Active	Class 1
9	Loss Of Field Fault Active	Class 1
10	VT Failure Detected	Class 1
11	Breaker Failure Detected	Class 1
12	Relay 1 Trip Operated	Class 1
13	Relay 2 Auxiliary Operated	Class 1
14	Relay 3 Auxiliary Operated	Class 1
15	Relay 4 Auxiliary Operated	Class 1
16	Relay 5 Alarm Operated	Class 1
17	Relay 6 Service Operated	Class 1
18	Setpoint Access Input Closed	Class 1
19	Breaker Status Input Closed	Class 1
20	Assignable Input 1 Closed	Class 1
21	Assignable Input 2 Closed	Class 1
22	Assignable Input 3 Closed	Class 1
23	Assignable Input 4 Closed	Class 1
24	Assignable Input 5 Closed	Class 1
25	Assignable Input 6 Closed	Class 1
26	Assignable Input 7 Closed	Class 1
27	Trip Coil Supervision - Coil Detected	Class 1
28	... Reserved ...	
↓	↓	↓
39	... Reserved ...	
40	Assignable Input 1 Trip Active / Latched	Class 1
41	Assignable Input 2 Trip Active / Latched	Class 1
42	Assignable Input 3 Trip Active / Latched	Class 1
43	Assignable Input 4 Trip Active / Latched	Class 1
44	Assignable Input 5 Trip Active / Latched	Class 1
45	Assignable Input 6 Trip Active / Latched	Class 1
46	Assignable Input 7 Trip Active / Latched	Class 1
47	Sequential Trip Active or Latched	Class 1

POINT LIST FOR: BINARY INPUT (OBJECT 01) BINARY INPUT CHANGE (OBJECT 02) (SHEET 2 OF 4)		
INDEX	DESCRIPTION	EVENT CLASS ASSIGNED
48	Field-Breaker Discrepancy Trip Active or Latched	Class 1
49	Tachometer Trip Active or Latched	Class 1
50	Offline O/C Trip Active or Latched	Class 1
51	Inadvertent Energization Trip Active or Latched	Class 1
52	Phase O/C Trip Active or Latched	Class 1
53	Neg. Seq. O/C Trip Active or Latched	Class 1
54	Ground O/C Trip Active or Latched	Class 1
55	Phase Differential Trip Active or Latched	Class 1
56	Undervoltage Trip Active or Latched	Class 1
57	Overvoltage Trip Active or Latched	Class 1
58	Volts/Hertz Trip Active or Latched	Class 1
59	Phase Reversal Trip Active or Latched	Class 1
60	Underfrequency Trip Active or Latched	Class 1
61	Overfrequency Trip Active or Latched	Class 1
62	Neutral O/V (Fund) Trip Active / Latched	Class 1
63	Neutral U/V (3 rd Harmonic) Trip Active or Latched	Class 1
64	Reactive Power Trip Active or Latched	Class 1
65	Reverse Power Trip Active or Latched	Class 1
66	Low Fwd Power Trip Active or Latched	Class 1
67	Thermal Model Trip Active or Latched	Class 1
68	RTD #1 Trip Active or Latched	Class 1
69	RTD #2 Trip Active or Latched	Class 1
70	RTD #3 Trip Active or Latched	Class 1
71	RTD #4 Trip Active or Latched	Class 1
72	RTD #5 Trip Active or Latched	Class 1
73	RTD #6 Trip Active or Latched	Class 1
74	RTD #7 Trip Active or Latched	Class 1
75	RTD #8 Trip Active or Latched	Class 1
76	RTD #9 Trip Active or Latched	Class 1
77	RTD #10 Trip Active or Latched	Class 1
78	RTD #11 Trip Active or Latched	Class 1
79	RTD #12 Trip Active or Latched	Class 1
80	Analog Input 1 Trip Active or Latched	Class 1
81	Analog Input 2 Trip Active or Latched	Class 1
82	Analog Input 3 Trip Active or Latched	Class 1
83	Analog Input 4 Trip Active or Latched	Class 1
84	Loss of Excitation Circle 1 Trip Active or Latched	Class 1
85	Loss of Excitation Circle 2 Trip Active or Latched	Class 1

POINT LIST FOR: BINARY INPUT (OBJECT 01) BINARY INPUT CHANGE (OBJECT 02) (SHEET 3 OF 4)		
INDEX	DESCRIPTION	EVENT CLASS ASSIGNED
86	Ground Directional Trip Active or Latched	Class 1
87	High Set Phase O/C Trip Active or Latched	Class 1
88	Distance Zone 1 Trip Active or Latched	Class 1
89	Distance Zone 2 Trip Active or Latched	Class 1
90	... Reserved ...	
↓	↓	↓
99	... Reserved ...	
100	Assignable In 1 Alarm Active / Latched	Class 1
101	Assignable In 2 Alarm Active or Latched	Class 1
102	Assignable In 3 Alarm Active or Latched	Class 1
103	Assignable In 4 Alarm Active or Latched	Class 1
104	Assignable In 5 Alarm Active or Latched	Class 1
105	Assignable In 6 Alarm Active or Latched	Class 1
106	Assignable In 7 Alarm Active / Latched	Class 1
107	Tachometer Alarm Active or Latched	Class 1
108	Overcurrent Alarm Active or Latched	Class 1
109	Neg Seq Alarm Active or Latched	Class 1
110	Ground O/C Alarm Active or Latched	Class 1
111	Undervoltage Alarm Active or Latched	Class 1
112	Overvoltage Alarm Active or Latched	Class 1
113	Volts/Hertz Alarm Active or Latched	Class 1
114	Underfreq Alarm Active or Latched	Class 1
115	Overfrequency Alarm Active or Latched	Class 1
116	Neutral O/V (fundamental) Alarm Active or Latched	Class 1
117	Neutral U/V (3 rd harm) Alarm Active or Latched	Class 1
118	Reactive Power Alarm Active or Latched	Class 1
119	Reverse Power Alarm Active or Latched	Class 1
120	Low Fwd Power Alarm Active / Latched	Class 1
121	RTD #1 Alarm Active or Latched	Class 1
122	RTD #2 Alarm Active or Latched	Class 1
123	RTD #3 Alarm Active or Latched	Class 1
124	RTD #4 Alarm Active or Latched	Class 1
125	RTD #5 Alarm Active or Latched	Class 1
126	RTD #6 Alarm Active or Latched	Class 1

POINT LIST FOR: BINARY INPUT (OBJECT 01) BINARY INPUT CHANGE (OBJECT 02) (SHEET 4 OF 4)		
INDEX	DESCRIPTION	EVENT CLASS ASSIGNED
127	RTD #7 Alarm Active or Latched	Class 1
128	RTD #8 Alarm Active or Latched	Class 1
129	RTD #9 Alarm Active or Latched	Class 1
130	RTD #10 Alarm Active or Latched	Class 1
131	RTD #11 Alarm Active or Latched	Class 1
132	RTD #12 Alarm Active or Latched	Class 1
133	Open Sensor Alarm Active or Latched	Class 1
134	Short/Low Temp Alarm Active / Latched	Class 1
135	Thermal Model Alarm Active or Latched	Class 1
136	Trip Counter Alarm Active or Latched	Class 1
137	Breaker Failure Alarm Active or Latched	Class 1
138	Trip Coil Monitor Alarm Active / Latched	Class 1
139	VTFE Alarm Active or Latched	Class 1
140	Current Dmd Alarm Active or Latched	Class 1
141	MW Demand Alarm Active or Latched	Class 1
142	Mar Demand Alarm Active or Latched	Class 1
143	MVA Alarm Active or Latched	Class 1
144	Analog Input 1 Alarm Active or Latched	Class 1
145	Analog Input 2 Alarm Active or Latched	Class 1
146	Analog Input 3 Alarm Active or Latched	Class 1
147	Analog Input 4 Alarm Active or Latched	Class 1
148	Not Programmed Alarm Active / Latched	Class 1
149	Simulation Mode Alarm Active or Latched	Class 1
150	Output Relays Forced Alarm Active or Latched	Class 1
151	Analog Output Forced Alarm Active or Latched	Class 1
152	Test Switch Shorted Alarm Active or Latched	Class 1
153	Gnd Directional Alarm Active or Latched	Class 1
154	IRIG-B Failure Alarm Active or Latched	Class 1
155	Generator Running Hour Alarm Active or Latched	Class 1



Any detected change in the state of any point assigned to Class 1 will cause the generation of an event object.

6.5.2 BINARY / CONTROL RELAY OUTPUT BLOCK (OBJECTS 10/12)

POINT LIST FOR: BINARY OUTPUT (OBJECT 10) CONTROL RELAY OUTPUT BLOCK (OBJECT 12)	
INDEX	DESCRIPTION
0	Reset
1	Generator Start
2	Generator Stop
3	Clear Trip Counters
4	Clear Last Trip Data
5	Clear MWh and Mvarh
6	Clear Peak Demand Data
7	Clear Generator Information
8	Clear Breaker Information

The following restrictions should be noted when using object 12 to control the points listed in the above table.

1. The **Count** field is checked first. If it is zero, the command will be accepted but no action will be taken. If this field is non-zero, the command will be executed exactly once regardless of its value.
2. The **Control Code** field of object 12 is then inspected:
 - The Queue and Clear sub-fields are ignored.
 - If the **Control Code** field is zero (i.e., NUL operation) the command is accepted but no action is taken.
 - For all points, the only valid control is "Close - Pulse On" (41 hex). This is used to initiate the function (e.g., Reset) associated with the point.
 - Any value in the **Control Code** field not specified above is invalid and will be rejected.
3. The **On Time** and **Off Time** fields are ignored. A "Pulse On" control takes effect immediately when received. Thus, the timing is irrelevant.
4. The **Status** field in the response will reflect the success or failure of the control attempt thus:
 - A Status of "Request Accepted" (0) will be returned if the command was accepted.
 - A Status of "Request not Accepted due to Formatting Errors" (3) will be returned if the **Control Code** field was incorrectly formatted or an invalid Code was present in the command.
 - A Status of "Control Operation not Supported for this Point" (4) will be returned if an attempt was made to operate the point and the relay, owing to its configuration, does not allow the point to perform its function.

An operate of the Reset point may fail (even if the command is accepted) due to other inputs or conditions (e.g., blocks) existing at the time. To verify the success or failure of an operate of this point it is necessary that the associated Binary Input(s) be examined after the control attempt is performed.

When using object 10 to read the status of any Binary Output, a value of zero will always be returned. This is due to the fact that all points are "Pulse On" and are deemed to be normally off.

6.5.3 BINARY / FROZEN COUNTER (OBJECTS 20/21)

POINT LIST FOR: BINARY COUNTER (OBJECT 20) FROZEN COUNTER (OBJECT 21)		
INDEX	ROLLOVER POINT	DESCRIPTION
0	50,000	Number of Breaker Operations
1	50,000	Number of Thermal Resets
2	50,000	Number of Trips (total)
3	50,000	Number of Digital Input Trips
4	50,000	Number of Sequential Trips
5	50,000	Number of Field-Breaker Discrepancy Trips
6	50,000	Number of Tachometer Trips
7	50,000	Number of Offline Overcurrent Trips
8	50,000	Number of Phase Overcurrent Trips
9	50,000	Number of Negative Sequence Overcurrent Trips
10	50,000	Number of Ground Overcurrent Trips
11	50,000	Number of Phase Differential Trips
12	50,000	Number of Undervoltage Trips
13	50,000	Number of Overvoltage Trips
14	50,000	Number of Volts/Hertz Trips
15	50,000	Number of Phase Reversal Trips
16	50,000	Number of Underfrequency Trips
17	50,000	Number of Overfrequency Trips
18	50,000	Number of Neutral Overvoltage (Fundamental) Trips
19	50,000	Number of Neutral Undervoltage (3 rd Harmonic) Trips
20	50,000	Number of Reactive Power Trips
21	50,000	Number of Reverse Power Trips
22	50,000	Number of Underpower Trips
23	50,000	Number of Stator RTD Trips
24	50,000	Number of Bearing RTD Trips
25	50,000	Number of Other RTD Trips
26	50,000	Number of Ambient RTD Trips
27	50,000	Number of Thermal Model Trips
28	50,000	Number of Inadvertent Energization Trips
29	50,000	Number of Analog Input 1 Trips
30	50,000	Number of Analog Input 2 Trips
31	50,000	Number of Analog Input 3 Trips
32	50,000	Number of Analog Input 4 Trips
33	50,000	Number of Loss of Excitation Circle 1 Trips
34	50,000	Number of Loss of Excitation Circle 2 Trips
35	50,000	Number of Ground Directional Trips
36	50,000	Number of High Set Phase Overcurrent Trips
37	50,000	Number of Distance Zone 1 Trips
38	50,000	Number of Distance Zone 2 Trips



The counters cannot be cleared with the Freeze/Clear function codes (9/10). Instead, the control relay output block points can be used to clear groups of counters. There is only one copy of each counter, so clearing a counter via Modbus or the front panel display causes the corresponding DNP counter point to be cleared and vice-versa.

6.5.4 ANALOG INPUT / INPUT CHANGE (OBJECTS 30/32)

In the following table, the Format column indicates that the associated data point format is determined by the entry in Table 6–2: DATA FORMATS on page 6–40. For example, an “F1” format is described in that table as a (16-bit) unsigned value without any decimal places. Therefore, the value read should be interpreted in this manner. Many of the values reported by the 489 have a size of 32-bits and have had their upper and lower 16-bit components assigned to separate points. Where indicated, refer to the appropriate note following the table for more detail.

POINT LIST FOR: ANALOG INPUT (OBJECT 30) ANALOG INPUT CHANGE (OBJECT 32) (SHEET 1 OF 4)				
INDEX	FORMAT	DESCRIPTION	EVENT CLASS ASSIGNED TO	NOTES
0	F133	Generator Status	Class 1	Note 3
1	F1	Generator Thermal Capacity Used	Class 1	
2	F1	Estimated Trip Time On Overload (seconds, 65535 means never)	Class 1	
3	F134	Cause Of Last Trip	Class 1	Note 3
4	F19	Time Of Last Trip (Upper 16 Bits)	Class 1	Notes 3,4
5	F19	Time Of Last Trip (Lower 16 Bits)	Class 1	Notes 3,4
6	F18	Date Of Last Trip (Upper 16 Bits)	Class 1	Notes 3,4
7	F18	Date Of Last Trip (Lower 16 Bits)	Class 1	Notes 3,4
8	F1	Tachometer Pre-Trip	Class 1	Note 3
9	F1	Scale factor for pre-trip current readings (pre-trip points marked with “Note 6”). Will always be a power of 10 (1, 10, 100, etc.). Changes only when the configuration setpoints are changed.	Class 1	Note 3
10	F1	Phase A Pre-Trip Current	Class 1	Notes 3, 6
11	F1	Phase B Pre-Trip Current	Class 1	Notes 3, 6
12	F1	Phase C Pre-Trip Current	Class 1	Notes 3, 6
13	F1	Phase A Pre-Trip Differential Current	Class 1	Notes 3, 6
14	F1	Phase B Pre-Trip Differential Current	Class 1	Notes 3, 6
15	F1	Phase C Pre-Trip Differential Current	Class 1	Notes 3, 6
16	F1	Pre-Trip Negative Sequence Current	Class 1	Note 3
17	F1	Ground Current Scale Factor. Will always be a power of 10 (1, 10, 100, etc.). Changes only when the configuration setpoints are changed.	Class 1	Note 3
18	F6	Pre-Trip Ground Current (scaled according to previous setpoint)	Class 1	Note 3
19	F1	Phase A-B Pre-Trip Voltage	Class 1	Note 3
20	F1	Phase B-C Pre-Trip Voltage	Class 1	Note 3
21	F1	Phase C-A Pre-Trip Voltage	Class 1	Note 3
22	F3	Pre-Trip Frequency	Class 1	Note 3
23	F1	Pre-Trip Real Power (MW)	Class 1	Notes 3,8
24	F1	Pre-Trip Real Power (kW)	Class 1	Notes 3,8
25	F1	Pre-Trip Reactive Power (Mar	Class 1	Notes 3,8
26	F1	Pre-Trip Reactive Power (kvar)	Class 1	Notes 3,8
27	F1	Pre-Trip Apparent Power (MVA)	Class 1	Notes 3,8
28	F1	Pre-Trip Apparent Power (kVA)	Class 1	Notes 3,8
29	F1	Last Trip Stator RTD	Class 1	Note 3
30	F4	Last Trip Hottest Stator RTD Temperature (°C)	Class 1	Note 3
31	F1	Last Trip Bearing RTD	Class 1	Note 3
32	F4	Last Trip Hottest Bearing RTD Temperature (°C)	Class 1	Note 3
33	F1	Last Trip Other RTD	Class 1	Note 3
34	F4	Last Trip Hottest Other RTD Temperature (°C)	Class 1	Note 3
35	F1	Last Trip Ambient RTD	Class 1	Note 3
36	F4	Last Trip Hottest Ambient RTD Temperature (°C)	Class 1	Note 3
37	F12	Pre-Trip Analog Input 1	Class 1	Notes 3,9

POINT LIST FOR: ANALOG INPUT (OBJECT 30) ANALOG INPUT CHANGE (OBJECT 32) (SHEET 2 OF 4)				
INDEX	FORMAT	DESCRIPTION	EVENT CLASS ASSIGNED TO	NOTES
38	F12	Pre-Trip Analog Input 2	Class 1	Notes 3,9
39	F12	Pre-Trip Analog Input 3	Class 1	Notes 3,9
40	F12	Pre-Trip Analog Input 4	Class 1	Notes 3,9
41	F1	Pre-Trip Fundamental Frequency Neutral Voltage (volts)	Class 1	Notes 3,10
42	F10	Pre-Trip Fundamental Frequency Neutral Voltage (tenths of a volt)	Class 1	Notes 3,10
43	F1	Pre-Trip Third Harmonic Neutral Voltage (volts)	Class 1	Notes 3,10
44	F10	Pre-Trip Third Harmonic Neutral Voltage (tenths of a volt)	Class 1	Notes 3,10
45	F2	Pre-Trip Vab/lab (loss of excitation impedance)	Class 1	Note 3
46	F1	Pre-Trip Vab/lab Angle (loss of excitation impedance angle)	Class 1	Note 3
47	F1	Scale factor for current readings (points marked with "Note 7"). Will always be a power of 10 (1, 10, 100, etc.). Changes only when the configuration setpoints are changed.	Class 1	Note 3
48	F1	Phase A Output Current	Class 2	Note 7
49	F1	Phase B Output Current	Class 2	Note 7
50	F1	Phase C Output Current	Class 2	Note 7
51	F1	Phase A Neutral-Side Current	Class 2	Note 7
52	F1	Phase B Neutral-Side Current	Class 2	Note 7
53	F1	Phase C Neutral-Side Current	Class 2	Note 7
54	F1	Phase A Differential Current	Class 2	Note 7
55	F1	Phase B Differential Current	Class 2	Note 7
56	F1	Phase C Differential Current	Class 2	Note 7
57	F1	Average Phase Current	Class 2	Note 7
58	F1	Generator Load (percent)	Class 2	
59	F1	Negative Sequence Current	Class 2	
60	F1	Ground Current Scale Factor. Will always be a power of 10 (1, 10, 100, etc.). Changes only when the configuration setpoints are changed.	Class 1	Note 3
61	F3	Ground Current (scaled according to the previous point)	Class 2	
62	F1	Phase A-B Voltage	Class 2	
63	F1	Phase B-C Voltage	Class 2	
64	F1	Phase C-A Voltage	Class 2	
65	F1	Average Line Voltage	Class 2	
66	F1	Phase A-N Voltage	Class 2	
67	F1	Phase B-N Voltage	Class 2	
68	F1	Phase C-N Voltage	Class 2	
69	F1	Average Phase Voltage	Class 2	
70	F3	Per Unit Measurement Of V/Hz	Class 2	
71	F3	Frequency	Class 2	Note 2
72	F1	Fundamental Frequency Neutral Voltage (volts)	Class 2	Note 10
73	F10	Fundamental Frequency Neutral Voltage (tenths of a volt)	Class 2	Note 10
74	F1	Third Harmonic Neutral Voltage (volts)	Class 2	Note 10
75	F10	Third Harmonic Neutral Voltage (tenths of a volt)	Class 2	Note 10
76	F1	Third Harmonic Terminal Voltage (volts)	Class 2	Note 10
77	F10	Third Harmonic Terminal Voltage (tenths of a volt)	Class 2	Note 10
78	F2	Vab/lab (loss of excitation impedance)	Class 2	
79	F1	Vab/lab Angle (loss of excitation impedance angle)	Class 2	
80	F6	Power Factor	Class 2	
81	F1	Real Power (MW)	Class 2	Note 8

POINT LIST FOR: ANALOG INPUT (OBJECT 30) ANALOG INPUT CHANGE (OBJECT 32) (SHEET 3 OF 4)				
INDEX	FORMAT	DESCRIPTION	EVENT CLASS ASSIGNED TO	NOTES
82	F1	Real Power (kW)	Class 2	Note 8
83	F1	Reactive Power (Mar)	Class 2	Note 8
84	F1	Reactive Power (kvar)	Class 2	Note 8
85	F1	Apparent Power (MVA)	Class 2	Note 8
86	F1	Apparent Power (kVA)	Class 2	Note 8
87	F1	Hottest Stator RTD	Class 2	Note 3
88	F4	Hottest Stator RTD Temperature (°C)	Class 2	
89	F4	RTD #1 Temperature (°C)	Class 2	
90	F4	RTD #2 Temperature (°C)	Class 2	
91	F4	RTD #3 Temperature (°C)	Class 2	
92	F4	RTD #4 Temperature (°C)	Class 2	
93	F4	RTD #5 Temperature (°C)	Class 2	
94	F4	RTD #6 Temperature (°C)	Class 2	
95	F4	RTD #7 Temperature (°C)	Class 2	
96	F4	RTD #8 Temperature (°C)	Class 2	
97	F4	RTD #9 Temperature (°C)	Class 2	
98	F4	RTD #10 Temperature (°C)	Class 2	
99	F4	RTD #11 Temperature (°C)	Class 2	
100	F4	RTD #12 Temperature (°C)	Class 2	
101	F1	Current Demand	Class 2	Note 7
102	F1	MW Demand	Class 2	Note 8
103	F1	kW Demand	Class 2	Note 8
104	F1	Mvar Demand	Class 2	Note 8
105	F1	kvar Demand	Class 2	Note 8
106	F1	MVA Demand	Class 2	Note 8
107	F1	kVA Demand	Class 2	Note 8
108	F1	Peak Current Demand	Class 2	Note 7
109	F1	Peak MW Demand	Class 2	Note 8
110	F1	Peak kW Demand	Class 2	Note 8
111	F1	Peak Mvar Demand	Class 2	Note 8
112	F1	Peak kvar Demand	Class 2	Note 8
113	F1	Peak MVA Demand	Class 2	Note 8
114	F1	Peak kVA Demand	Class 2	Note 8
115	F12	Analog Input 1	Class 2	Note 9
116	F12	Analog Input 2	Class 2	Note 9
117	F12	Analog Input 3	Class 2	Note 9
118	F12	Analog Input 4	Class 2	Note 9
119	F1	Tachometer RPM	Class 2	
120	F1	Average Generator Load	Class 2	
121	F1	Average Negative Sequence Current	Class 2	
122	F1	Average Phase-Phase Voltage	Class 2	
123	-	User Map Value 1		Note 5
124	-	User Map Value 2		Note 5
↓	↓	...↓...	↓	↓
246	-	User Map Value 124		Note 5
247	-	User Map Value 125		Note 5

POINT LIST FOR: ANALOG INPUT (OBJECT 30) ANALOG INPUT CHANGE (OBJECT 32) (SHEET 4 OF 4)				
INDEX	FORMAT	DESCRIPTION	EVENT CLASS ASSIGNED TO	NOTES
248	F118	Active Setpoint Group	Class 1	Note 3
249	F13	Positive kWh	Class 2	
250	F13	Positive kvarh	Class 2	
251	F13	Negative kvarh	Class 2	
252	F12	Generator Hours Online	Class 2	

TABLE NOTES:

1. Unless otherwise specified, an event object will be generated for a point if the current value of the point changes by an amount greater than or equal to two percent of its previous value.
2. An event object is created for the Frequency point if the frequency changes by 0.04 Hz or more from its previous value.
3. An event object is created for these points if the current value of a point is in any way changed from its previous value.
4. To support existing SCADA hardware that is not capable of 32-bit data reads, the upper and lower 16-bit portions of these 32-bit values have been assigned to separate points. To read this data, it is necessary to read both the upper and lower 16-bit portions, concatenate these two values to form a 32-bit value and interpret the result in the format associated with the point as specified in Table 6–2: DATA FORMATS on page 6–40.
5. The data returned by a read of the User Map Value points is determined by the values programmed into the corresponding User Map Address registers (which are only accessible via Modbus). Refer to Section 6.3.2: USER DEFINABLE MEMORY MAP AREA on page 6–9 for more information. Changes in User Map Value points never generate event objects. Note that it is possible to refer to a 32-bit quantity in a user map register, which may require the use of a 32-bit variation to read the associated analog input point.
6. The scale for pre-trip currents is determined by the value in point 9, which should not normally change
7. The scale for currents is determined by the value in point 47, which should not normally change
8. Each power quantity is available at two different points, with two different scale factors (kW and MW, for example). The user should select the unit which is closest to providing the resolution and range desired. If 32-bit analog input capability is present, the higher-resolution (kW, kvar, kVA) points should generally be used, since they provide the greatest resolution.
9. Analog input values may be –50000 to +50000 if so configured. Therefore, 32-bit analog input capability is required to read the full possible range. If the SCADA equipment can only read 16-bit registers, the analog inputs should be configured to operate within the range –32768 to +32767.
10. Each neutral voltage quantity is available at two different points, with two different scale factors (volts and tenths of a volt). The user should select the unit which is closest to providing the resolution and range desired. If 32-bit analog input capability is present, the higher-resolution (tenths of a volt) points should generally be used, since they provide the greatest resolution.

7.1.1 TEST CONTENTS

The purpose of this testing description is to demonstrate the procedures necessary to perform a complete functional test of all the 489 hardware while also testing firmware/hardware interaction in the process. Since the 489 is packaged in a draw-out case, a demo case (metal carry case in which the 489 may be mounted) may be useful for creating a portable test set with a wiring harness for all of the inputs and outputs. Testing of the relay during commissioning using a primary injection test set will ensure that CTs and wiring are correct and complete.

The 489 tests are listed below. For the following tests refer to Figure 7–1: SECONDARY INJECTION TEST SETUP on page 7–2:

1. OUTPUT CURRENT ACCURACY TEST
2. PHASE VOLTAGE INPUT ACCURACY TEST
3. GROUND, NEUTRAL AND DIFFERENTIAL CURRENT ACCURACY TEST
4. NEUTRAL VOLTAGE (FUNDAMENTAL) ACCURACY TEST
5. NEGATIVE SEQUENCE CURRENT ACCURACY TEST
6. RTD ACCURACY TEST
7. DIGITAL INPUT AND TRIP COIL SUPERVISION TEST
8. ANALOG INPUT AND OUTPUTS TEST
9. OUTPUT RELAY TEST
10. OVERLOAD CURVE TEST
11. POWER MEASUREMENT TEST
12. REACTIVE POWER TEST
13. VOLTAGE PHASE REVERSAL TEST

For the following tests refer to Figure 7–2: SECONDARY INJECTION SETUP #2 on page 7–12:

14. GE POWER MANAGEMENT (HGF) GROUND CURRENT ACCURACY TEST
15. NEUTRAL VOLTAGE (3RD HARMONIC) ACCURACY TEST
16. PHASE DIFFERENTIAL TRIP TEST

For the following test refer to Figure 7–4: SECONDARY INJECTION TEST SETUP #3 on page 7–15:

17. VOLTAGE RESTRAINED OVERCURRENT

7.1.2 SECONDARY INJECTION TEST SETUP

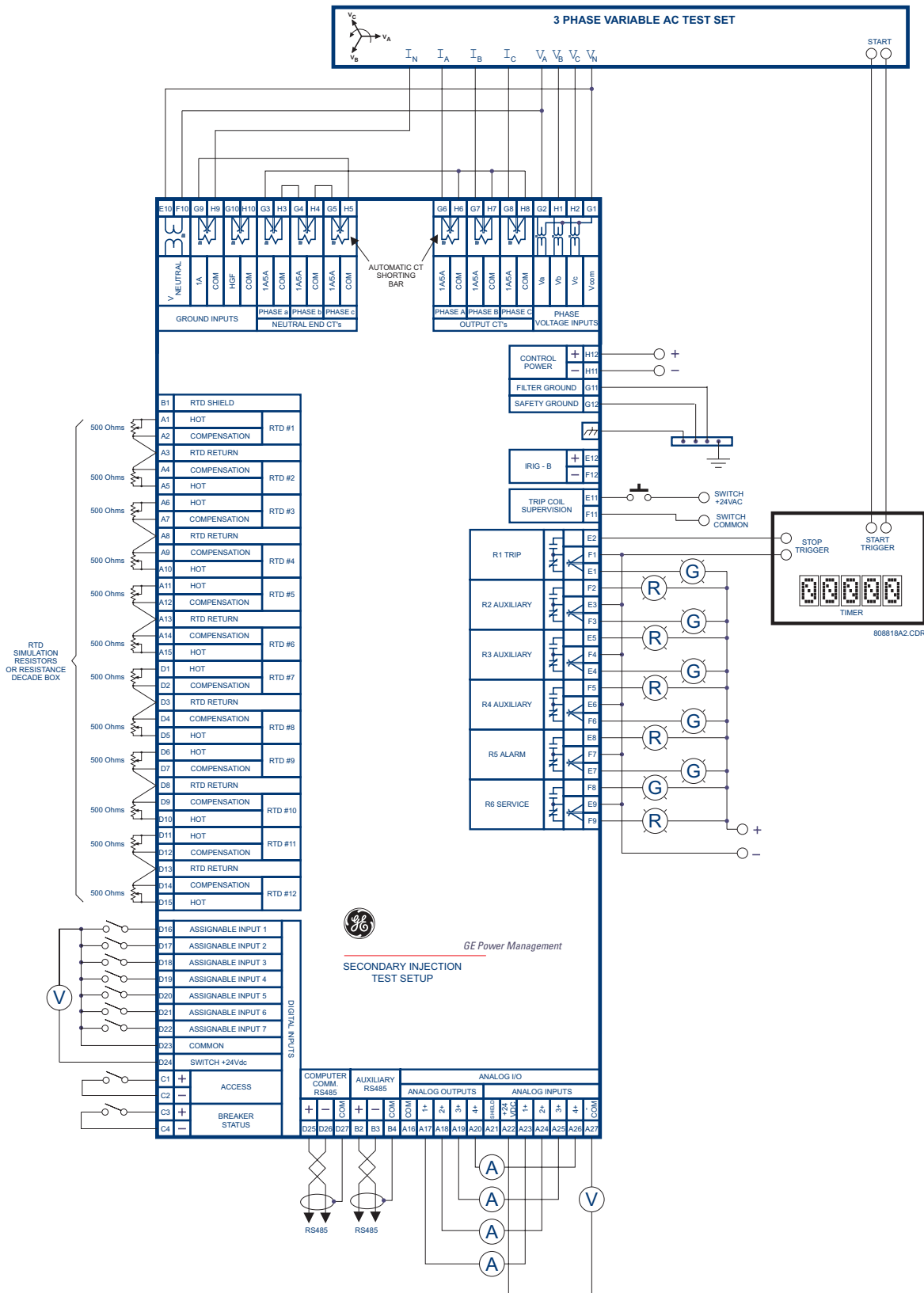

Figure 7-1: SECONDARY INJECTION TEST SETUP

7

7.2.1 OUTPUT CURRENT ACCURACY

The specification for output and neutral end current input is $\pm 0.5\%$ of $2 \times CT$ when the injected current is less than $2 \times CT$. Perform the steps below to verify accuracy.

1. Alter the following setpoint:

S2 SYSTEM SETUP\CURRENT SENSING\PHASE CT PRIMARY: 1000A

2. Measured values should be ± 10 A. Inject the values shown in the table below and verify accuracy of the measured values. View the measured values in:

A2 METERING DATA\CURRENT METERING

INJECTED CURRENT		EXPECTED CURRENT	MEASURED CURRENT		
1 A UNIT	5 A UNIT		PHASE A	PHASE B	PHASE C
0.1 A	0.5 A	100 A			
0.2 A	1.0 A	200 A			
0.5 A	2.5 A	500 A			
1 A	5 A	1000 A			
1.5 A	7.5 A	1500 A			
2 A	10 A	2000 A			

7.2.2 PHASE VOLTAGE INPUT ACCURACY

The specification for phase voltage input accuracy is $\pm 0.5\%$ of full scale (200 V). Perform the steps below to verify accuracy.

1. Alter the following setpoints:

S2 SYSTEM SETUP\VOLTAGE SENSING\VT CONNECTION TYPE: Wye

S2 SYSTEM SETUP\VOLTAGE SENSING\VOLTAGE TRANSFORMER RATIO: 10.00:1

2. Measured values should be ± 1.0 V. Apply the voltage values shown in the table and verify accuracy of the measured values. View the measured values in:

A2 METERING DATA\VOLTAGE METERING

APPLIED LINE-NEUTRAL VOLTAGE	EXPECTED VOLTAGE READING	MEASURED VOLTAGE		
		A-N	B-N	C-N
30 V	300 V			
50 V	500 V			
100 V	1000 V			
150 V	1500 V			
200 V	2000 V			
270 V	2700 V			

7.2.3 GROUND (1A), NEUTRAL AND DIFFERENTIAL CURRENT ACCURACY

The specification for neutral, differential and 1 A ground current input accuracy is $\pm 0.5\%$ of $2 \times CT$. Perform the steps below to verify accuracy.

- Alter the following setpoints:

S2 SYSTEM SETUP\CURRENT SENSING\GROUND CT: 1A Secondary
S2 SYSTEM SETUP\CURRENT SENSING\GROUND CT RATIO: 1000:1
S2 SYSTEM SETUP\CURRENT SENSING\PHASE CT PRIMARY: 1000 A

S5 CURRENT ELEMENTS\PHASE DIFFERENTIAL\PHASE DIFFERENTIAL TRIP: unlatched
S5 CURRENT ELEMENTS\PHASE DIFFERENTIAL\DIFFERENTIAL TRIP MIN. PICKUP: 0.1xCT

- Note: the last two setpoints are needed to view the neutral and the differential current. The trip element will operate when differential current exceeds 100 A.
- Measured values should be ± 10 A. Inject (I_A only) the values shown in the table below into one phase only and verify accuracy of the measured values. View the measured values in:

A2 METERING DATA\CURRENT METERING

or press the **NEXT** key to view the current values when differential trip element is active.

Table 7-1: NEUTRAL AND GROUND CURRENT TEST

INJECTED CURRENT 1 A UNIT	EXPECTED CURRENT READING	MEASURED GROUND CURRENT	MEASURED NEUTRAL CURRENT		
			PHASE A	PHASE B	PHASE C
0.1 A	100 A				
0.2 A	200 A				
0.5 A	500 A				
1 A	1000 A				

Table 7-2: DIFFERENTIAL CURRENT TEST

INJECTED CURRENT	EXPECTED CURRENT READING		MEASURED DIFFERENTIAL CURRENT		
	DIFF. PHASE A	DIFF PHASE B,C	PHASE A	PHASE B	PHASE C
0.1 A	200 A	100 A			
0.2 A	400 A	200 A			
0.5 A	1000 A	500 A			
1 A	2000 A	1000 A			

7.2.4 NEUTRAL VOLTAGE (FUNDAMENTAL) ACCURACY

The specification for neutral voltage (fundamental) accuracy is $\pm 0.5\%$ of full scale (100 V). Perform the steps below to verify accuracy.

- Alter the following setpoints:

S2 SYSTEM SETUP\VOLTAGE SENSING\NEUTRAL VOLTAGE TRANSFORMER: Yes
S2 SYSTEM SETUP\VOLTAGE SENSING\NEUTRAL V.T. RATIO: 10.00:1
S2 SYSTEM SETUP\GEN. PARAMETERS\GENERATOR NOMINAL FREQUENCY: 60 Hz

- Measured values should be ± 5.0 V. Apply the voltage values shown in the table and verify accuracy of the measured values. View the measured values in:

A2 METERING DATA\VOLTAGE METERING

APPLIED NEUTRAL VOLTAGE AT 60 HZ	EXPECTED NEUTRAL VOLTAGE	MEASURED NEUTRAL VOLTAGE
10 V	100 V	
30 V	300 V	
50 V	500 V	

7.2.5 NEGATIVE SEQUENCE CURRENT ACCURACY

The 489 measures negative sequence current as a percent of Full Load Amperes (FLA). A sample calculation of negative sequence current is shown below. Given the following generator parameters:

$$\text{Rated MVA } (P_A) = 1.04$$

$$\text{Voltage Phase to Phase } (V_{pp}): 600 \text{ V}$$

$$\text{we have: FLA} = \frac{P_A}{\sqrt{3} \times V_{pp}} = \frac{1.04 \times 10^6}{\sqrt{3} \times 600} = 1000 \text{ A}$$

With the following output currents:

$$I_a = 780 \angle 0^\circ, \quad I_b = 1000 \angle 113^\circ \text{ lag}, \quad I_c = 1000 \angle 247^\circ \text{ lag}$$

The negative-sequence current I_{ns} is calculated as:

$$\begin{aligned} I_{ns} &= \frac{1}{3}(I_a + a^2 I_b + a I_c) \quad \text{where } a = 1 \angle 120^\circ = -0.5 + j0.866 \\ &= \frac{1}{3}(780 \angle 0^\circ + (1 \angle 120^\circ)^2 (1000 \angle -113^\circ) + (1 \angle 120^\circ)(1000 \angle 113^\circ)) \\ &= \frac{1}{3}(780 \angle 0^\circ + 1000 \angle 127^\circ + 1000 \angle 233^\circ) = \frac{1}{3}(780 - 601.8 + j798.6 - 601.8 - j798.6) \\ &= -141.2 \\ \Rightarrow \%I_{ns} &= \frac{I_{ns}}{\text{FLA}} \times 100 = 14\% \end{aligned}$$

Therefore, the negative sequence current is 14% of FLA. The specification for negative sequence current accuracy is per output current inputs. Perform the steps below to verify accuracy.

- Alter the following setpoints:

S2 SYSTEM SETUP\GENERATOR PARAMETER\GENERATOR RATED MVA: 1.04

S2 SYSTEM SETUP\GENERATOR PARAMETER\VOLTAGE PHASE-PHASE: 600

(Note: This is equivalent to setting FLA = 1000 A – For testing purposes ONLY!)

S2 SYSTEM SETUP\CURRENT SENSING\PHASE CT PRIMARY: 1000A

- Inject the values shown in the table below and verify accuracy of the measured values. View the measured values in:

A2 METERING DATA\CURRENT METERING

INJECTED CURRENT		EXPECTED NEGATIVE SEQUENCE CURRENT LEVEL	MEASURED NEGATIVE SEQUENCE CURRENT LEVEL
1 A UNIT	5 A UNIT		
$I_a = 0.78 \text{ A } \angle 0^\circ$ $I_b = 1 \text{ A } \angle 113^\circ \text{ lag}$ $I_c = 1 \text{ A } \angle 247^\circ \text{ lag}$	$I_a = 3.9 \text{ A } \angle 0^\circ$ $I_b = 5 \text{ A } \angle 113^\circ \text{ lag}$ $I_c = 5 \text{ A } \angle 247^\circ \text{ lag}$	14% FLA	
$I_a = 1.56 \text{ A } \angle 0^\circ$ $I_b = 2 \text{ A } \angle 113^\circ \text{ lag}$ $I_c = 2 \text{ A } \angle 247^\circ \text{ lag}$	$I_a = 7.8 \text{ A } \angle 0^\circ$ $I_b = 10 \text{ A } \angle 113^\circ \text{ lag}$ $I_c = 10 \text{ A } \angle 247^\circ \text{ lag}$	28% FLA	
$I_a = 0.39 \text{ A } \angle 0^\circ$ $I_b = 0.5 \text{ A } \angle 113^\circ \text{ lag}$ $I_c = 0.5 \text{ A } \angle 247^\circ \text{ lag}$	$I_a = 1.95 \text{ A } \angle 0^\circ$ $I_b = 2.5 \text{ A } \angle 113^\circ \text{ lag}$ $I_c = 2.5 \text{ A } \angle 247^\circ \text{ lag}$	7% FLA	

7.2.6 RTD ACCURACY

The specification for RTD input accuracy is $\pm 2^\circ$ for Platinum/Nickel and $\pm 5^\circ$ for Copper. Perform the steps below.

- Alter the following setpoints:

S8 RTD TEMPERATURE\RTD TYPE\STATOR RTD TYPE: 100 ohm Platinum (select desired type)

S8 RTD TEMPERATURE\RTD #1\RTD #1 APPLICATION: Stator (repeat for RTDs 2 to 12)

- Measured values should be $\pm 2^\circ\text{C}$ / $\pm 4^\circ\text{F}$ for platinum/nickel and $\pm 5^\circ\text{C}$ / $\pm 9^\circ\text{F}$ for copper. Alter the resistance applied to the RTD inputs as shown below to simulate RTDs and verify accuracy. View the measured values in **A2 METERING DATA\TEMPERATURE**.

APPLIED RESISTANCE 100 Ω PLATINUM	EXPECTED RTD TEMPERATURE READING		MEASURED RTD TEMPERATURE SELECT ONE: ____ $^\circ\text{C}$ ____ $^\circ\text{F}$											
	$^\circ\text{C}$	$^\circ\text{F}$	1	2	3	4	5	6	7	8	9	10	11	12
84.27 Ω	-40 $^\circ\text{C}$	-40 $^\circ\text{F}$												
100.00 Ω	0 $^\circ\text{C}$	32 $^\circ\text{F}$												
119.39 Ω	50 $^\circ\text{C}$	122 $^\circ\text{F}$												
138.50 Ω	100 $^\circ\text{C}$	212 $^\circ\text{F}$												
157.32 Ω	150 $^\circ\text{C}$	302 $^\circ\text{F}$												
175.84 Ω	200 $^\circ\text{C}$	392 $^\circ\text{F}$												
194.08 Ω	250 $^\circ\text{C}$	482 $^\circ\text{F}$												

APPLIED RESISTANCE 120 Ω NICKEL	EXPECTED RTD TEMPERATURE READING		MEASURED RTD TEMPERATURE SELECT ONE: ____ $^\circ\text{C}$ ____ $^\circ\text{F}$											
	$^\circ\text{C}$	$^\circ\text{F}$	1	2	3	4	5	6	7	8	9	10	11	12
92.76 Ω	-40 $^\circ\text{C}$	-40 $^\circ\text{F}$												
120.00 Ω	0 $^\circ\text{C}$	32 $^\circ\text{F}$												
157.74 Ω	50 $^\circ\text{C}$	122 $^\circ\text{F}$												
200.64 Ω	100 $^\circ\text{C}$	212 $^\circ\text{F}$												
248.95 Ω	150 $^\circ\text{C}$	302 $^\circ\text{F}$												
303.46 Ω	200 $^\circ\text{C}$	392 $^\circ\text{F}$												
366.53 Ω	250 $^\circ\text{C}$	482 $^\circ\text{F}$												

APPLIED RESISTANCE 100 Ω NICKEL	EXPECTED RTD TEMPERATURE READING		MEASURED RTD TEMPERATURE SELECT ONE: ____ $^\circ\text{C}$ ____ $^\circ\text{F}$											
	$^\circ\text{C}$	$^\circ\text{F}$	1	2	3	4	5	6	7	8	9	10	11	12
77.30 Ω	-40 $^\circ\text{C}$	-40 $^\circ\text{F}$												
100.00 Ω	0 $^\circ\text{C}$	32 $^\circ\text{F}$												
131.45 Ω	50 $^\circ\text{C}$	122 $^\circ\text{F}$												
167.20 Ω	100 $^\circ\text{C}$	212 $^\circ\text{F}$												
207.45 Ω	150 $^\circ\text{C}$	302 $^\circ\text{F}$												
252.88 Ω	200 $^\circ\text{C}$	392 $^\circ\text{F}$												
305.44 Ω	250 $^\circ\text{C}$	482 $^\circ\text{F}$												

APPLIED RESISTANCE 10 Ω COPPER	EXPECTED RTD TEMPERATURE READING		MEASURED RTD TEMPERATURE SELECT ONE: ____ $^\circ\text{C}$ ____ $^\circ\text{F}$											
	$^\circ\text{C}$	$^\circ\text{F}$	1	2	3	4	5	6	7	8	9	10	11	12
7.49 Ω	-40 $^\circ\text{C}$	-40 $^\circ\text{F}$												
9.04 Ω	0 $^\circ\text{C}$	32 $^\circ\text{F}$												
10.97 Ω	50 $^\circ\text{C}$	122 $^\circ\text{F}$												
12.90 Ω	100 $^\circ\text{C}$	212 $^\circ\text{F}$												
14.83 Ω	150 $^\circ\text{C}$	302 $^\circ\text{F}$												
16.78 Ω	200 $^\circ\text{C}$	392 $^\circ\text{F}$												
18.73 Ω	250 $^\circ\text{C}$	482 $^\circ\text{F}$												

7

7.2.7 DIGITAL INPUTS AND TRIP COIL SUPERVISION

The digital inputs and trip coil supervision can be verified easily with a simple switch or pushbutton. Verify the SWITCH +24 V DC with a voltmeter. Perform the steps below to verify functionality of the digital inputs.

1. Open switches of all of the digital inputs and the trip coil supervision circuit.
2. View the status of the digital inputs and trip coil supervision in:

A1 STATUSDIGITAL INPUTS

3. Close switches of all of the digital inputs and the trip coil supervision circuit.
4. View the status of the digital inputs and trip coil supervision in:

A1 STATUSDIGITAL INPUTS

INPUT	EXPECTED STATUS (SWITCH OPEN)	✓ PASS ✗ FAIL	EXPECTED STATUS (SWITCH CLOSED)	✓ PASS ✗ FAIL
ACCESS	Open		Shorted	
BREAKER STATUS	Open		Shorted	
ASSIGNABLE INPUT 1	Open		Shorted	
ASSIGNABLE INPUT 2	Open		Shorted	
ASSIGNABLE INPUT 3	Open		Shorted	
ASSIGNABLE INPUT 4	Open		Shorted	
ASSIGNABLE INPUT 5	Open		Shorted	
ASSIGNABLE INPUT 6	Open		Shorted	
ASSIGNABLE INPUT 7	Open		Shorted	
TRIP COIL SUPERVISION	No Coil		Coil	

7.2.8 ANALOG INPUTS AND OUTPUTS

The specification for analog input and analog output accuracy is $\pm 1\%$ of full scale. Perform the steps below to verify accuracy. Verify the Analog Input +24 V DC with a voltmeter.

a) 4-20mA

1. Alter the following setpoints:

S11 ANALOG I/OANALOG INPUT1ANALOG INPUT1: 4-20 mA

S11 ANALOG I/OANALOG INPUT1ANALOG INPUT1 MINIMUM: 0

S11 ANALOG I/OANALOG INPUT1ANALOG INPUT1 MAXIMUM: 1000 (repeat all for analog inputs 2 to 4)

2. Analog output values should be ± 0.2 mA on the ammeter. Measured analog input values should be ± 10 units. Force the analog outputs using the following setpoints:

S12 TESTINGTEST ANALOG OUTPUTFORCE ANALOG OUTPUTS FUNCTION: Enabled

S12 TESTINGTEST ANALOG OUTPUTANALOG OUTPUT 1 FORCED VALUE: 0% (enter %, repeat for outputs 2 to 4)

3. Verify the ammeter readings as well as the measured analog input readings. For the purposes of testing, the analog input is fed in from the analog output (see Figure 7-1). View the measured values in:

A2 METERING DATAANALOG INPUTS**Table 7-3: ANALOG INPUT/OUTPUT TEST, 4 to 20 mA INPUT**

ANALOG OUTPUT FORCE VALUE	EXPECTED AMMETER READING	MEASURED AMMETER READING (MA)				EXPECTED ANALOG INPUT READING	MEASURED ANALOG INPUT READING (UNITS)			
		1	2	3	4		1	2	3	4
0%	4 mA					0 units				
25%	8 mA					250 units				
50%	12 mA					500 units				
75%	16 mA					750 units				
100%	20 mA					1000 units				

b) 0-1mA

- Alter the following setpoints:

S11 ANALOG I/OANALOG INPUT1\ANALOG INPUT1: 0-1 mA

S11 ANALOG I/OANALOG INPUT1\ANALOG INPUT1 MINIMUM: 0

S11 ANALOG I/OANALOG INPUT1\ANALOG INPUT1 MAXIMUM: 1000 (repeat for analog inputs 2 to 4)

- Analog output values should be ±0.01 mA on the ammeter. Measured analog input values should be ±10 units. Force the analog outputs using the following setpoints:

S12 TESTING\TEST ANALOG OUTPUT\FORCE ANALOG OUTPUTS FUNCTION: Enabled

S12 TESTING\TEST ANALOG OUTPUT\ANALOG OUTPUT 1 FORCED VALUE: 0% (enter %, repeat for outputs 2 to 4)

Verify the ammeter readings as well as the measured analog input readings. View the measured values in:

A2 METERING DATA\ANALOG INPUTS

Table 7-4: ANALOG INPUT/OUTPUT TEST, 0 to 1 mA INPUT

ANALOG OUTPUT FORCE VALUE	EXPECTED AMMETER READING	MEASURED AMMETER READING (mA)				EXPECTED ANALOG INPUT READING	MEASURED ANALOG INPUT READING (UNITS)			
		1	2	3	4		1	2	3	4
0%	0 mA					0 units				
25%	0.25 mA					250 units				
50%	0.50 mA					500 units				
75%	0.75 mA					750 units				
100%	1.00 mA					1000 units				

7.2.9 OUTPUT RELAYS

To verify the functionality of the output relays, perform the following steps:

- Using the setpoint:

S12 TESTING\TEST OUTPUT RELAYS\FORCE OPERATION OF RELAYS: R1 TRIP

select and store values as per the table below, verifying operation

Table 7-5: OUTPUT RELAYS

FORCE OPERATION SETPOINT	EXPECTED MEASUREMENT (✓ FOR SHORT)												ACTUAL MEASUREMENT (✓ FOR SHORT)											
	R1		R2		R3		R4		R5		R6		R1		R2		R3		R4		R5		R6	
	NO	NC	NO	NC	NO	NC	NO	NC	NO	NC	NO	NC	NO	NC	NO	NC	NO	NC	NO	NC	NO	NC	NO	NC
R1 Trip	✓		✓		✓		✓		✓		✓													
R2 Auxiliary		✓	✓		✓		✓		✓		✓													
R3 Auxiliary		✓		✓	✓		✓		✓		✓													
R4 Auxiliary		✓		✓		✓	✓		✓		✓													
R5 Alarm		✓		✓		✓		✓	✓		✓													
R6 Service		✓		✓		✓		✓		✓		✓												
All Relays	✓		✓		✓		✓		✓		✓		✓											
No Relays		✓		✓		✓		✓		✓		✓												



R6 Service relay is failsafe or energized normally, operating R6 causes it to de-energize.

NOTE

7.3.1 OVERLOAD CURVE TEST

The specification for overload curve timing accuracy is ± 100 ms or $\pm 2\%$ of time to trip. Pickup accuracy is as per the current inputs ($\pm 0.5\%$ of $2 \times CT$ when the injected current is less than $2 \times CT$ and $\pm 1\%$ of $20 \times CT$ when the injected current is equal to or greater than $2 \times CT$). Perform the steps below to verify accuracy.

1. Alter the following setpoints:

S2 SYSTEM SETUP\GEN. PARAMETERS\GENERATOR RATED: 1.04

S2 SYSTEM SETUP\GEN. PARAMETERS\GENERATOR VOLTAGE PHASE-PHASE: 600

(Note: This is equivalent to setting FLA = 1000 A – For testing purposes ONLY!)

S2 SYSTEM SETUP\CURRENT SENSING\PHASE CT PRIMARY: 1000

S9 THERMAL MODEL\MODEL SETUP\SELECT CURVE STYLE: Standard

S9 THERMAL MODEL\MODEL SETUP\OVERLOAD PICKUP LEVEL: 1.10xFLA

S9 THERMAL MODEL\MODEL SETUP\UNBALANCE BIAS K FACTOR: 0

S9 THERMAL MODEL\MODEL SETUP\HOT/COLD SAFE STALL RATIO: 1.00

S9 THERMAL MODEL\MODEL SETUP\ENABLE RTD BIASING: No

S9 THERMAL MODEL\MODEL SETUP\STANDARD OVERLOAD CURVE NUMBER: 4

S9 THERMAL MODEL\MODEL SETUP\ENABLE THERMAL MODEL: Yes

S9 THERMAL MODEL\THERMAL ELEMENTS\THERMAL MODEL TRIP: Latched or Unlatched

2. Any trip must be reset prior to each test. Short the emergency restart terminals momentarily immediately prior to each overload curve test to ensure that the thermal capacity used is zero. Failure to do so will result in shorter trip times. Inject the current of the proper amplitude to obtain the values as shown and verify the trip times. Motor load may be viewed in:

A2 METERING DATA\CURRENT METERING

3. Thermal capacity used and estimated time to trip may be viewed in:

A1 STATUS\GENERATOR STATUS

AVERAGE PHASE CURRENT DISPLAYED	PICKUP LEVEL	EXPECTED TIME TO TRIP	TOLERANCE RANGE	MEASURED TIME TO TRIP (SEC.)
1050 A	$1.05 \times FLA$	never	n/a	
1200 A	$1.20 \times FLA$	795.44 sec.	779.53 to 811.35 sec.	
1750 A	$1.75 \times FLA$	169.66 sec.	166.27 to 173.05 sec.	
3000 A	$3.00 \times FLA$	43.73 sec.	42.86 to 44.60 sec.	
6000 A	$6.00 \times FLA$	9.99 sec.	9.79 to 10.19 sec.	
10000 A	$10.00 \times FLA$	5.55 sec.	5.44 to 5.66 sec.	



$$FLA = \frac{\text{Generator Rated MVA}}{\sqrt{3} \times \text{Generator Phase-to-Phase Voltage}}$$

7.3.2 POWER MEASUREMENT TEST

The specification for reactive and apparent power is $\pm 1\%$ of $\sqrt{3} \times 2 \times CT \times VT \times VT_{full-scale}$ at $I_{avg} < 2 \times CT$. Perform the steps below to verify accuracy.

- Alter the following setpoints:

S2 SYSTEM SETUP\CURRENT SENSING\PHASE CT PRIMARY: 1000

S2 SYSTEM SETUP\VOLTAGE SENSING\VT CONNECTION TYPE: Wye

S2 SYSTEM SETUP\VOLTAGE SENSING\VOLTAGE TRANSFORMER RATIO: 10.00:1

- Inject current and apply voltage as per the table below. Verify accuracy of the measured values. View the measured values in:

A2 METERING DATA\POWER METERING

INJECTED CURRENT / APPLIED VOLTAGE (IA IS THE REFERENCE VECTOR)		POWER QUANTITY			POWER FACTOR	
1 A UNIT	5 A UNIT	EXPECTED	TOLERANCE	MEASURED	EXPECTED	MEASURED
Ia = 1 A∠0° Ib = 1 A∠120° lag Ic = 1 A∠240° lag Va = 120 V∠342° lag Vb = 120 V∠102° lag Vc = 120 V∠222° lag	Ia = 5 A∠0° Ib = 5 A∠120° lag Ic = 5 A∠240° lag Va = 120 V∠342° lag Vb = 120 V∠102° lag Vc = 120 V∠222° lag	+3424 kW	3329 to 3519 kW		0.95 lag	
Ia = 1 A∠0° Ib = 1 A∠120° lag Ic = 1 A∠240° lag Va = 120 V∠288° lag Vb = 120 V∠48° lag Vc = 120 V∠168° lag	Ia = 5 A∠0° Ib = 5 A∠120° lag Ic = 5 A∠240° lag Va = 120 V∠288° lag Vb = 120 V∠48° lag Vc = 120 V∠168° lag	+3424 kvar	3329 to 3519 kvar		0.31 lag	

7.3.3 REACTIVE POWER TEST

The specification for reactive power is $\pm 1\%$ of $\sqrt{3} \times 2 \times CT \times VT \times VT_{full\ scale}$ at $I_{avg} < 2 \times CT$. Perform the steps below to verify accuracy and trip element.

- Alter the following system setpoints:

S2 SYSTEM SETUP\CURRENT SENSING\PHASE CT PRIMARY: 5000
S2 SYSTEM SETUP\VOLTAGE SENSING\VT CONNECTION TYPE: Wye
S2 SYSTEM SETUP\VOLTAGE SENSING\VOLTAGE TRANSFORMER RATIO: 100:1
S2 SYSTEM SETUP\GEN. PARAMETERS\GENERATOR RATED MVA: 100
S2 SYSTEM SETUP\GEN. PARAMETERS\GENERATOR RATED POWER FACTOR: 0.85
S2 SYSTEM SETUP\GEN. PARAMETERS\GENERATOR VOLTAGE PHASE-PHASE: 12000

The rated reactive power is $100 \sin(\cos^{-1}(0.85)) = \pm 52.7$ Mvar .

- Alter the following reactive power setpoints:

S7 POWER ELEMENTS\REACTIVE POWER\REACTIVE POWER ALARM: Unlatched
S7 POWER ELEMENTS\REACTIVE POWER\ASSIGN ALARM RELAYS(2-5): ---5
S7 POWER ELEMENTS\REACTIVE POWER\POSTIVE Mvar ALARM LEVEL: 0.6 x Rated
S7 POWER ELEMENTS\REACTIVE POWER\NEGATIVE Mvar ALARM LEVEL: 0.6 x Rated
S7 POWER ELEMENTS\REACTIVE POWER\REACTIVE POWER ALARM DELAY: 5 s
S7 POWER ELEMENTS\REACTIVE POWER\REACTIVE POWER ALARM EVENT: On
S7 POWER ELEMENTS\REACTIVE POWER\REACTIVE POWER TRIP: Unlatched
S7 POWER ELEMENTS\REACTIVE POWER\ASSIGN TRIP RELAYS(1-4): 1---
S7 POWER ELEMENTS\REACTIVE POWER\POSTIVE Mvar TRIP LEVEL: 0.75 x Rated
S7 POWER ELEMENTS\REACTIVE POWER\NEGATIVE Mvar TRIP LEVEL: 0.75 x Rated
S7 POWER ELEMENTS\REACTIVE POWER\REACTIVE POWER TRIP DELAY: 10 s

- Inject current and apply voltage as per the table below. Verify the alarm/trip elements and the accuracy of the measured values. View the measured values in:

A2 METERING DATA\POWER METERING

- View the Event Records in **A5 EVENT RECORD**

CURRENT/ VOLTAGE	MVAR			ALARM			TRIP		
	EXPECTED	TOLERANCE	MEASURED	EXPECTED	OBSERVED	DELAY	EXPECTED	OBSERVED	DELAY
Vab=120V∠0° Vbc=120V∠120°lag Vca=120V∠240°lag Ian=5 A∠10°lag Ibn=5 A∠130°lag Icn=5 A∠250°lag	18	13 to 23		✗		N/A	✗		N/A
Vab=120V∠0° Vbc=120V∠120°lag Vca=120V∠240°lag Ian=5 A∠340°lag Ibn=5 A∠100°lag Icn=5 A∠220°lag	-35	-40 to -30		✓			✗		N/A
Vab=120V∠0° Vbc=120V∠120°lag Vca=120V∠240°lag Ian=5 A∠330°lag Ibn=5 A∠90°lag Icn=5 A∠210°lag	-52	-57 to -47		✓			✓		
Vab=120V∠0° Vbc=120V∠120°lag Vca=120V∠240°lag Ian=5 A∠30°lag Ibn=5 A∠150°lag Icn=5 A∠270°lag	52	47 to 57		✓			✓		

- ✓ Activated
✗ Not Activated

7.3.4 VOLTAGE PHASE REVERSAL TEST

The can detect voltage phase rotation and protect against phase reversal. To test the phase reversal element, perform the following steps:

- Alter the following setpoints:

S2 SYSTEM SETUP\VOLTAGE SENSING\VT CONNECTION TYPE: Wye

S2 SYSTEM SETUP\GEN. PARAMETERS\GENERATOR PHASE SEQUENCE: ABC

S3 DIGITAL INPUTS\BREAKER STATUS\BREAKER STATUS: Breaker Auxiliary a

S6 VOLTAGE ELEMENTS\PHASE REVERSAL\PHASE REVERSAL TRIP: Unlatched

S6 VOLTAGE ELEMENTS\PHASE REVERSAL\ASSIGN TRIP RELAYS: Trip

- Apply voltages as per the table below. Verify the operation on voltage phase reversal

APPLIED VOLTAGE	EXPECTED RESULT	OBSERVED RESULT
$V_a = 120\text{ V}\angle 0^\circ$ $V_b = 120\text{ V}\angle 120^\circ \text{ lag}$ $V_c = 120\text{ V}\angle 240^\circ \text{ lag}$	NO TRIP	
$V_a = 120\text{ V}\angle 0^\circ$ $V_b = 120\text{ V}\angle 240^\circ \text{ lag}$ $V_c = 120\text{ V}\angle 120^\circ \text{ lag}$	PHASE REVERSAL TRIP	

7.3.5 INJECTION TEST SETUP #2

Setup the 489 device as follows for the following tests.

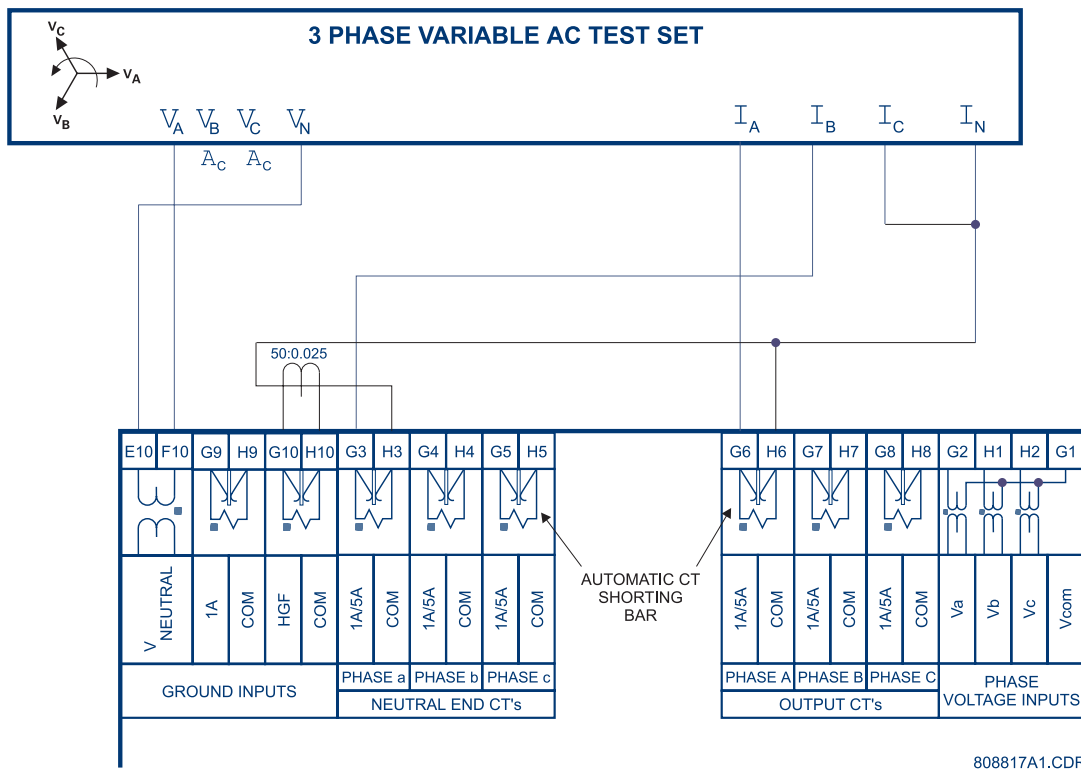

Figure 7–2: SECONDARY INJECTION SETUP #2

808817A1.CDR

7.3.6 GE POWER MANAGEMENT HGF GROUND ACCURACY TEST

The specification for GE Power Management HGF 50:0.025 ground current input accuracy is $\pm 0.5\%$ of $2 \times$ CT rated primary (25 A). Perform the steps below to verify accuracy.

1. Alter the following setpoint:

S2 SYSTEM SETUP\CURRENT SENSING\GROUND CT: 50:0.025 CT

2. Measured values should be ± 0.25 A. Inject the values shown in the table below either as primary values into a GE Power Management 50:0.025 Core Balance CT or as secondary values that simulate the core balance CT. Verify accuracy of the measured values in:

A2 METERING DATA\CURRENT METERING

INJECTED CURRENT		CURRENT READING	
PRIMARY 50:0.025 CT	SECONDARY	EXPECTED	MEASURED
0.25 A	0.125 mA	0.25 A	
1 A	0.5 mA	1.00 A	
5 A	2.5 mA	5.00 A	
10 A	5 mA	10.00 A	

7.3.7 NEUTRAL VOLTAGE (3RD HARMONIC) ACCURACY TEST

The 489 specification for neutral voltage (3rd harmonic) accuracy is $\pm 0.5\%$ of full scale (100 V). Perform the steps below to verify accuracy.

1. Alter the following setpoints:

S2 SYSTEM SETUP\VOLTAGE SENSING\NEUTRAL VOLTAGE TRANSFORMER: Yes

S2 SYSTEM SETUP\VOLTAGE SENSING\NEUTRAL V.T. RATIO: 10.00:1

S2 SYSTEM SETUP\GEN. PARAMETERS\GENERATOR NOMINAL FREQUENCY: 60 Hz

2. Measured values should be ± 5.0 V. Apply the voltage values shown in the table and verify accuracy of the measured values. View the measured values in:

A2 METERING DATA\VOLTAGE METERING

APPLIED NEUTRAL VOLTAGE AT 180 HZ	EXPECTED NEUTRAL VOLTAGE	MEASURED NEUTRAL VOLTAGE
10 V	100 V	
30 V	300 V	
50 V	500 V	

7.3.8 PHASE DIFFERENTIAL TRIP TEST

The 489 phase differential compares the current level at terminal end with the current level at neutral end. The differential element will trip when:

$$I_{diff} > k \times I_{restraint}$$

$$\text{given } I_{diff} = |\bar{I}_A - \bar{I}_a| \text{ and } I_{restraint} = \frac{|I_A| + |I_a|}{2}$$

where: I_{diff} = differential current

$I_{restraint}$ = restraint current

k = differential element characteristic slope in percent

(use **DIFFERENTIAL TRIP SLOPE1** if $I_{restraint} < 2 \times CT$, **DIFFERENTIAL TRIP SLOPE2** if $I_{restraint} \geq 2 \times CT$)

I_A = phase current measured at the output CT

I_a = phase current measured at the neutral end CT

See Section 4.6.8: PHASE DIFFERENTIAL on page 4–26 for additional details.

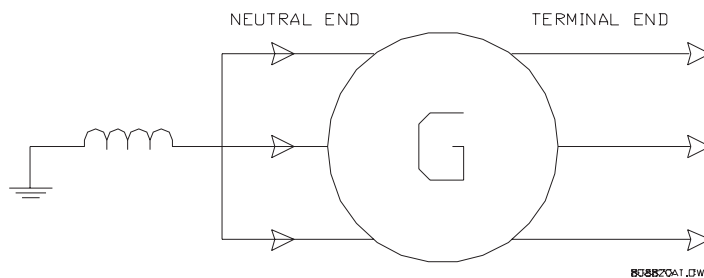

Figure 7-3: PHASE DIFFERENTIAL

The following is a sample calculation of a trip scenario. Given the following settings and values,

DIFFERENTIAL TRIP SLOPE1: 10% (user setting)

DIFFERENTIAL TRIP SLOPE2: 20% (user setting)

$I_A = 1.5 \times CT$ at 0° , $I_a = 1.47 \times CT$ at 190° lag

The calculations are as follows:

$$I_{diff} = |\bar{I}_A - \bar{I}_a| = |1.5 - 1.448 + j0.255| = 0.26 \times CT \text{ and } I_{restraint} = \frac{|I_A| + |I_a|}{2} = 1.485 \times CT$$

Since $I_{restraint} < 2 \times CT$, the differential trip slope $k = 0.1$ or 10% and $I_{trip} = k \times I_{restraint} = 0.1 \times 1.485 = 0.1485 \times CT$.

Therefore, since $I_{diff} > I_{trip}$, the differential TRIP will operate.

The 489 specification for differential phase timing accuracy is $\pm 0.5\%$ of total time. Pickup accuracy is per the output current inputs ($\pm 0.5\%$ of $2 \times CT$ when the injected current is less than $2 \times CT$ and $\pm 1\%$ of $20 \times CT$ when the injected current is equal to or greater than $2 \times CT$). Perform the steps below to verify accuracy for phase A.

1. Alter the following setpoints:

S2 SYSTEM SETUP\CURRENT SENSING\PHASE CT PRIMARY: 1000A

S5 CURRENT ELEMENT\PHASE DIFFERENTIAL\PHASE DIFFERENTIAL TRIP: Unlatched

S5 CURRENT ELEMENT\PHASE DIFFERENTIAL\DIFFERENTIAL TRIP MIN. PICKUP: 0.10xCT

S5 CURRENT ELEMENT\PHASE DIFFERENTIAL\DIFFERENTIAL TRIP SLOPE1: 10%

S5 CURRENT ELEMENT\PHASE DIFFERENTIAL\DIFFERENTIAL TRIP SLOPE2: 20%

2. Measured values should be ± 5.0 A.



There could be further error due to uncertainty in the phase measurement. It is recommended that the phase be measured from 489 instead of the current source for the purposes of this test.

NOTE

Apply the values shown in the table below and verify the accuracy and the operation of phase differential element. View the measured values in:

A2:METERING DATA\CURRENT METERING

or press the **NEXT** button when the trip element is activated.



As in Figure 7-2: SECONDARY INJECTION SETUP #2 on page 7-12, I_A (test set) = I_A and I_B (test set) = I_a

NOTE

APPLIED CURRENT AS SHOWN ON 489	EXPECTED RESULT	EXPECTED DIFFERENTIAL CURRENT	OBSERVED RESULT	MEASURED DIFFERENTIAL CURRENT
$I_A = 1000\text{ A } \angle 0^\circ$ $I_a = 1000\text{ A } \angle 180^\circ \text{ lag}$	NO TRIP	0 A		
$I_A = 1000\text{ A } \angle 0^\circ$ $I_a = 940\text{ A } \angle 190^\circ \text{ lag}$	PHASE DIFFERENTIAL TRIP	179 A		

3. Repeat for phases B & C. Rewiring of Figure 7-2: SECONDARY INJECTION SETUP #2 on page 7-12 is required.

7.3.9 INJECTION TEST SETUP #3

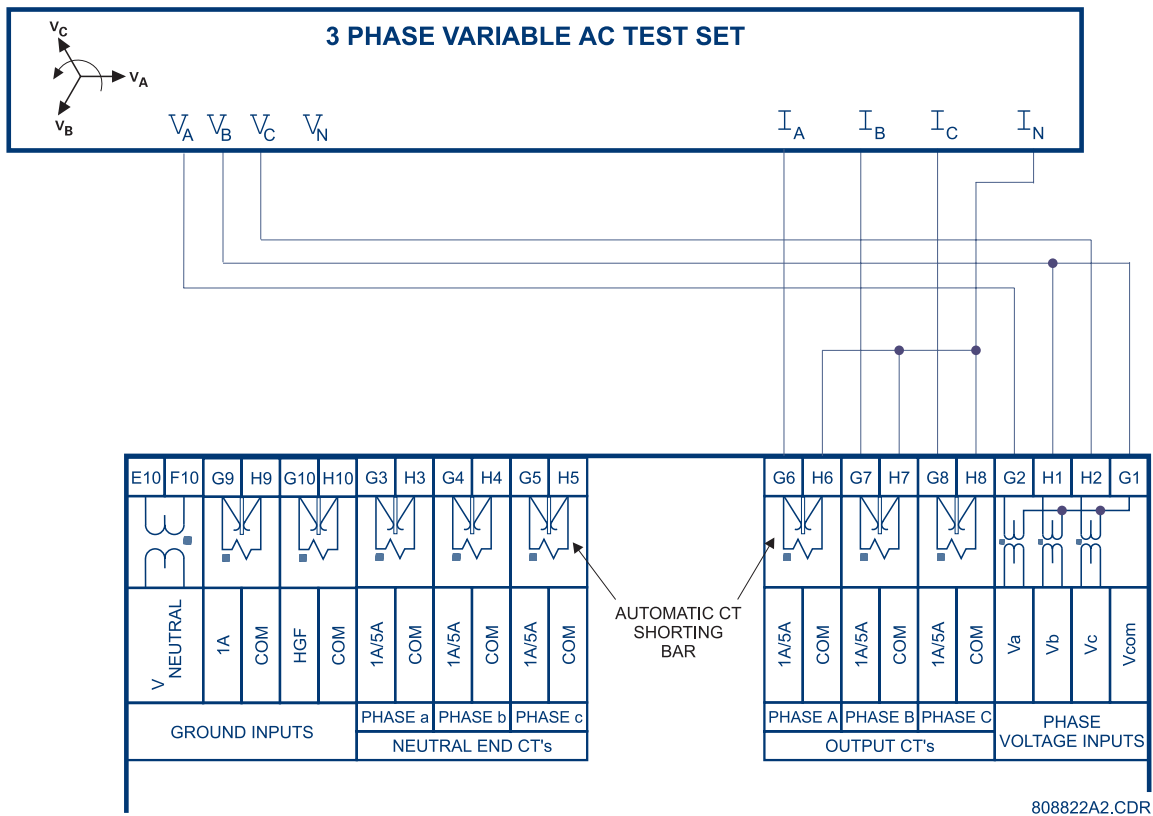

Figure 7-4: SECONDARY INJECTION TEST SETUP #3



7.3.10 VOLTAGE RESTRAINED OVERCURRENT TEST

- Alter the following setpoints.

S2 SYSTEM SETUP\GEN. PARAMETERS\GENERATOR SETTING: 100 MVA
 S2 SYSTEM SETUP\GEN. PARAMETERS\GENERATOR VOLTAGE PHASE-PHASE: 12000
 S2 SYSTEM SETUP\VOLTAGE SENSING\VT CONNECTION TYPE: Open Delta
 S2 SYSTEM SETUP\VOLTAGE SENSING\VOLTAGE TRANSFORMER RATIO: 100:1
 S5 CURRENT ELEMENTS\OVERCURRENT ALARM\OVERCURRENT ALARM: Unlatched
 S5 CURRENT ELEMENTS\OVERCURRENT ALARM\O/C ALARM LEVEL: 1.10 x FLA
 S5 CURRENT ELEMENTS\OVERCURRENT ALARM\OVERCURRENT ALARM DELAY: 2 s
 S5 CURRENT ELEMENTS\OVERCURRENT ALARM\O/C ALARM EVENTS: On
 S5 CURRENT ELEMENTS\PHASE OVERCURRENT\PHASE OVERCURRENT TRIP: Latched
 S5 CURRENT ELEMENTS\PHASE OVERCURRENT\ENABLE VOLTAGE RESTRAINT: Yes
 S5 CURRENT ELEMENTS\PHASE OVERCURRENT\PHASE O/C PICKUP: 1.5 x CT
 S5 CURRENT ELEMENTS\PHASE OVERCURRENT\CURVE SHAPE: ANSI Extremely Inv.
 S5 CURRENT ELEMENTS\PHASE OVERCURRENT\O/C CURVE MULTIPLIER: 2.00
 S5 CURRENT ELEMENTS\PHASE OVERCURRENT\O/C CURVE RESET: Instantaneous

- The trip time for the extremely inverse ANSI curve is given as:

$$\text{Time to Trip} = M \times \left(A + \frac{B}{\frac{I}{\langle K \rangle \times I_p} - C} + \frac{D}{\left(\frac{I}{\langle K \rangle \times I_p} - C \right)^2} + \frac{E}{\left(\frac{I}{\langle K \rangle \times I_p} - C \right)^3} \right)$$

where: M = O/C CURVE MULTIPLIER setpoint, I = input current, I_p = PHASE O/C PICKUP setpoint
 A, B, C, D, E = curve constants; $A = 0.0399, B = 0.2294, C = 0.5000, D = 3.0094, E = 0.7222$
 K = voltage restrained multiplier <optional>

The voltage restrained multiplier is calculated as $K = \frac{\text{phase-to-phase voltage}}{\text{rated phase-to-phase voltage}}$ and has a range of 0.1 to 0.9.

- Using Figure 7-4: SECONDARY INJECTION TEST SETUP #3 on page 7-15, inject current and apply voltage as per the table below. Verify the alarm/trip elements and view the event records in A5 EVENT RECORD

CURRENT/VOLTAGE (5 A UNIT)		ALARM			TRIP		TRIP DELAY	
CURRENT	VOLTAGE	EXPECTED	OBSERVED	DELAY	EXPECTED	OBSERVED	EXPECTED	OBSERVED
Ian = 5 A∠0° Ibn = 5 A∠120° lag Icn = 5 A∠240° lag	Vab = 120 V∠0° lag Vbc = 120 V∠120° lag Vca = 120 V∠240° lag	✗		N/A	✗		N/A	N/A
Ian = 6 A∠0° Ibn = 6 A∠120° lag Icn = 6 A∠240° lag	Vab = 120 V∠0° Vbc = 120 V∠120° lag Vca = 120 V∠240° lag	✓			✗		N/A	N/A
Ian = 10 A∠0° Ibn = 10 A∠120° lag Icn = 10 A∠240° lag	Vab = 120 V∠0° Vbc = 120 V∠120° lag Vca = 120 V∠240° lag	✓			✓		11.8 sec.	
Ian = 10 A∠0° Ibn = 10 A∠120° lag Icn = 10 A∠240° lag	Vab = 100 V∠0° Vbc = 100 V∠120° lag Vca = 100 V∠240° lag	✓			✓		6.6 sec.	
Ian = 10 A∠0° Ibn = 10 A∠120° lag Icn = 10 A∠240° lag	Vab = 60 V∠0° Vbc = 60 V∠120° lag Vca = 60 V∠240° lag	✓			✓		1.7 sec.	

✓ activated; ✗ Not Activated

8.1.1 DESCRIPTION

This document provides all the necessary information to install and/or upgrade a previous installation of the 489PC software, upgrade the relay firmware and write/edit setpoint files.



The 489PC software is *not* compatible with Mods and could cause errors if setpoints are edited. However, it can be used to upgrade older versions of relay firmware. When doing this, previously programmed setpoints will be erased. They should be saved beforehand to a file for reprogramming with the new firmware.

The following sections are included in this chapter:

- System requirements
- 489PC software version for previous installation check
- 489PC software installation/upgrade procedure
- 489PC software system configuration
- Relay firmware upgrade procedure
- Creating/editing/upgrading/downloading setpoint files
- Printing setpoints and actual values
- Trending and waveform capture
- Troubleshooting

8.1.2 HARDWARE & SOFTWARE REQUIREMENTS

The following minimum requirements must be met for the 489PC software to properly operate on a computer.

- Processor: minimum 486, Pentium or higher recommended
- Memory: minimum 4 MB, 16 MB recommended
minimum 540K of conventional memory
- Hard Drive: 20 MB free space required before installation of software.
- O/S: Windows 3.1, Windows 3.11 for Workgroups, Windows 95/98, or Windows NT.



Windows 3.1 users must ensure that **SHARE.EXE** is installed.

489PC may be installed from either the GE Power Management Products CD or the GE Power Management website at **www.GEindustrial.com/pm**. If you are using legacy equipment without web access or a CD, 3.5" floppy disks can be ordered from the factory.

8.1.3 CHECKING IF INSTALLATION/UPGRADE IS REQUIRED

If 489PC is already installed, run the program and use the following procedure to check if it needs upgrading:

1. While 489PC is running, insert the GE Power Management Products CD and allow it to autostart (alternately, load the D:\index.htm file from the CD into your default web browser), **OR**
Go to the GE Power Management website at www.GEindustrial.com/pm (preferred method)
2. Click the “Software” menu item and select “489 Generator Management Relay” from the product list.
3. Verify that the version shown is identical to the installed version (see below). The **Help > About 489PC** menu item displays the current version of 489PC.

GE Industrial Systems

EliteNet Login | Register Now!

Site Search go

Home | Buy | Tools | Products | Services | Solutions | Support | About Us | Contact Us

Home > Products > Relays - Protective > Generator Protection (Multifunction) > 489 Generator Management Relay

Relays - Protective

489 Generator Management Relay

Back to GE PM

File Name	Title	Version	Revision Date	Manual	Release Notes
489pc150	Download 489PC Software (exe)	v1.50	01-24-2002		
32h150a8	Download firmware (zip)	v1.50 Firmware	12-19-2001		
getrade221	GE-TRADE Version 2.2.1		05-16-2000		
fwreadme	Release announcement for 489PC 1.41		05-12-2000		

Resources

- Product Information
- Brochures
- Application/Technical
- Instruction/Installation
- Specifications
- Drawings
- Presentations
- Software
- Support Documents

Buy

- Buy Online
- Where To Buy

Privacy Policy | Terms of Use | Terms of Sale © General Electric Company 1997-2002

About 489PC

489PC Version 1.50

Copyright © 2000 (GE Power Management)

OK

GE Power Management
215 Anderson Avenue
Markham, Ontario, Canada L6E 1B3
TEL: (905) 294-6222
FAX: (905) 201-2098
www.GEindustrial.com/pm

Free Resources

USER = 22%
GDI = 34%

If these two versions do not match, then the 489PC software must be upgraded.

8.1.4 INSTALLING/UPGRADING 489PC

Installation/upgrade of the 489PC software is accomplished as follows:

1. Ensure that Windows is running on the local PC
2. Insert the GE Power Management Products CD into your computer or point your web browser to the GE Power Management website at **www.GEindustrial.com/pm**. With Windows95/98, the Products CD will launch the welcome screen (see figure below) automatically; with Windows 3.1, open the Products CD by opening the `index.htm` file in the CD root directory with a web browser.

The Products CD is essentially a “snapshot” of the GE Power Management website at the date printed on the CD. As such, the procedures for installation from the CD or the website are identical; however, to ensure that the newest version of 489PC is installed, installation from the web is preferred.

Figure 8–1: GE POWER MANAGEMENT WELCOME SCREEN

3. Click the **Index by Product Name** item from the Products menu of the left side of the page then select **489 Generator Management Relay** from the product list to open the 489 product page.
4. Click the **Software** item from the **Resources** list to open the 489 software page.
5. The latest version of 489PC will be shown (see previous page). Select the **Download 489PC Software** item to download the installation program. Run the installation program and follow the prompts to install the 489PC software. When complete, a new GE Power Management group window will appear containing the 489PC icon.

8.2.1 STARTUP & COMMUNICATIONS CONFIGURATION

1. Connect the computer running the 489PC software to the relay via one of the RS485 ports (see Section 2.2.13: RS485 COMMUNICATIONS PORTS on page 2–14 for wiring diagram and additional information) or directly via the RS232 front port.
2. Start 489PC. When starting, the software attempts to communicate with the relay. If communications are established, the relay graphic shown on the monitor will display the same information as the actual relay. That is, the LED status and display information will also match that of the actual relay.
3. If 489PC cannot establish communications, the following message will appear:

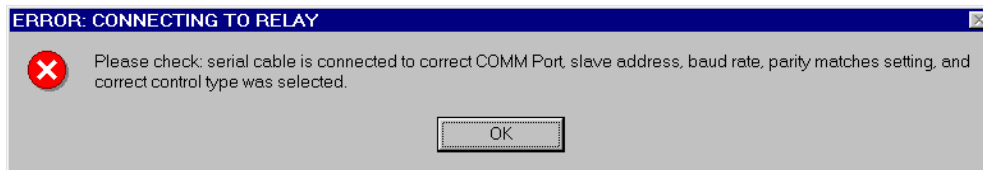

4. Select **OK** to edit the communications settings (or alternately, select the **Communications > Computer** menu item to edit communications settings at any time. The COMMUNICATIONS/COMPUTER dialog box will appear containing the various communications settings. The settings should be modified as follows:
 - set Slave Address to match the **S1 489 SETUP\SERIAL PORTS\SLAVE ADDRESS** setpoint
 - set Communication Port # to the PC port connected to the relay
 - set Baud Rate to match the **S1 489 SETUP\SERIAL PORTS\COMPUTER RS485 BAUD RATE** setpoint
 - set Parity to match the **S1 489 SETUP\SERIAL PORTS\COMPUTER RS485 PARITY** setpoint
 - set Control Type to the type used.

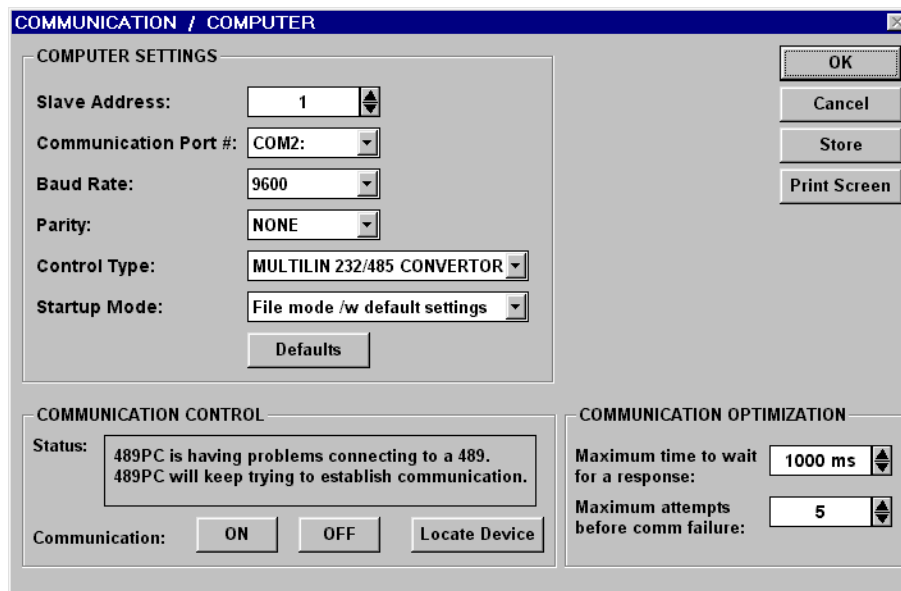

Figure 8–2: COMMUNICATION/COMPUTER DIALOG BOX

5. To begin communications, click the ON button. The status section indicates the communications status. The message “489PC is now talking to a 489” is displayed when communications are established. As well, the bottom right corner of the 489PC window will indicate “Communicating.”

8.3.1 SAVING SETPOINTS TO A FILE

Setpoints must be saved to a file on the local PC before performing any firmware upgrades. Saving setpoints is also highly recommended before making any setpoint changes or creating new setpoint files. The following procedure illustrates how to save setpoint files.

1. Select the **File > Properties** menu item. The dialog box below appears, allowing for the configuration of the 489PC software for the correct firmware version. 489PC requires the correct software version when creating a setpoint file to ensure that setpoints not available in a particular version are not downloaded into the relay.

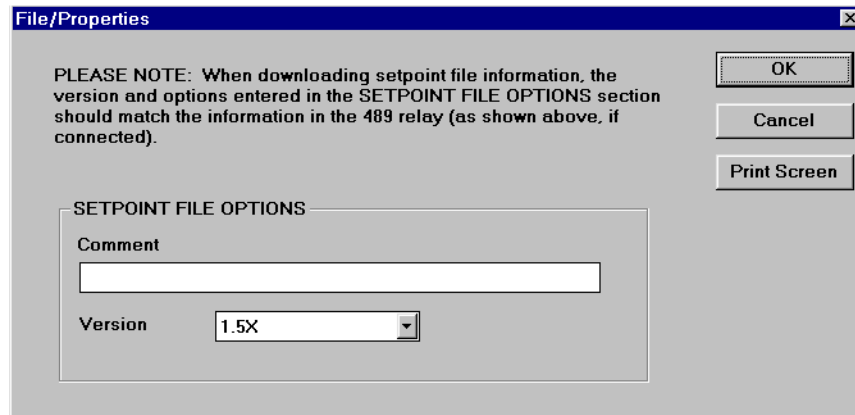

2. When the correct firmware version is chosen, select the **File > Save As** menu item. This launches the dialog box shown below. Enter or select the filename under which the setpoints are to be saved. All 489 setpoint files should have the extension 489 (for example, gen1.489). Click OK to proceed.

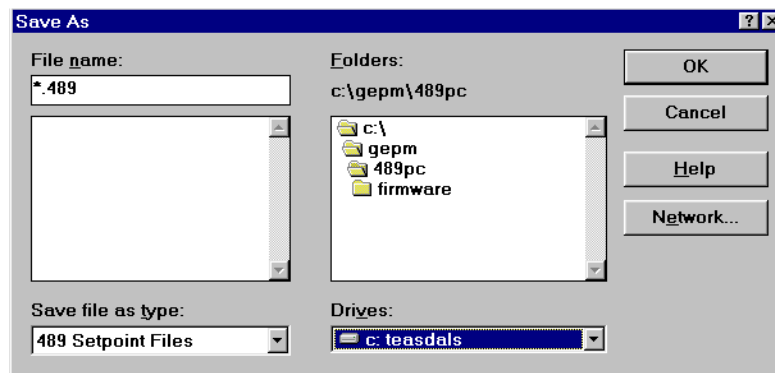

3. The software reads all relay setpoint values and stores them in the selected file.

8.3.2 UPGRADING THE 489 FIRMWARE

Prior to downloading new firmware into the 489, it is necessary to save the 489 setpoints to a file (see Section 8.3.1: SAVING SETPOINTS TO A FILE on page 8–5). Loading new firmware into the 489 flash memory is accomplished as follows:

1. Ensure the computer is connected to the 489 *via the front RS232 port* and that communications have been established. Save the current setpoints to a file using the procedure outlined in the previous section.
2. Select the **Communications > Upgrade Firmware** menu item.
3. A warning message will appear (remember that all previously programmed setpoints will be erased). Click **Yes** to proceed or **No** to exit.
4. Next, 489PC will request the name of the new firmware file. Locate the appropriate file by changing drives and/or directories until a list of names appears in the list box. 489 firmware files have the following format:

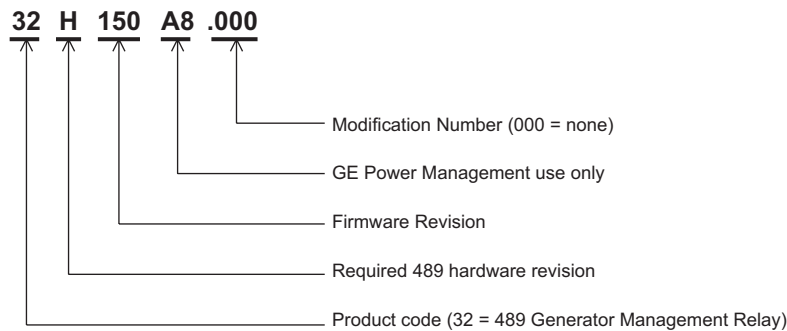

5. The 489PC software automatically lists all filenames beginning with 32. Select the appropriate file and click OK to continue.
6. 489PC prompts with the following dialog box. This will be the last chance to cancel the firmware upgrade before the flash memory is erased. Click **Yes** to continue or **No** to cancel the upgrade.

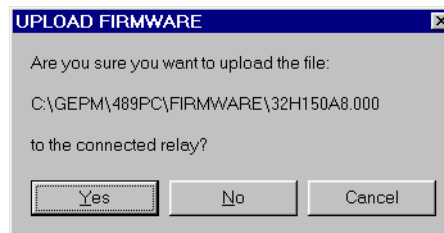

7. The software automatically puts the relay into "upload mode" and begins loading the selected firmware file. Upon completion, the relay is placed back into "normal mode".
8. When the 489 firmware update is complete, the relay will not be in service and will require programming. To communicate with the relay via the RS485 ports, the **Slave Address**, **Baud Rate**, and **Parity** will have to be manually programmed. When communications is established, the saved setpoints will have to be reloaded back into the 489. See the next section for details.

8.3.3 LOADING SETPOINTS FROM A FILE



An error message will occur when attempting to download a setpoint file with a revision number that does not match the relay firmware. If the firmware has been upgraded since saving the setpoint file, see Section 8.3.5: UPGRADING SETPOINT FILES TO NEW REVISION on page 8–9 for instructions on changing the revision number of a setpoint file.

The following procedure demonstrates how to load setpoints from a file:

1. Select the **File > Open** menu item.
2. 489PC will launch the Open window and list all filenames in the 489 default directory with the 489 extension. Select the setpoint file to download and click OK to continue.

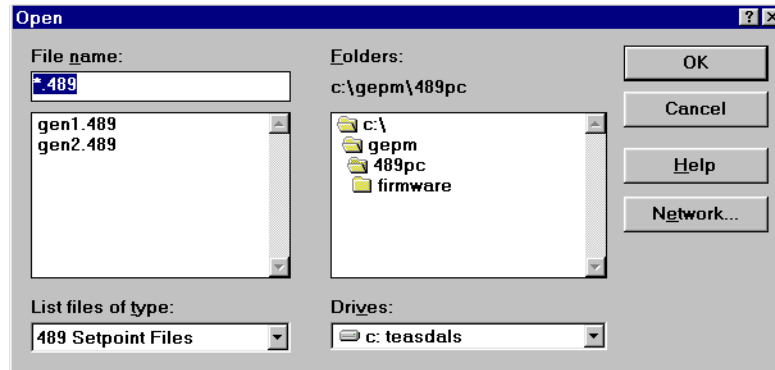

3. Select the **File > Send Info to Relay** menu item. 489PC will prompt to confirm or cancel the setpoint file load. Click Yes to update the 489 setpoints.

8.3.4 ENTERING SETPOINTS

The following example illustrates how setpoints are entered and edited with the 489PC software.

1. Select the **Setpoint > System Setup** menu item.
2. Click the **Current Sensing** tab to edit the **S2 SYSTEM SETUP\CURRENT SENSING** setpoints. 489PC displays the following window:

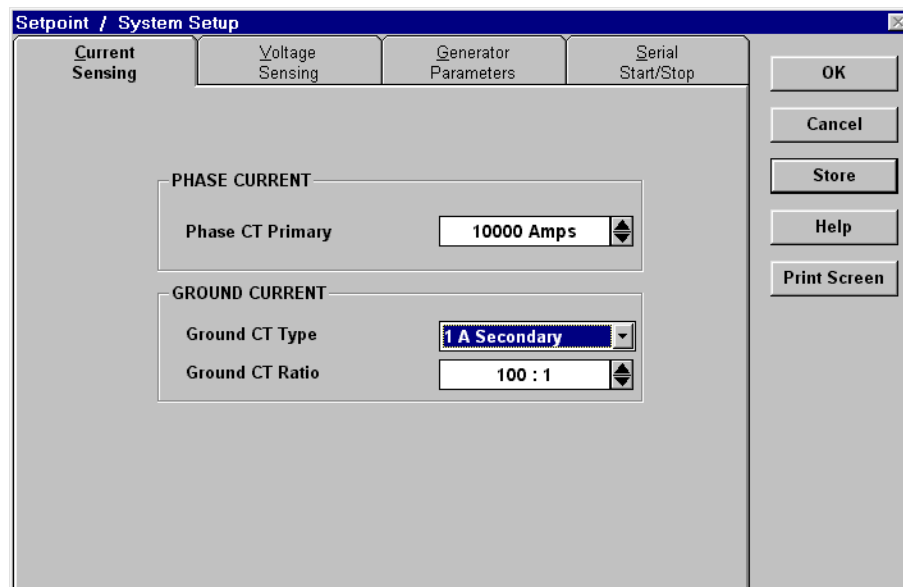

- For setpoints requiring numerical values, e.g. **PHASE CT PRIMARY**, clicking anywhere within the setpoint box launches a numerical keypad showing the old value, range, and setpoint value increment.

Enter PHASE CT PRIMARY Value

Old Value: 10000 Amps
Range: 10 TO 50000, OFF

Increment: 1

A	D	7	8	9	CE
B	E	4	5	6	
C	F	1	2	3	Off
Hex		0	+/-	.	
Dec					

- Alternately, numerical setpoint values may also be chosen by scrolling with the up/down arrow buttons at the end of the setpoint box. The values increment and decrement accordingly.
- For setpoints requiring non-numerical pre-set values (e.g. **GROUND CT TYPE** above), clicking anywhere within the setpoint value box displays a drop down selection menu.
- For setpoints requiring an alphanumeric text string (e.g. message scratchpad messages), the value may be entered directly within the setpoint value box.

8.3.5 UPGRADING SETPOINT FILES TO NEW REVISION

It may be necessary to upgrade the revision code for a previously saved setpoint file after the 489 firmware has been upgraded.

1. Establish communications with the 489 relay.
2. Select the **Actual > Product Information** menu item and record the **Flash Revision** identifier of the relay firmware. For example, 32H150A8.000, where **150** is the Flash Revision identifier and refers to firmware revision 1.50.
3. Select the **File > Open** menu item and enter the location and file name of the saved setpoint file. When the file is opened, the 489PC software will be in “File Editing” mode and “Not Communicating”.
4. Select the **File > Properties** menu item and note the version code of the setpoint file. If the **Version** code of the setpoint file (e.g. 1.5X shown below) is different than the **Flash Revision** code noted in step 2, select a **Version** code which matches the **Flash Revision** code from the pull-down menu.

For example,

If the firmware revision is: 32H150A8.000
and the current setpoint file revision is: 1.30
change the setpoint file revision to: 1.5X

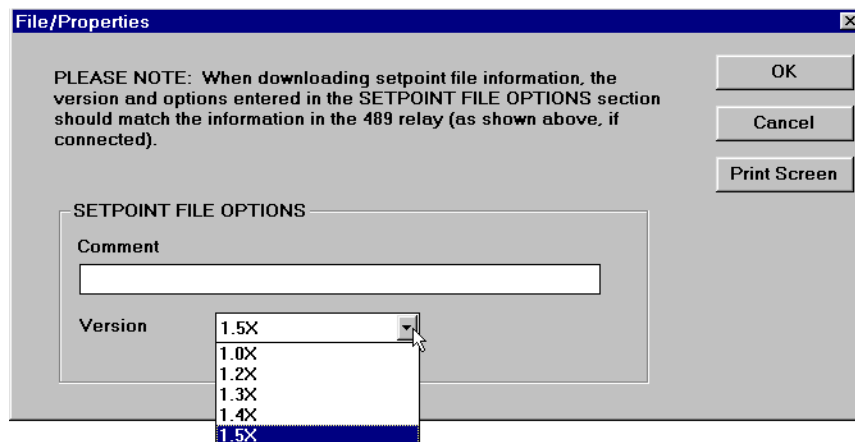

5. Select the **File > Save** menu item to save the setpoint file in the new format.
6. See Section 8.3.3: LOADING SETPOINTS FROM A FILE on page 8–7 for instructions on downloading this setpoint file to the 489.

8.3.6 PRINTING SETPOINTS & ACTUAL VALUES

a) SETPOINTS

1. Select the **File > Open** menu item and open a previously saved setpoint file OR establish communications with the 489.
2. Select the **File > Print Setup** menu item.
3. Select either **Setpoints (All)** or **Setpoints (Enabled Features)** and click **OK**.
4. Select the **File > Print** menu item to print the 489 setpoints.

b) ACTUAL VALUES

1. Establish communications with the 489.
2. Select the **File > Print Setup** menu item.
3. Select **Actual Values** and click **OK**.
4. Select the **File > Print** menu item to print the 489 actual values.

8.3.7 TRENDING

Trending from the 489 can be accomplished via the 489PC program. Many different parameters can be trended and graphed at sampling periods ranging from 1 second up to 1 hour.

The parameters which can be **Trended** by the 489PC software are:

Currents/Voltages:	Phase Currents A, B, and C	Neutral Currents A, B, and C
	Generator Load	Negative Sequence Current
	Ground Current	Differential Currents A, B, and C
	System Frequency	Voltages Vab, Vbc, Vca Van, Vbn, and Vcn
	Volts/Hz	Neutral Voltage (fundamental)
	Neutral Voltage (3 rd harmonic)	Terminal Voltage (3 rd harmonic)
Power:	Power Factor	Real Power (MW)
	Reactive Power (Mvar)	Apparent Power (MVA)
	Positive Watthours	Positive Varhours
	Negative Varhours	
Temperature:	Hottest Stator RTD	Thermal Capacity Used
	RTDs 1 through 12	
Others:	Analog Inputs 1, 2, 3, and 4	Tachometer

1. With the 489PC running and communications established, select the Actual > Trending menu item to open the trending window.
2. Click Setup to enter the Graph Attribute page.
3. Select the graphs to be displayed with the pull-down menus beside each Description. Change the Color, Style, Width, Group#, and Spline sections as desired. Select the same Group# to scale all parameters together.
4. Click Save to store the graph attributes and OK to close the window.

Graph #	Description	Color	Style	Width	Scaling Group	Use Spline
1	Demo Trending	Blue	Solid	1	Default	No
2	Ia	Green	Solid	1	1	No
3	Ib	Red	Solid	1	1	No
4	Ic	Magenta	Solid	1	1	No
5	Van	Light Blue	Solid	1	2	No
6	Vbn	Yellow	Solid	1	2	No
7	Vcn	Light Red	Solid	1	2	No
8	MW	Light Magenta	Solid	1	3	No

Figure 8-3: GRAPH ATTRIBUTE WINDOW – TRENDING

- Select the Sample Rate through the pull-down menu, click the checkboxes of the graphs to be displayed, then click RUN to begin the trending sampling.

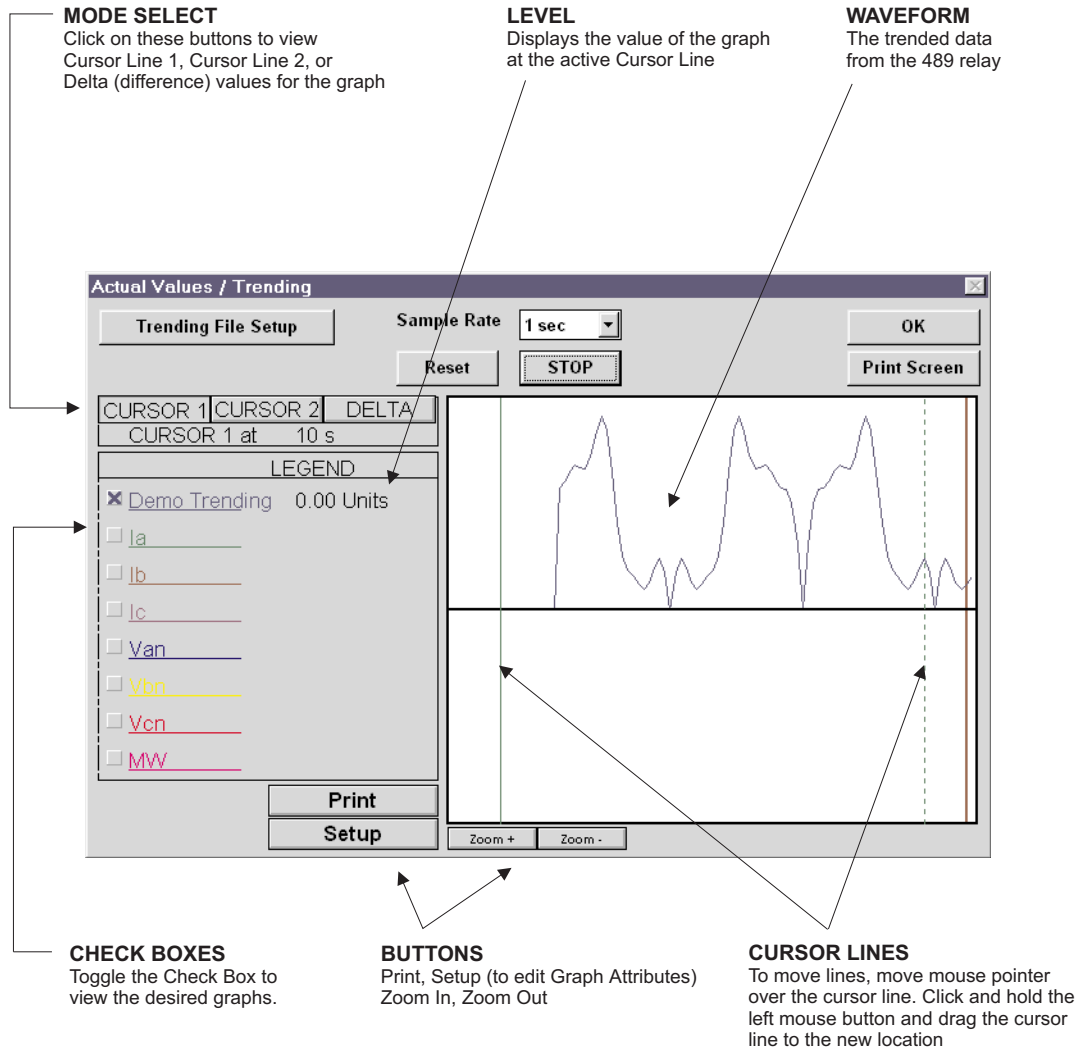

Figure 8-4: TRENDING

- The Trending File Setup button can be used to write graph data to a standard spreadsheet format. Ensure that the Write trended data to the above file checkbox is checked and that the Sample Rate is a minimum of 5 seconds.

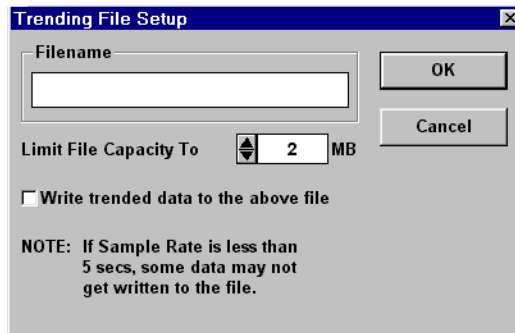

Figure 8-5: TRENDING FILE SETUP

8.3.8 WAVEFORM CAPTURE

The 489PC software can be used to capture waveforms from the 489 at the instant of a trip. A maximum of 64 cycles can be captured and the trigger point can be adjusted to anywhere within the set cycles. A maximum of 16 waveforms can be buffered (stored) with the buffer/cycle trade-off.

The waveforms captured are: Phase Currents A, B, and C; Neutral Currents A, B, and C; Ground Current; and Phase Voltages A-N, B-N, and C-N

1. With 489PC running and communications established, select the **Actual > Waveform Capture** menu item to open the waveform capture window.
2. The phase A current waveform for the last 489 trip will appear. The date and time of the trip is displayed at the top of the window. The red vertical line indicates the trigger point of the relay.
3. Press the Setup button to enter the Graph Attribute page. Program the graphs to be displayed with the pull-down menu beside each graph description. Change the Color, Style, Width, Group#, and Spline selections as desired. Select the same Group# to scale all parameters together.
4. Click Save to store these graph attributes, then click OK to close the window.
5. Select the graphs to display by checking the appropriate checkboxes.
6. The Save button stores the current image on the screen, and Open recalls a saved image. Print will copy the window to the system printer.

MODE SELECT

Click to view Cursor Lines 1, 2, or Difference (Delta) values for the graph

TRIGGER CAUSE

Displays the cause of the trigger

TRIGGER

Click to manually trigger and capture waveforms

DATE/TIME

Displays the date and time of the trigger cause

LEVEL

Displays the value of the graph at the solid cursor line

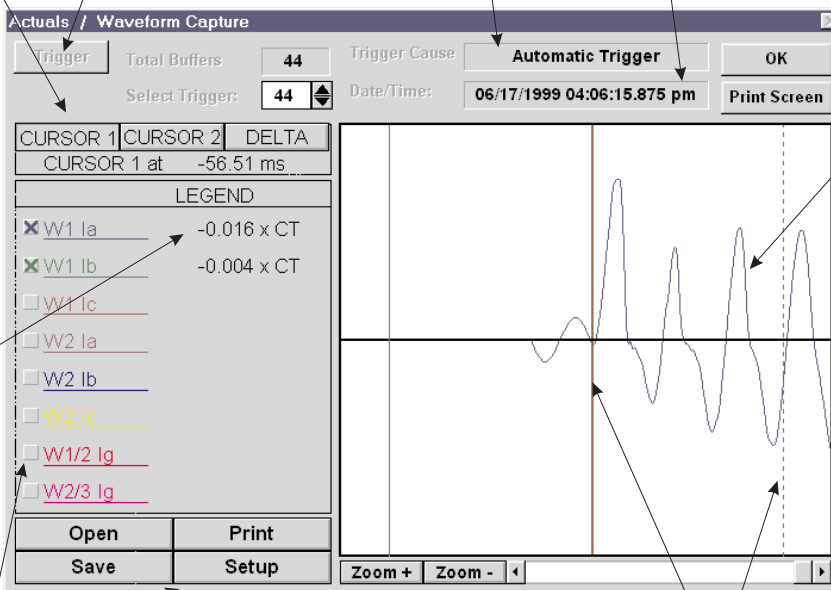
**WAVEFORM**

The 489 waveform data

CHECK BOX

Toggle the check boxes to view desired graphs

BUTTONS

Print, Help, Save (to save graph to a file), Open (to open a graph file), Zoom In and Out

CURSOR LINES

To move lines, move the mouse pointer over the cursor line; hold the left mouse button and drag the cursor line to a new location

Figure 8-6: WAVEFORM CAPTURE

8.3.9 PHASORS

The 489PC software can be used to view the phasor diagram of three phase currents and voltages. The phasors are for:

- Phase Voltages A, B, and C
- Phase Currents A, B, and C
- Impedance Z_{Loss}

1. With 489PC running and communications established, open the Metering Data window by selecting the Actual > Metering Data menu item then clicking the Phasors tab. The phasor diagram and the values of the voltage phasors are displayed.



Longer arrows are the voltage phasors, shorter arrows are the current phasors.

2. V_a and I_a are the references (i.e. zero degree phase). The lagging angle is clockwise.

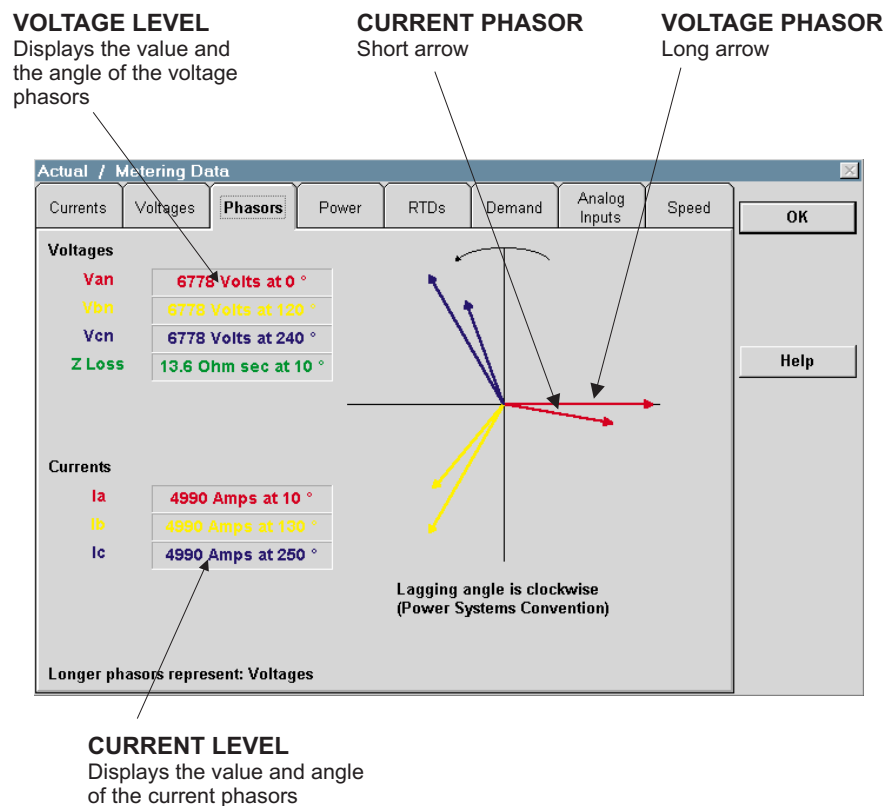

Figure 8-7: PHASORS

8.3.10 EVENT RECORDER

The 489 event recorder can be viewed through the 489PC software. The event recorder stores generator and system information each time an event occurs (e.g. a generator trip). Up to 40 events can be stored, where EVENT01 is the most recent and EVENT40 is the oldest. EVENT40 is overwritten whenever a new event occurs.

1. With 489PC running and communications established, select the **Actual > Event Recording** menu item to open the Event Recording window. This window displays the list of events with the most current event displayed first (see the figure below).
2. Press the View Data button to see details of selected events.
3. The Event Recorder Selector at the top of the View Data window scrolls through different events. Select Save to store the details of the selected events to a file.
4. Select Print to send the events to the system printer, and OK to close the window.

DISPLAY
Displays the date of last event and the total number of events since last clear

EVENT LISTING
List of events with the most recent displayed on top

VIEW DATA
Click to display the details of selected events

EVENT SELECT BUTTONS
Push the All button to select all events
Push the None button to clear all selections

CLEAR EVENTS
Click the Clear Events button to clear the Event Listing from memory

The screenshot shows a window titled "Actual Values / Event Recorder". At the top, it displays "Last Reset Date" as "June 12, 1997" and "Events Since Last Clear" as "8". Below this is a table with columns: "Select", "Event", "Date", "Time", and "Cause of Event". The table contains 8 rows of event data, with the most recent event (Event 8) at the top. At the bottom of the table are "All" and "None" buttons. To the right of the table is a vertical stack of buttons: "OK", "Save", "Print", "View Data", "Clear Events", and "Help".

Select	Event	Date	Time	Cause of Event
<input checked="" type="checkbox"/>	8	June 12, 199	05:45:06.58 pm	Simulation Start
<input checked="" type="checkbox"/>	7	June 12, 199	05:45:20.71 pm	Short Circuit Trip
<input checked="" type="checkbox"/>	6	June 12, 199	05:47:07.83 pm	Simulation Start
<input checked="" type="checkbox"/>	5	June 12, 199	05:47:32.23 pm	Overload Trip
<input checked="" type="checkbox"/>	4	June 12, 199	05:48:12.33 pm	Emergency Restart Close
<input checked="" type="checkbox"/>	3	June 12, 199	05:48:14.58 pm	Emergency Restart Open
<input checked="" type="checkbox"/>	2	June 12, 199	05:48:54.34 pm	Emergency Restart Close
<input checked="" type="checkbox"/>	1	June 12, 199	05:48:55.59 pm	Emergency Restart Open

Figure 8–8: 489PC EVENT RECORDER

8.3.11 TROUBLESHOOTING

This section provides some procedures for troubleshooting the 489PC when troubles are encountered within the Windows environment (for example, **General Protection Fault (GPF)**, **Missing Window**, **Problems in Opening/Saving Files**, and **Application Error** messages).

If the 489PC software causes Windows system errors:

1. Check system resources:
 - In Windows 95/98, right-click on the **My Computer** icon and click on the **Performance** tab.
 - In Windows 3.1/3.11, select the **Help > About Program Manager** menu item from the Program Manager window.
Verify that the available system resources are 60% or higher. If they are lower, close any other programs that are not being used.
2. The `threed.vbx` file in the Windows directory structure is used by the 489PC software (and possibly other Windows™ programs). Some older versions of this file are not compatible with 489PC; therefore it may be necessary to update this file with the latest version included with 489PC. After installation of the 489PC software, this file will be located in `\GEPM\489PC\threed.vbx`.
3. To update the `threed.vbx` file, locate the currently used file and make a backup of it, e.g. `threed.bak`.
4. A search should be conducted to locate any `threed.vbx` files on the local PC hard drive. The file which needs replacing is the one located in the `\windows` or the `\windows\system` directory.
5. Replace the original `threed.vbx` with `\GEPM\489PC\threed.vbx`. Ensure that the new file is copied to the same directory where the original one was.
6. If Windows™ prevents the replacing of this file, restart the PC and replace the file before any programs are opened.
7. Restart Windows™ for these changes to take full effect.

A.1.1 SETPOINTS SUMMARY

A

Table A-1: SETPOINTS PAGE 1 – 489 SETUP

DESCRIPTION	DEFAULT	USER VALUE
PASSCODE		
Passcode	-----	
PREFERENCES		
Default Message Cycle Time	2.0 sec.	
Default Message Timeout	300 sec.	
Parameter Avg. Calc. Period	15 min.	
Temperature Display	Celsius	
Waveform Trigger	25%	
Waveform Memory Buffer	8 × 14 cycles	
SERIAL PORTS		
Slave Address	254	
Comp. RS485 Baud Rate	9600	
Comp. RS485 Parity	None	
Aux. RS485 Baud Rate	9600	
Aux. RS485 Parity	None	
Port Used for DNP	None	
DNP Slave Address	255	
DNP Turnaround Time	10 msec.	
REAL TIME CLOCK		
IRIG-B Signal Type	None	
MESSAGE SCRATCHPAD		
Text 1		
Text 2		
Text 3		
Text 4		
Text 5		

Table A-2: SETPOINTS PAGE 2 – SYSTEM SETUP

DESCRIPTION	DEFAULT	USER VALUE
CURRENT SENSING		
Phase CT Primary	-----	
Ground CT	50:0.025	
Ground CT Ratio	100:1	
VOLTAGE SENSING		
VT Connection Type	None	
Voltage Transformer Ratio	5.00:1	
Neutral Voltage Transformer	No	
Neutral VT Ratio	5.00:1	
GENERATOR PARAMETERS		
Generator Rated MVA	-----	
Generator Rated Power Factor	-----	
Generator Voltage Ph-Ph	-----	
Generator Nominal Frequency	-----	
Generator Phase Sequence	-----	
SERIAL START/STOP		
Serial Start/Stop Initiation	Off	
Startup Initiation Relays	----	
Shutdown Initiation Relays	----	
Serial Start/Stop Events		

A

Table A-3: SETPOINTS PAGE 3 – DIGITAL INPUTS (Sheet 1 of 3)

DESCRIPTION	DEFAULT	USER VALUE
BREAKER STATUS		
Breaker Status	Auxiliary B	
GENERAL INPUT A		
Assign Digital Input	None	
Asserted Digital Input State	Closed	
Input Name	Input A	
Block Input From Online	0 sec.	
General Input A Control	Off	
Pulsed Control Relay Dwell Time	0.0 sec.	
Assign Control Relays	----	
General Input A Control Events	Off	
General Input A Alarm	Off	
Assign Alarm Relays	----	
General Input A Alarm Delay	5.0 sec.	
General Input A Alarm Events	Off	
General Input A Trip	Off	
Assign Trip Relays	----	
General Input A Trip Delay	5.0 sec.	
GENERAL INPUT B		
Assign Digital Input	None	
Asserted Digital Input State	Closed	
Input Name	Input B	
Block Input From Online	0 sec.	
General Input B Control	Off	
Pulsed Control Relay Dwell Time	0.0 sec.	
Assign Control Relays	----	
General Input B Control Events	Off	
General Input B Alarm	Off	
Assign Alarm Relays	----	
General Input B Alarm Delay	5.0 sec.	
General Input B Alarm Events	Off	
General Input B Trip	Off	
Assign Trip Relays	----	
General Input B Trip Delay	5.0 sec.	

DESCRIPTION	DEFAULT	USER VALUE
GENERAL INPUT C		
Assign Digital Input	None	
Asserted Digital Input State	Closed	
Input Name	Input C	
Block Input From Online	0 sec.	
General Input C Control	Off	
Pulsed Control Relay Dwell Time	0.0 sec.	
Assign Control Relays	----	
General Input C Control Events	Off	
General Input C Alarm	Off	
Assign Alarm Relays	----	
General Input C Alarm Delay	5.0 sec.	
General Input C Alarm Events	Off	
General Input C Trip	Off	
Assign Trip Relays	----	
General Input C Trip Delay	5.0 sec.	
GENERAL INPUT D		
Assign Digital Input	None	
Asserted Digital Input State	Closed	
Input Name	Input D	
Block Input From Online	0 sec.	
General Input D Control	Off	
Pulsed Control Relay Dwell Time	0.0 sec.	
Assign Control Relays	----	
General Input D Control Events	Off	
General Input D Alarm	Off	
Assign Alarm Relays	----	
General Input D Alarm Delay	5.0 sec.	
General Input D Alarm Events	Off	
General Input D Trip	Off	
Assign Trip Relays	----	
General Input D Trip Delay	5.0 sec.	
Assign Trip Relays		

Table A-3: SETPOINTS PAGE 3 – DIGITAL INPUTS (Sheet 2 of 3)

DESCRIPTION	DEFAULT	USER VALUE	DESCRIPTION	DEFAULT	USER VALUE
GENERAL INPUT E			GENERAL INPUT G		
Assign Digital Input	None		Assign Digital Input	None	
Asserted Digital Input State	Closed		Asserted Digital Input State	Closed	
Input Name	Input E		Input Name	Input G	
Block Input From Online	0 sec.		Block Input From Online	0 sec.	
General Input E Control	Off		General Input G Control	Off	
Pulsed Control Relay Dwell Time	0.0 sec.		Pulsed Control Relay Dwell Time	0.0 sec.	
Assign Control Relays	----		Assign Control Relays	----	
General Input E Control Events	Off		General Input G Control Events	Off	
General Input E Alarm	Off		General Input G Alarm	Off	
Assign Alarm Relays	----		Assign Alarm Relays	----	
General Input E Alarm Delay	5.0 sec.		General Input G Alarm Delay	5.0 sec.	
General Input E Alarm Events	Off		General Input G Alarm Events	Off	
General Input E Trip	Off		General Input G Trip	Off	
Assign Trip Relays	----		Assign Trip Relays	----	
General Input E Trip Delay	5.0 sec.		General Input G Trip Delay	5.0 sec.	
GENERAL INPUT F			REMOTE RESET		
Assign Digital Input	None		Assign Digital Input	None	
Asserted Digital Input State	Closed		TEST INPUT		
Input Name	Input F		Assign Digital Input	None	
Block Input From Online	0 sec.		THERMAL RESET		
General Input F Control	Off		Assign Digital Input	None	
Pulsed Control Relay Dwell Time	0.0 sec.		DUAL SETPOINTS		
Assign Control Relays	----		Assign Digital Input	None	
General Input F Control Events	Off		Activate Setpoint Group	Group 1	
General Input F Alarm	Off		Edit Setpoint Group	Group 1	
Assign Alarm Relays	----		SEQUENTIAL TRIP		
General Input F Alarm Delay	5.0 sec.		Assign Digital Input	None	
General Input F Alarm Events	Off		Sequential Trip Type	Low Fwd Pwr	
General Input F Trip	Off		Assign Trip Relays	----	
Assign Trip Relays	----		Sequential Trip Level	0.05 × Rated	
General Input F Trip Delay	5.0 sec.		Sequential Trip Delay	1.0 sec.	

A

A

Table A-3: SETPOINTS PAGE 3 – DIGITAL INPUTS (Sheet 3 of 3)

DESCRIPTION	DEFAULT	USER VALUE
FIELD-BREAKER DISCREPANCY		
Assign Digital Input	None	
Field Status Contact	Auxiliary A	
Assign Trip Relays	----	
Field-Bkr Discrep. Trip Delay	1.0 sec.	
WAVEFORM CAPTURE		
Assign Digital Input	None	
GROUND SWITCH STATUS		
Assign Digital Input	None	
Ground Switch Contact	Auxiliary A	

DESCRIPTION	DEFAULT	USER VALUE
TACHOMETER		
Assign Digital Input	None	
Rated Speed	3600 RPM	
Tachometer Alarm	Off	
Assign Alarm Relays	----	
Tachometer Alarm Speed	110% Rated	
Tachometer Alarm Delay	1 sec.	
Tachometer Alarm Events	Off	
Tachometer Trip	Off	
Assign Trip Relays	----	
Tachometer Trip Speed	110% Rated	
Tachometer Trip Delay	1 sec.	

Table A-4: SETPOINTS PAGE 4 – OUTPUT RELAYS

DESCRIPTION	DEFAULT	USER VALUE
RELAY RESET MODE		
R1 Trip	All Resets	
R2 Auxiliary	All Resets	
R3 Auxiliary	All Resets	
R4 Auxiliary	All Resets	
R5 Alarm	All Resets	
R6 Service	All Resets	

Table A-5: SETPOINTS PAGE 5 – CURRENT ELEMENTS (Sheet 1 of 7)

DESCRIPTION	DEFAULT	USER VALUE SETPOINT GROUP 1	USER VALUE SETPOINT GROUP 2
OVERCURRENT ALARM			
Overcurrent Alarm	Off		
Assign Alarm Relays	----		
Overcurrent Alarm Level	1.01 × FLA		
Overcurrent Alarm Delay	0.1 sec.		
Overcurrent Alarm Events	Off		
OFFLINE OVERCURRENT			
Offline Overcurrent Trip	Off		
Assign Trip Relays	----		
Offline Overcurrent Pickup	0.05 × CT		
Offline Overcurrent Trip Delay	5 cycles		
INADVERTENT ENERGIZATION			
Inadvertent Energization Trip	Off		
Assign Trip Relays	----		
Arming Signal	U/V and Offline		
Inadvertent Energize O/C Pickup	0.05 × CT		
Inadvertent Energize Pickup	0.50 × Rated V		
VOLTAGE RESTRAINED PHASE OVERCURRENT			
Phase Overcurrent Trip	Off		
Assign Trip Relays	----		
Enable Voltage Restraint	No		
Voltage Lower Limit	10%		
Phase Overcurrent Pickup	10.00 × CT		
Curve Shape	ANSI Extremely Inv.		
Flexcurve Trip Time at 1.03 x PU	65535 ms		
Flexcurve Trip Time at 1.05 x PU	65535 ms		
Flexcurve Trip Time at 1.10 x PU	65535 ms		
Flexcurve Trip Time at 1.20 x PU	65535 ms		
Flexcurve Trip Time at 1.30 x PU	65535 ms		
Flexcurve Trip Time at 1.40 x PU	65535 ms		
Flexcurve Trip Time at 1.50 x PU	65535 ms		
Flexcurve Trip Time at 1.60 x PU	65535 ms		
Flexcurve Trip Time at 1.70 x PU	65535 ms		
Flexcurve Trip Time at 1.80 x PU	65535 ms		
Flexcurve Trip Time at 1.90 x PU	65535 ms		
Flexcurve Trip Time at 2.00 x PU	65535 ms		
Flexcurve Trip Time at 2.10 x PU	65535 ms		
Flexcurve Trip Time at 2.20 x PU	65535 ms		
Flexcurve Trip Time at 2.30 x PU	65535 ms		

A

Table A-5: SETPOINTS PAGE 5 – CURRENT ELEMENTS (Sheet 2 of 7)

DESCRIPTION	DEFAULT	USER VALUE SETPOINT GROUP 1	USER VALUE SETPOINT GROUP 2
Flexcurve Trip Time at 2.40 x PU	65535 ms		
Flexcurve Trip Time at 2.50 x PU	65535 ms		
Flexcurve Trip Time at 2.60 x PU	65535 ms		
Flexcurve Trip Time at 2.70 x PU	65535 ms		
Flexcurve Trip Time at 2.80 x PU	65535 ms		
Flexcurve Trip Time at 2.90 x PU	65535 ms		
Flexcurve Trip Time at 3.00 x PU	65535 ms		
Flexcurve Trip Time at 3.10 x PU	65535 ms		
Flexcurve Trip Time at 3.20 x PU	65535 ms		
Flexcurve Trip Time at 3.30 x PU	65535 ms		
Flexcurve Trip Time at 3.40 x PU	65535 ms		
Flexcurve Trip Time at 3.50 x PU	65535 ms		
Flexcurve Trip Time at 3.60 x PU	65535 ms		
Flexcurve Trip Time at 3.70 x PU	65535 ms		
Flexcurve Trip Time at 3.80 x PU	65535 ms		
Flexcurve Trip Time at 3.90 x PU	65535 ms		
Flexcurve Trip Time at 4.00 x PU	65535 ms		
Flexcurve Trip Time at 4.10 x PU	65535 ms		
Flexcurve Trip Time at 4.20 x PU	65535 ms		
Flexcurve Trip Time at 4.30 x PU	65535 ms		
Flexcurve Trip Time at 4.40 x PU	65535 ms		
Flexcurve Trip Time at 4.50 x PU	65535 ms		
Flexcurve Trip Time at 4.60 x PU	65535 ms		
Flexcurve Trip Time at 4.70 x PU	65535 ms		
Flexcurve Trip Time at 4.80 x PU	65535 ms		
Flexcurve Trip Time at 4.90 x PU	65535 ms		
Flexcurve Trip Time at 5.00 x PU	65535 ms		
Flexcurve Trip Time at 5.10 x PU	65535 ms		
Flexcurve Trip Time at 5.20 x PU	65535 ms		
Flexcurve Trip Time at 5.30 x PU	65535 ms		
Flexcurve Trip Time at 5.40 x PU	65535 ms		
Flexcurve Trip Time at 5.50 x PU	65535 ms		
Flexcurve Trip Time at 5.60 x PU	65535 ms		
Flexcurve Trip Time at 5.70 x PU	65535 ms		
Flexcurve Trip Time at 5.80 x PU	65535 ms		
Flexcurve Trip Time at 5.90 x PU	65535 ms		
Flexcurve Trip Time at 6.00 x PU	65535 ms		
Flexcurve Trip Time at 6.50 x PU	65535 ms		
Flexcurve Trip Time at 7.00 x PU	65535 ms		

Table A-5: SETPOINTS PAGE 5 – CURRENT ELEMENTS (Sheet 3 of 7)

DESCRIPTION	DEFAULT	USER VALUE SETPOINT GROUP 1	USER VALUE SETPOINT GROUP 2
Flexcurve Trip Time at 7.50 x PU	65535 ms		
Flexcurve Trip Time at 8.00 x PU	65535 ms		
Flexcurve Trip Time at 8.50 x PU	65535 ms		
Flexcurve Trip Time at 9.00 x PU	65535 ms		
Flexcurve Trip Time at 9.50 x PU	65535 ms		
Flexcurve Trip Time at 10.00 x PU	65535 ms		
Flexcurve Trip Time at 10.50 x PU	65535 ms		
Flexcurve Trip Time at 11.00 x PU	65535 ms		
Flexcurve Trip Time at 11.50 x PU	65535 ms		
Flexcurve Trip Time at 12.00 x PU	65535 ms		
Flexcurve Trip Time at 12.50 x PU	65535 ms		
Flexcurve Trip Time at 13.00 x PU	65535 ms		
Flexcurve Trip Time at 13.50 x PU	65535 ms		
Flexcurve Trip Time at 14.00 x PU	65535 ms		
Flexcurve Trip Time at 14.50 x PU	65535 ms		
Flexcurve Trip Time at 15.00 x PU	65535 ms		
Flexcurve Trip Time at 15.50 x PU	65535 ms		
Flexcurve Trip Time at 16.00 x PU	65535 ms		
Flexcurve Trip Time at 16.50 x PU	65535 ms		
Flexcurve Trip Time at 17.00 x PU	65535 ms		
Flexcurve Trip Time at 17.50 x PU	65535 ms		
Flexcurve Trip Time at 18.00 x PU	65535 ms		
Flexcurve Trip Time at 18.50 x PU	65535 ms		
Flexcurve Trip Time at 19.00 x PU	65535 ms		
Flexcurve Trip Time at 19.50 x PU	65535 ms		
Flexcurve Trip Time at 20.00 x PU	65535 ms		
Overcurrent Curve Multiplier	1.00		
Overcurrent Curve Reset	Instantaneous		

A

A

Table A-5: SETPOINTS PAGE 5 – CURRENT ELEMENTS (Sheet 4 of 7)

DESCRIPTION	DEFAULT	USER VALUE SETPOINT GROUP 1	USER VALUE SETPOINT GROUP 2
NEGATIVE SEQUENCE OVERCURRENT			
Negative Sequence Alarm	Off		
Assign Alarm Relays	---5		
Negative Sequence Alarm Pickup	3% FLA		
Negative Sequence Alarm Delay	5.0 sec.		
Negative Sequence Alarm Events	Off		
Negative Sequence O/C Trip	Off		
Assign Trip Relays	1---		
Neg. Sequence O/C Trip Pickup	8% FLA		
Neg. Sequence O/C Constant K	1		
Neg. Sequence O/C Max. Time	1000 sec.		
Neg. Sequence O/C Reset Rate	227.0 sec.		
GROUND OVERCURRENT			
Ground Overcurrent Alarm	Off		
Assign Alarm Relays	---5		
Ground Overcurrent Alarm Pickup	0.20 × CT		
Ground Overcurrent Alarm Delay	0 cycles		
Ground Overcurrent Alarm Events	Off		
Ground Overcurrent Trip	Off		
Assign Trip Relays	1---		
Ground Overcurrent Trip Pickup	0.20 × CT		
Curve Shape	ANSI Extremely Inv.		
Neg. Sequence O/C Max. Time	1000 sec.		
Neg. Sequence O/C Reset Rate	227.0 sec.		
Flexcurve Trip Time at 1.03 x PU	65535 ms		
Flexcurve Trip Time at 1.05 x PU	65535 ms		
Flexcurve Trip Time at 1.10 x PU	65535 ms		
Flexcurve Trip Time at 1.20 x PU	65535 ms		
Flexcurve Trip Time at 1.30 x PU	65535 ms		
Flexcurve Trip Time at 1.40 x PU	65535 ms		
Flexcurve Trip Time at 1.50 x PU	65535 ms		
Flexcurve Trip Time at 1.60 x PU	65535 ms		
Flexcurve Trip Time at 1.70 x PU	65535 ms		
Flexcurve Trip Time at 1.80 x PU	65535 ms		
Flexcurve Trip Time at 1.90 x PU	65535 ms		
Flexcurve Trip Time at 2.00 x PU	65535 ms		
Flexcurve Trip Time at 2.10 x PU	65535 ms		
Flexcurve Trip Time at 2.20 x PU	65535 ms		
Flexcurve Trip Time at 2.30 x PU	65535 ms		

Table A-5: SETPOINTS PAGE 5 – CURRENT ELEMENTS (Sheet 5 of 7)

DESCRIPTION	DEFAULT	USER VALUE SETPOINT GROUP 1	USER VALUE SETPOINT GROUP 2
Flexcurve Trip Time at 2.40 x PU	65535 ms		
Flexcurve Trip Time at 2.50 x PU	65535 ms		
Flexcurve Trip Time at 2.60 x PU	65535 ms		
Flexcurve Trip Time at 2.70 x PU	65535 ms		
Flexcurve Trip Time at 2.80 x PU	65535 ms		
Flexcurve Trip Time at 2.90 x PU	65535 ms		
Flexcurve Trip Time at 3.00 x PU	65535 ms		
Flexcurve Trip Time at 3.10 x PU	65535 ms		
Flexcurve Trip Time at 3.20 x PU	65535 ms		
Flexcurve Trip Time at 3.30 x PU	65535 ms		
Flexcurve Trip Time at 3.40 x PU	65535 ms		
Flexcurve Trip Time at 3.50 x PU	65535 ms		
Flexcurve Trip Time at 3.60 x PU	65535 ms		
Flexcurve Trip Time at 3.70 x PU	65535 ms		
Flexcurve Trip Time at 3.80 x PU	65535 ms		
Flexcurve Trip Time at 3.90 x PU	65535 ms		
Flexcurve Trip Time at 4.00 x PU	65535 ms		
Flexcurve Trip Time at 4.10 x PU	65535 ms		
Flexcurve Trip Time at 4.20 x PU	65535 ms		
Flexcurve Trip Time at 4.30 x PU	65535 ms		
Flexcurve Trip Time at 4.40 x PU	65535 ms		
Flexcurve Trip Time at 4.50 x PU	65535 ms		
Flexcurve Trip Time at 4.60 x PU	65535 ms		
Flexcurve Trip Time at 4.70 x PU	65535 ms		
Flexcurve Trip Time at 4.80 x PU	65535 ms		
Flexcurve Trip Time at 4.90 x PU	65535 ms		
Flexcurve Trip Time at 5.00 x PU	65535 ms		
Flexcurve Trip Time at 5.10 x PU	65535 ms		
Flexcurve Trip Time at 5.20 x PU	65535 ms		
Flexcurve Trip Time at 5.30 x PU	65535 ms		
Flexcurve Trip Time at 5.40 x PU	65535 ms		
Flexcurve Trip Time at 5.50 x PU	65535 ms		
Flexcurve Trip Time at 5.60 x PU	65535 ms		
Flexcurve Trip Time at 5.70 x PU	65535 ms		
Flexcurve Trip Time at 5.80 x PU	65535 ms		
Flexcurve Trip Time at 5.90 x PU	65535 ms		
Flexcurve Trip Time at 6.00 x PU	65535 ms		
Flexcurve Trip Time at 6.50 x PU	65535 ms		
Flexcurve Trip Time at 7.00 x PU	65535 ms		

A

Table A-5: SETPOINTS PAGE 5 – CURRENT ELEMENTS (Sheet 6 of 7)

DESCRIPTION	DEFAULT	USER VALUE SETPOINT GROUP 1	USER VALUE SETPOINT GROUP 2
Flexcurve Trip Time at 7.50 x PU	65535 ms		
Flexcurve Trip Time at 8.00 x PU	65535 ms		
Flexcurve Trip Time at 8.50 x PU	65535 ms		
Flexcurve Trip Time at 9.00 x PU	65535 ms		
Flexcurve Trip Time at 9.50 x PU	65535 ms		
Flexcurve Trip Time at 10.00 x PU	65535 ms		
Flexcurve Trip Time at 10.50 x PU	65535 ms		
Flexcurve Trip Time at 11.00 x PU	65535 ms		
Flexcurve Trip Time at 11.50 x PU	65535 ms		
Flexcurve Trip Time at 12.00 x PU	65535 ms		
Flexcurve Trip Time at 12.50 x PU	65535 ms		
Flexcurve Trip Time at 13.00 x PU	65535 ms		
Flexcurve Trip Time at 13.50 x PU	65535 ms		
Flexcurve Trip Time at 14.00 x PU	65535 ms		
Flexcurve Trip Time at 14.50 x PU	65535 ms		
Flexcurve Trip Time at 15.00 x PU	65535 ms		
Flexcurve Trip Time at 15.50 x PU	65535 ms		
Flexcurve Trip Time at 16.00 x PU	65535 ms		
Flexcurve Trip Time at 16.50 x PU	65535 ms		
Flexcurve Trip Time at 17.00 x PU	65535 ms		
Flexcurve Trip Time at 17.50 x PU	65535 ms		
Flexcurve Trip Time at 18.00 x PU	65535 ms		
Flexcurve Trip Time at 18.50 x PU	65535 ms		
Flexcurve Trip Time at 19.00 x PU	65535 ms		
Flexcurve Trip Time at 19.50 x PU	65535 ms		
Flexcurve Trip Time at 20.00 x PU	65535 ms		
Overcurrent Curve Multiplier	1.00		
Overcurrent Curve Reset	Instantaneous		

Table A-5: SETPOINTS PAGE 5 – CURRENT ELEMENTS (Sheet 7 of 7)

DESCRIPTION	DEFAULT	USER VALUE SETPOINT GROUP 1	USER VALUE SETPOINT GROUP 2
PHASE DIFFERENTIAL			
Phase Differential Trip	Off		
Assign Trip Relays	1---		
Differential Trip Min. Pickup	$0.10 \times CT$		
Differential Trip Slope 1	10%		
Differential Trip Slope 2	20%		
Differential Trip Delay	0 cycles		
Assign Trip Relays	1---		
GROUND DIRECTIONAL			
Supervise With Digital Input	Yes		
Ground Directional MTA	0°		
Ground Directional Alarm	Off		
Assign Alarm Relays	---5		
Ground Directional Alarm Pickup	$0.05 \times CT$		
Ground Directional Alarm Delay	3.0 sec.		
Ground Directional Alarm Events	Off		
Ground Directional Trip	Off		
Assign Trip Relays	1---		
Ground Directional Trip Pickup	$0.05 \times CT$		
Ground Directional Trip Delay	3.0 sec.		
HIGH-SET PHASE OVERCURRENT			
High-Set Phase Overcurrent Trip	Off		
Assign Trip Relays	1---		
High-Set Phase O/C Pickup	$5.00 \times CT$		
High-Set Phase O/C Delay	1.00 sec.		

A

Table A-6: SETPOINTS PAGE 6 – VOLTAGE ELEMENTS (Sheet 1 of 3)

DESCRIPTION	DEFAULT	USER VALUE SETPOINT GROUP 1	USER VALUE SETPOINT GROUP 2
UNDERVOLTAGE			
Undervoltage Alarm	Off		
Assign Alarm Relays	---5		
Undervoltage Alarm Pickup	$0.85 \times \text{Rated}$		
Undervoltage Alarm Delay	3.0 sec.		
Undervoltage Alarm Events	Off		
Undervoltage Trip	Off		
Assign Trip Relays	1---		
Undervoltage Trip Pickup	$0.80 \times \text{Rated}$		
Undervoltage Trip Delay	1.0 sec.		
Undervoltage Curve Reset Rate	1.4 sec.		
Undervoltage Trip Element	Curve		
OVERVOLTAGE			
Overtoltage Alarm	Off		
Assign Alarm Relays	---5		
Overtoltage Alarm Pickup	$1.15 \times \text{Rated}$		
Overtoltage Alarm Delay	3.0 sec.		
Overtoltage Alarm Events	Off		
Overtoltage Trip	Off		
Assign Trip Relays	1---		
Overtoltage Trip Pickup	$1.20 \times \text{Rated}$		
Overtoltage Trip Delay	1.0 sec.		
Overtoltage Curve Reset Rate	1.4 sec.		
Overtoltage Trip Element	Curve		
VOLTS/HERTZ			
Volts/Hertz Alarm	Off		
Assign Alarm Relays	---5		
Volts/Hertz Alarm Pickup	$1.00 \times \text{Nominal}$		
Volts/Hertz Alarm Delay	3.0 sec.		
Volts/Hertz Alarm Events	Off		
Volts/Hertz Trip	Off		
Assign Trip Relays	1---		
Volts/Hertz Trip Pickup	$1.00 \times \text{Nominal}$		
Volts/Hertz Trip Delay	1.0 sec.		
Volts/Hertz Curve Reset Rate	1.4 sec.		
Volts/Hertz Trip Element	Curve #1		
UNDERFREQUENCY			
Block Underfrequency From Online	1.0 sec		
Voltage Level Cutoff	$0.50 \times \text{Rated}$		

Table A-6: SETPOINTS PAGE 6 – VOLTAGE ELEMENTS (Sheet 2 of 3)

DESCRIPTION	DEFAULT	USER VALUE SETPOINT GROUP 1	USER VALUE SETPOINT GROUP 2
Underfrequency Alarm	Off		
Assign Alarm Relays	---5		
Underfrequency Alarm Level	59.50 Hz		
Underfrequency Alarm Delay	5.0 sec.		
Underfrequency Alarm Events	Off		
Underfrequency Trip	Off		
Assign Trip Relays	1---		
Underfrequency Trip Level1	59.50 Hz		
Underfrequency Trip Delay1	60.0 sec.		
Underfrequency Trip Level2	58.00 Hz		
Underfrequency Trip Delay2	30.0 sec.		
OVERFREQUENCY			
Block Overfrequency From Online	1.0 sec		
Voltage Level Cutoff	0.50 × Rated		
Overfrequency Alarm	Off		
Assign Alarm Relays	---5		
Overfrequency Alarm Level	60.50 Hz		
Overfrequency Alarm Delay	5.0 sec.		
Overfrequency Alarm Events	Off		
Overfrequency Trip	Off		
Assign Trip Relays	1---		
Overfrequency Trip Level1	60.50 Hz		
Overfrequency Trip Delay1	60.0 sec.		
Overfrequency Trip Level2	62.00 Hz		
Overfrequency Trip Delay2	30.0 sec.		
NEUTRAL OVERVOLTAGE			
Supervise With Digital Input	No		
Neutral Overvoltage Alarm	Off		
Assign Alarm Relays	---5		
Neutral Overvoltage Alarm Level	3.0 Vsec.		
Neutral Overvoltage Alarm Delay	1.0 sec.		
Neutral Overvoltage Alarm Events	Off		
Neutral Overvoltage Trip	Off		
Assign Trip Relays	1---		
Neutral Overvoltage Trip Level	5.0 Vsec.		
Neutral Overvoltage Trip Delay	1.0 sec.		
Neutral O/V Curve Reset Rate	0.0		
Neutral Overvoltage Trip Element	Definite Time		

A

Table A-6: SETPOINTS PAGE 6 – VOLTAGE ELEMENTS (Sheet 3 of 3)

DESCRIPTION	DEFAULT	USER VALUE SETPOINT GROUP 1	USER VALUE SETPOINT GROUP 2
NEUTRAL UNDERVOLTAGE (3RD HARMONIC)			
Low Power Blocking Level	0.05 × Rated MW		
Low Voltage Blocking Level	0.75 × Rated		
Neutral Undervoltage Alarm	Off		
Assign Alarm Relays	---5		
Neutral Undervoltage Alarm Level	0.5 Vsec.		
Neutral Undervoltage Alarm Delay	30.0 sec.		
Neutral Undervoltage Alarm Events	Off		
Neutral Undervoltage Trip	Off		
Assign Trip Relays	1---		
Neutral Undervoltage Trip Level	1.0 Vsec.		
Neutral Undervoltage Trip Delay	30.0 sec.		
LOSS OF EXCITATION			
Enable Voltage Supervision	Yes		
Voltage Level	0.70 × Rated		
Circle 1 Trip	Off		
Assign Circle 1 Trip Relays	1---		
Circle 1 Diameter	25.0 Ωsec.		
Circle 1 Offset	2.5 Ωsec.		
Circle 1 Trip Delay	5.0 sec.		
Circle 2 Trip	Off		
Assign Circle 2 Trip Relays	1---		
Circle 2 Diameter	35.0 Ωsec.		
Circle 2 Offset	2.5 Ωsec.		
Circle 2 Trip Delay	5.0 sec.		
DISTANCE ELEMENTS			
Step Up Transformer Setup	None		
Fuse Failure Supervision	On		
Zone #1 Trip	Off		
Assign Zone #1 Trip Relays	1---		
Zone #1 Reach	10.0 Ωsec.		
Zone #1 Angel	75°		
Zone #1 Trip Delay	0.4 sec.		
Zone #2 Trip	Off		
Assign Zone #2 Trip Relays	1---		
Zone #2 Reach	15.0 Ωsec.		
Zone #2 Angle	75°		
Zone #2 Trip Delay	2.0 sec.		

Table A-7: SETPOINTS PAGE 7 – POWER ELEMENTS

DESCRIPTION	DEFAULT	USER VALUE SETPOINT GROUP 1	USER VALUE SETPOINT GROUP 2
REACTIVE POWER			
Block Mvar Element From Online	1 sec.		
Reactive Power Alarm	Off		
Assign Alarm Relays	---5		
Positive Mvar Alarm Level	0.85 × Rated		
Negative Mvar Alarm Level	0.85 × Rated		
Positive Mvar Alarm Delay	10.0 sec.		
Negative Mvar Alarm Delay	10.0 sec.		
Reactive Power Alarm Events	Off		
Reactive Power Trip	Off		
Assign Trip Relays	1---		
Positive Mvar Trip Level	0.80 × Rated		
Negative Mvar Trip Level	0.80 × Rated		
Positive Mvar Trip Delay	20.0 sec.		
Negative Mvar Trip Delay	20.0 sec.		
REVERSE POWER			
Block Reverse Power From Online	1 sec.		
Reverse Power Alarm	Off		
Assign Alarm Relays	---5		
Reverse Power Alarm Level	0.05 × Rated MW		
Reverse Power Alarm Delay	10.0 sec.		
Reverse Power Alarm Events	Off		
Reverse Power Trip	Off		
Assign Trip Relays	1---		
Reverse Power Trip Level	0.05 × Rated MW		
Reverse Power Trip Delay	20.0 sec.		
LOW FORWARD POWER			
Block Low Fwd Power From Online	0 sec.		
Low Forward Power Alarm	Off		
Assign Alarm Relays	---5		
Low Forward Power Alarm Level	0.05 × Rated MW		
Low Forward Power Alarm Delay	10.0 sec.		
Low Forward Power Alarm Events	Off		
Low Forward Power Trip	Off		
Assign Trip Relays	1---		
Low Forward Power Trip Level	0.05 × Rated MW		
Low Forward Power Trip Delay	20.0 sec.		

A

Table A-8: SETPOINTS PAGE 8 – RTD TEMPERATURE (SETPOINT GROUP 1)

DESCRIPTION	DEFAULT	USER VALUE
RTD TYPES		
Stator RTD Type	100 Ω Platinum	
Bearing RTD Type	100 Ω Platinum	
Ambient RTD Type	100 Ω Platinum	
Other RTD Type	100 Ω Platinum	
OPEN RTD SENSOR		
Open RTD Sensor Alarm	Off	
Assign Alarm Relays	---5	
Open RTD Sensor Alarm Events	Off	

DESCRIPTION	DEFAULT	USER VALUE
RTD SHORT/LOW TEMP.		
RTD Short/Low Temp Alarm	Off	
Assign Alarm Relays	---5	
RTD Short/Low Temp. Alm Events	Off	

RTD	APPLICATION	NAME	ALARM	ASSIGN ALARM RELAYS	ALARM TEMPERATURE	ALARM EVENTS
1						
2						
3						
4						
5						
6						
7						
8						
9						
10						
11						
12						

RTD	TRIP	TRIP VOTING	ASSIGN TRIP RELAYS	TRIP TEMPERATURE
1				
2				
3				
4				
5				
6				
7				
8				
9				
10				
11				
12				

Table A-9: SETPOINTS PAGE 8 – RTD TEMPERATURE (SETPOINT GROUP 2)

DESCRIPTION	DEFAULT	USER VALUE	DESCRIPTION	DEFAULT	USER VALUE
RTD TYPES			RTD SHORT/LOW TEMP.		
Stator RTD Type	100 Ω Platinum		RTD Short/Low Temp Alarm	Off	
Bearing RTD Type	100 Ω Platinum		Assign Alarm Relays	---5	
Ambient RTD Type	100 Ω Platinum		RTD Short/Low Tmp. Alm Events	Off	
Other RTD Type	100 Ω Platinum				
OPEN RTD SENSOR					
Open RTD Sensor Alarm	Off				
Assign Alarm Relays	---5				
Open RTD Sensor Alarm Events	Off				

RTD	APPLICATION	NAME	ALARM	ASSIGN ALARM RELAYS	ALARM TEMPERATURE	ALARM EVENTS
1						
2						
3						
4						
5						
6						
7						
8						
9						
10						
11						
12						

RTD	TRIP	TRIP VOTING	ASSIGN TRIP RELAYS	TRIP TEMPERATURE
1				
2				
3				
4				
5				
6				
7				
8				
9				
10				
11				
12				

A

Table A-10: SETPOINTS PAGE 9 – THERMAL MODEL (Sheet 1 of 2)

DESCRIPTION	DEFAULT	USER VALUE SETPOINT GROUP 1	USER VALUE SETPOINT GROUP 2
THERMAL MODEL SETUP			
Enable Thermal Model	No		
Overload Pickup Level	1.01 × FLA		
Unbalance Bias K Factor	0		
Cool Time Constant Online	15 min.		
Cool Time Constant Offline	30 min.		
Hot/Cold Safe Stall Ratio	1.00		
Enable RTD Biasing	No		
RTD Bias Minimum	40°C		
RTD Bias Center Point	130°C		
RTD Bias Maximum	155°C		
Select Curve Style	Standard		
Standard Overload Curve Number	4		
Time to Trip at 1.01 × FLA	65535 ms		
Time to Trip at 1.05 × FLA	65535 ms		
Time to Trip at 1.10 × FLA	65535 ms		
Time to Trip at 1.20 × FLA	65535 ms		
Time to Trip at 1.30 × FLA	65535 ms		
Time to Trip at 1.40 × FLA	65535 ms		
Time to Trip at 1.50 × FLA	65535 ms		
Time to Trip at 1.75 × FLA	65535 ms		
Time to Trip at 2.00 × FLA	65535 ms		
Time to Trip at 2.25 × FLA	65535 ms		
Time to Trip at 2.50 × FLA	65535 ms		
Time to Trip at 2.75 × FLA	65535 ms		
Time to Trip at 3.00 × FLA	65535 ms		
Time to Trip at 3.25 × FLA	65535 ms		
Time to Trip at 3.50 × FLA	65535 ms		
Time to Trip at 3.75 × FLA	65535 ms		
Time to Trip at 4.00 × FLA	65535 ms		
Time to Trip at 4.25 × FLA	65535 ms		
Time to Trip at 4.50 × FLA	65535 ms		
Time to Trip at 4.75 × FLA	65535 ms		
Time to Trip at 5.00 × FLA	65535 ms		
Time to Trip at 5.50 × FLA	65535 ms		
Time to Trip at 6.00 × FLA	65535 ms		
Time to Trip at 6.50 × FLA	65535 ms		
Time to Trip at 7.00 × FLA	65535 ms		
Time to Trip at 7.50 × FLA	65535 ms		

Table A-10: SETPOINTS PAGE 9 – THERMAL MODEL (Sheet 2 of 2)

DESCRIPTION	DEFAULT	USER VALUE SETPOINT GROUP 1	USER VALUE SETPOINT GROUP 2
Time to Trip at 8.00 × FLA	65535 ms		
Time to Trip at 10.00 × FLA	65535 ms		
Time to Trip at 15.00 × FLA	65535 ms		
Time to Trip at 20.00 × FLA	65535 ms		
Minimum Allowable Voltage	80%		
Stall Current @ Minimum Voltage	4.80 × FLA		
Safe Stall Time @ Min Voltage	20.0 sec.		
Acceleration Intersect @ Min Volt	3.80 × FLA		
Stall Current @ 100% Voltage	6.00 × FLA		
Safe Stall Time @ 100% Voltage	10.0 sec.		
Accel. Intersect @ 100% Voltage	5.00 × FLA		
THERMAL ELEMENTS			
Thermal Model Alarm	Off		
Assign Alarm Relays	---5		
Thermal Alarm Level	75% Used		
Thermal Model Alarm Events	Off		
Thermal Model Trip	Off		
Assign Trip Relays	1---		

A

A

Table A-11: SETPOINTS PAGE 10 – MONITORING

DESCRIPTION	DEFAULT	USER VALUE
TRIP COUNTER		
Trip Counter Alarm	Off	
Assign Alarm Relays	---5	
Trip Counter Alarm Level	25 Trips	
Trip Counter Alarm Events	Off	
BREAKER FAILURE		
Breaker Failure Alarm	Off	
Assign Alarm Relays	---5	
Breaker Failure Level	1.00 × CT	
Breaker Failure Delay	100 ms	
Breaker Failure Alarm Events	Off	
TRIP COIL MONITOR		
Trip Coil Monitor Alarm	Off	
Assign Alarm Relays	---5	
Supervision of Trip Coil	52 Closed	
Trip Coil Monitor Alarm Events	Off	
VOLTAGE TRANSFORMER FUSE FAILURE		
VT Fuse Failure Alarm	Off	
Assign Alarm Relays	---5	
VT Fuse Failure Alarm Events	Off	
CURRENT DEMAND		
Current Demand Period	15 min.	
Current Demand Alarm	Off	
Assign Alarm Relays	---5	
Current Demand Limit	1.25 × FLA	
Current Demand Alarm Events	Off	
MW DEMAND		
MW Demand Period	15 min.	
MW Demand Alarm	Off	
Assign Alarm Relays	---5	
MW Demand Limit	1.25 × Rated	
MW Demand Alarm Events	Off	

DESCRIPTION	DEFAULT	USER VALUE
Mvar DEMAND		
Mvar Demand Period	15 min.	
Mvar Demand Alarm	Off	
Assign Alarm Relays	---5	
Mvar Demand Limit	1.25 × Rated	
Mvar Demand Alarm Events	Off	
MVA DEMAND		
MVA Demand Period	15 min.	
MVA Demand Alarm	Off	
Assign Alarm Relays	---5	
MVA Demand Limit	1.25 × Rated	
MVA Demand Alarm Events	Off	
PULSE OUTPUT		
Positive kWh Pulse Out Relays	----	
Positive kWh Pulse Out Interval	10 kWh	
Positive kvarh Pulse Out Relays	----	
Positive kvarh Pulse Out Interval	10 kvarh	
Negative kvarh Pulse Out Relays	----	
Negative kvarh Pulse Out Interval	10 kvarh	
Pulse Width	200 ms	
GENERATOR RUNNING HOUR SETUP		
Initial Gen. Running Hours	0 hrs.	
Generator Running Hours Alarm	Off	
Assign Alarm Relays	---5	
Generator Running Hours Limit	1000 hrs	

Table A-12: SETPOINTS PAGE 11 – ANALOG INPUT/OUTPUT

DESCRIPTION	DEFAULT	USER VALUE	DESCRIPTION	DEFAULT	USER VALUE
ANALOG OUTPUT 1			ANALOG OUTPUT 3		
Setup			Setup		
Minimum			Minimum		
Maximum			Maximum		
ANALOG OUTPUT 2			ANALOG OUTPUT 4		
Setup			Setup		
Minimum			Minimum		
Maximum			Maximum		

SETPOINT	ANALOG INPUT 1	ANALOG INPUT 2	ANALOG INPUT 3	ANALOG INPUT 4
Setup				
Name				
Units				
Minimum				
Maximum				
Block From Online				
Alarm				
Assign Alarm Relays				
Alarm Level				
Alarm Pickup				
Alarm Delay				
Alarm Events				
Trip				
Assign Trip Relays				
Trip Level				
Trip Pickup				
Trip Delay				

A

A.1.1 SETPOINTS SUMMARY

A

Table A-1: SETPOINTS PAGE 1 – 489 SETUP

DESCRIPTION	DEFAULT	USER VALUE
PASSCODE		
Passcode	-----	
PREFERENCES		
Default Message Cycle Time	2.0 sec.	
Default Message Timeout	300 sec.	
Parameter Avg. Calc. Period	15 min.	
Temperature Display	Celsius	
Waveform Trigger	25%	
Waveform Memory Buffer	8 × 14 cycles	
SERIAL PORTS		
Slave Address	254	
Comp. RS485 Baud Rate	9600	
Comp. RS485 Parity	None	
Aux. RS485 Baud Rate	9600	
Aux. RS485 Parity	None	
Port Used for DNP	None	
DNP Slave Address	255	
DNP Turnaround Time	10 msec.	
REAL TIME CLOCK		
IRIG-B Signal Type	None	
MESSAGE SCRATCHPAD		
Text 1		
Text 2		
Text 3		
Text 4		
Text 5		

Table A-2: SETPOINTS PAGE 2 – SYSTEM SETUP

DESCRIPTION	DEFAULT	USER VALUE
CURRENT SENSING		
Phase CT Primary	-----	
Ground CT	50:0.025	
Ground CT Ratio	100:1	
VOLTAGE SENSING		
VT Connection Type	None	
Voltage Transformer Ratio	5.00:1	
Neutral Voltage Transformer	No	
Neutral VT Ratio	5.00:1	
GENERATOR PARAMETERS		
Generator Rated MVA	-----	
Generator Rated Power Factor	-----	
Generator Voltage Ph-Ph	-----	
Generator Nominal Frequency	-----	
Generator Phase Sequence	-----	
SERIAL START/STOP		
Serial Start/Stop Initiation	Off	
Startup Initiation Relays	----	
Shutdown Initiation Relays	----	
Serial Start/Stop Events		

A

Table A-3: SETPOINTS PAGE 3 – DIGITAL INPUTS (Sheet 1 of 3)

DESCRIPTION	DEFAULT	USER VALUE
BREAKER STATUS		
Breaker Status	Auxiliary B	
GENERAL INPUT A		
Assign Digital Input	None	
Asserted Digital Input State	Closed	
Input Name	Input A	
Block Input From Online	0 sec.	
General Input A Control	Off	
Pulsed Control Relay Dwell Time	0.0 sec.	
Assign Control Relays	----	
General Input A Control Events	Off	
General Input A Alarm	Off	
Assign Alarm Relays	----	
General Input A Alarm Delay	5.0 sec.	
General Input A Alarm Events	Off	
General Input A Trip	Off	
Assign Trip Relays	----	
General Input A Trip Delay	5.0 sec.	
GENERAL INPUT B		
Assign Digital Input	None	
Asserted Digital Input State	Closed	
Input Name	Input B	
Block Input From Online	0 sec.	
General Input B Control	Off	
Pulsed Control Relay Dwell Time	0.0 sec.	
Assign Control Relays	----	
General Input B Control Events	Off	
General Input B Alarm	Off	
Assign Alarm Relays	----	
General Input B Alarm Delay	5.0 sec.	
General Input B Alarm Events	Off	
General Input B Trip	Off	
Assign Trip Relays	----	
General Input B Trip Delay	5.0 sec.	

DESCRIPTION	DEFAULT	USER VALUE
GENERAL INPUT C		
Assign Digital Input	None	
Asserted Digital Input State	Closed	
Input Name	Input C	
Block Input From Online	0 sec.	
General Input C Control	Off	
Pulsed Control Relay Dwell Time	0.0 sec.	
Assign Control Relays	----	
General Input C Control Events	Off	
General Input C Alarm	Off	
Assign Alarm Relays	----	
General Input C Alarm Delay	5.0 sec.	
General Input C Alarm Events	Off	
General Input C Trip	Off	
Assign Trip Relays	----	
General Input C Trip Delay	5.0 sec.	
GENERAL INPUT D		
Assign Digital Input	None	
Asserted Digital Input State	Closed	
Input Name	Input D	
Block Input From Online	0 sec.	
General Input D Control	Off	
Pulsed Control Relay Dwell Time	0.0 sec.	
Assign Control Relays	----	
General Input D Control Events	Off	
General Input D Alarm	Off	
Assign Alarm Relays	----	
General Input D Alarm Delay	5.0 sec.	
General Input D Alarm Events	Off	
General Input D Trip	Off	
Assign Trip Relays	----	
General Input D Trip Delay	5.0 sec.	
Assign Trip Relays		

Table A-3: SETPOINTS PAGE 3 – DIGITAL INPUTS (Sheet 2 of 3)

DESCRIPTION	DEFAULT	USER VALUE	DESCRIPTION	DEFAULT	USER VALUE
GENERAL INPUT E			GENERAL INPUT G		
Assign Digital Input	None		Assign Digital Input	None	
Asserted Digital Input State	Closed		Asserted Digital Input State	Closed	
Input Name	Input E		Input Name	Input G	
Block Input From Online	0 sec.		Block Input From Online	0 sec.	
General Input E Control	Off		General Input G Control	Off	
Pulsed Control Relay Dwell Time	0.0 sec.		Pulsed Control Relay Dwell Time	0.0 sec.	
Assign Control Relays	----		Assign Control Relays	----	
General Input E Control Events	Off		General Input G Control Events	Off	
General Input E Alarm	Off		General Input G Alarm	Off	
Assign Alarm Relays	----		Assign Alarm Relays	----	
General Input E Alarm Delay	5.0 sec.		General Input G Alarm Delay	5.0 sec.	
General Input E Alarm Events	Off		General Input G Alarm Events	Off	
General Input E Trip	Off		General Input G Trip	Off	
Assign Trip Relays	----		Assign Trip Relays	----	
General Input E Trip Delay	5.0 sec.		General Input G Trip Delay	5.0 sec.	
GENERAL INPUT F			REMOTE RESET		
Assign Digital Input	None		Assign Digital Input	None	
Asserted Digital Input State	Closed		TEST INPUT		
Input Name	Input F		Assign Digital Input	None	
Block Input From Online	0 sec.		THERMAL RESET		
General Input F Control	Off		Assign Digital Input	None	
Pulsed Control Relay Dwell Time	0.0 sec.		DUAL SETPOINTS		
Assign Control Relays	----		Assign Digital Input	None	
General Input F Control Events	Off		Activate Setpoint Group	Group 1	
General Input F Alarm	Off		Edit Setpoint Group	Group 1	
Assign Alarm Relays	----		SEQUENTIAL TRIP		
General Input F Alarm Delay	5.0 sec.		Assign Digital Input	None	
General Input F Alarm Events	Off		Sequential Trip Type	Low Fwd Pwr	
General Input F Trip	Off		Assign Trip Relays	----	
Assign Trip Relays	----		Sequential Trip Level	0.05 × Rated	
General Input F Trip Delay	5.0 sec.		Sequential Trip Delay	1.0 sec.	

A

A

Table A-3: SETPOINTS PAGE 3 – DIGITAL INPUTS (Sheet 3 of 3)

DESCRIPTION	DEFAULT	USER VALUE
FIELD-BREAKER DISCREPANCY		
Assign Digital Input	None	
Field Status Contact	Auxiliary A	
Assign Trip Relays	----	
Field-Bkr Discrep. Trip Delay	1.0 sec.	
WAVEFORM CAPTURE		
Assign Digital Input	None	
GROUND SWITCH STATUS		
Assign Digital Input	None	
Ground Switch Contact	Auxiliary A	

DESCRIPTION	DEFAULT	USER VALUE
TACHOMETER		
Assign Digital Input	None	
Rated Speed	3600 RPM	
Tachometer Alarm	Off	
Assign Alarm Relays	----	
Tachometer Alarm Speed	110% Rated	
Tachometer Alarm Delay	1 sec.	
Tachometer Alarm Events	Off	
Tachometer Trip	Off	
Assign Trip Relays	----	
Tachometer Trip Speed	110% Rated	
Tachometer Trip Delay	1 sec.	

Table A-4: SETPOINTS PAGE 4 – OUTPUT RELAYS

DESCRIPTION	DEFAULT	USER VALUE
RELAY RESET MODE		
R1 Trip	All Resets	
R2 Auxiliary	All Resets	
R3 Auxiliary	All Resets	
R4 Auxiliary	All Resets	
R5 Alarm	All Resets	
R6 Service	All Resets	

Table A-5: SETPOINTS PAGE 5 – CURRENT ELEMENTS (Sheet 1 of 7)

DESCRIPTION	DEFAULT	USER VALUE SETPOINT GROUP 1	USER VALUE SETPOINT GROUP 2
OVERCURRENT ALARM			
Overcurrent Alarm	Off		
Assign Alarm Relays	----		
Overcurrent Alarm Level	1.01 × FLA		
Overcurrent Alarm Delay	0.1 sec.		
Overcurrent Alarm Events	Off		
OFFLINE OVERCURRENT			
Offline Overcurrent Trip	Off		
Assign Trip Relays	----		
Offline Overcurrent Pickup	0.05 × CT		
Offline Overcurrent Trip Delay	5 cycles		
INADVERTENT ENERGIZATION			
Inadvertent Energization Trip	Off		
Assign Trip Relays	----		
Arming Signal	U/V and Offline		
Inadvertent Energize O/C Pickup	0.05 × CT		
Inadvertent Energize Pickup	0.50 × Rated V		
VOLTAGE RESTRAINED PHASE OVERCURRENT			
Phase Overcurrent Trip	Off		
Assign Trip Relays	----		
Enable Voltage Restraint	No		
Voltage Lower Limit	10%		
Phase Overcurrent Pickup	10.00 × CT		
Curve Shape	ANSI Extremely Inv.		
Flexcurve Trip Time at 1.03 x PU	65535 ms		
Flexcurve Trip Time at 1.05 x PU	65535 ms		
Flexcurve Trip Time at 1.10 x PU	65535 ms		
Flexcurve Trip Time at 1.20 x PU	65535 ms		
Flexcurve Trip Time at 1.30 x PU	65535 ms		
Flexcurve Trip Time at 1.40 x PU	65535 ms		
Flexcurve Trip Time at 1.50 x PU	65535 ms		
Flexcurve Trip Time at 1.60 x PU	65535 ms		
Flexcurve Trip Time at 1.70 x PU	65535 ms		
Flexcurve Trip Time at 1.80 x PU	65535 ms		
Flexcurve Trip Time at 1.90 x PU	65535 ms		
Flexcurve Trip Time at 2.00 x PU	65535 ms		
Flexcurve Trip Time at 2.10 x PU	65535 ms		
Flexcurve Trip Time at 2.20 x PU	65535 ms		
Flexcurve Trip Time at 2.30 x PU	65535 ms		

A

Table A-5: SETPOINTS PAGE 5 – CURRENT ELEMENTS (Sheet 2 of 7)

DESCRIPTION	DEFAULT	USER VALUE SETPOINT GROUP 1	USER VALUE SETPOINT GROUP 2
Flexcurve Trip Time at 2.40 x PU	65535 ms		
Flexcurve Trip Time at 2.50 x PU	65535 ms		
Flexcurve Trip Time at 2.60 x PU	65535 ms		
Flexcurve Trip Time at 2.70 x PU	65535 ms		
Flexcurve Trip Time at 2.80 x PU	65535 ms		
Flexcurve Trip Time at 2.90 x PU	65535 ms		
Flexcurve Trip Time at 3.00 x PU	65535 ms		
Flexcurve Trip Time at 3.10 x PU	65535 ms		
Flexcurve Trip Time at 3.20 x PU	65535 ms		
Flexcurve Trip Time at 3.30 x PU	65535 ms		
Flexcurve Trip Time at 3.40 x PU	65535 ms		
Flexcurve Trip Time at 3.50 x PU	65535 ms		
Flexcurve Trip Time at 3.60 x PU	65535 ms		
Flexcurve Trip Time at 3.70 x PU	65535 ms		
Flexcurve Trip Time at 3.80 x PU	65535 ms		
Flexcurve Trip Time at 3.90 x PU	65535 ms		
Flexcurve Trip Time at 4.00 x PU	65535 ms		
Flexcurve Trip Time at 4.10 x PU	65535 ms		
Flexcurve Trip Time at 4.20 x PU	65535 ms		
Flexcurve Trip Time at 4.30 x PU	65535 ms		
Flexcurve Trip Time at 4.40 x PU	65535 ms		
Flexcurve Trip Time at 4.50 x PU	65535 ms		
Flexcurve Trip Time at 4.60 x PU	65535 ms		
Flexcurve Trip Time at 4.70 x PU	65535 ms		
Flexcurve Trip Time at 4.80 x PU	65535 ms		
Flexcurve Trip Time at 4.90 x PU	65535 ms		
Flexcurve Trip Time at 5.00 x PU	65535 ms		
Flexcurve Trip Time at 5.10 x PU	65535 ms		
Flexcurve Trip Time at 5.20 x PU	65535 ms		
Flexcurve Trip Time at 5.30 x PU	65535 ms		
Flexcurve Trip Time at 5.40 x PU	65535 ms		
Flexcurve Trip Time at 5.50 x PU	65535 ms		
Flexcurve Trip Time at 5.60 x PU	65535 ms		
Flexcurve Trip Time at 5.70 x PU	65535 ms		
Flexcurve Trip Time at 5.80 x PU	65535 ms		
Flexcurve Trip Time at 5.90 x PU	65535 ms		
Flexcurve Trip Time at 6.00 x PU	65535 ms		
Flexcurve Trip Time at 6.50 x PU	65535 ms		
Flexcurve Trip Time at 7.00 x PU	65535 ms		

Table A-5: SETPOINTS PAGE 5 – CURRENT ELEMENTS (Sheet 3 of 7)

DESCRIPTION	DEFAULT	USER VALUE SETPOINT GROUP 1	USER VALUE SETPOINT GROUP 2
Flexcurve Trip Time at 7.50 x PU	65535 ms		
Flexcurve Trip Time at 8.00 x PU	65535 ms		
Flexcurve Trip Time at 8.50 x PU	65535 ms		
Flexcurve Trip Time at 9.00 x PU	65535 ms		
Flexcurve Trip Time at 9.50 x PU	65535 ms		
Flexcurve Trip Time at 10.00 x PU	65535 ms		
Flexcurve Trip Time at 10.50 x PU	65535 ms		
Flexcurve Trip Time at 11.00 x PU	65535 ms		
Flexcurve Trip Time at 11.50 x PU	65535 ms		
Flexcurve Trip Time at 12.00 x PU	65535 ms		
Flexcurve Trip Time at 12.50 x PU	65535 ms		
Flexcurve Trip Time at 13.00 x PU	65535 ms		
Flexcurve Trip Time at 13.50 x PU	65535 ms		
Flexcurve Trip Time at 14.00 x PU	65535 ms		
Flexcurve Trip Time at 14.50 x PU	65535 ms		
Flexcurve Trip Time at 15.00 x PU	65535 ms		
Flexcurve Trip Time at 15.50 x PU	65535 ms		
Flexcurve Trip Time at 16.00 x PU	65535 ms		
Flexcurve Trip Time at 16.50 x PU	65535 ms		
Flexcurve Trip Time at 17.00 x PU	65535 ms		
Flexcurve Trip Time at 17.50 x PU	65535 ms		
Flexcurve Trip Time at 18.00 x PU	65535 ms		
Flexcurve Trip Time at 18.50 x PU	65535 ms		
Flexcurve Trip Time at 19.00 x PU	65535 ms		
Flexcurve Trip Time at 19.50 x PU	65535 ms		
Flexcurve Trip Time at 20.00 x PU	65535 ms		
Overcurrent Curve Multiplier	1.00		
Overcurrent Curve Reset	Instantaneous		

A

Table A-5: SETPOINTS PAGE 5 – CURRENT ELEMENTS (Sheet 4 of 7)

DESCRIPTION	DEFAULT	USER VALUE SETPOINT GROUP 1	USER VALUE SETPOINT GROUP 2
NEGATIVE SEQUENCE OVERCURRENT			
Negative Sequence Alarm	Off		
Assign Alarm Relays	---5		
Negative Sequence Alarm Pickup	3% FLA		
Negative Sequence Alarm Delay	5.0 sec.		
Negative Sequence Alarm Events	Off		
Negative Sequence O/C Trip	Off		
Assign Trip Relays	1---		
Neg. Sequence O/C Trip Pickup	8% FLA		
Neg. Sequence O/C Constant K	1		
Neg. Sequence O/C Max. Time	1000 sec.		
Neg. Sequence O/C Reset Rate	227.0 sec.		
GROUND OVERCURRENT			
Ground Overcurrent Alarm	Off		
Assign Alarm Relays	---5		
Ground Overcurrent Alarm Pickup	0.20 × CT		
Ground Overcurrent Alarm Delay	0 cycles		
Ground Overcurrent Alarm Events	Off		
Ground Overcurrent Trip	Off		
Assign Trip Relays	1---		
Ground Overcurrent Trip Pickup	0.20 × CT		
Curve Shape	ANSI Extremely Inv.		
Neg. Sequence O/C Max. Time	1000 sec.		
Neg. Sequence O/C Reset Rate	227.0 sec.		
Flexcurve Trip Time at 1.03 x PU	65535 ms		
Flexcurve Trip Time at 1.05 x PU	65535 ms		
Flexcurve Trip Time at 1.10 x PU	65535 ms		
Flexcurve Trip Time at 1.20 x PU	65535 ms		
Flexcurve Trip Time at 1.30 x PU	65535 ms		
Flexcurve Trip Time at 1.40 x PU	65535 ms		
Flexcurve Trip Time at 1.50 x PU	65535 ms		
Flexcurve Trip Time at 1.60 x PU	65535 ms		
Flexcurve Trip Time at 1.70 x PU	65535 ms		
Flexcurve Trip Time at 1.80 x PU	65535 ms		
Flexcurve Trip Time at 1.90 x PU	65535 ms		
Flexcurve Trip Time at 2.00 x PU	65535 ms		
Flexcurve Trip Time at 2.10 x PU	65535 ms		
Flexcurve Trip Time at 2.20 x PU	65535 ms		
Flexcurve Trip Time at 2.30 x PU	65535 ms		

Table A-5: SETPOINTS PAGE 5 – CURRENT ELEMENTS (Sheet 5 of 7)

DESCRIPTION	DEFAULT	USER VALUE SETPOINT GROUP 1	USER VALUE SETPOINT GROUP 2
Flexcurve Trip Time at 2.40 x PU	65535 ms		
Flexcurve Trip Time at 2.50 x PU	65535 ms		
Flexcurve Trip Time at 2.60 x PU	65535 ms		
Flexcurve Trip Time at 2.70 x PU	65535 ms		
Flexcurve Trip Time at 2.80 x PU	65535 ms		
Flexcurve Trip Time at 2.90 x PU	65535 ms		
Flexcurve Trip Time at 3.00 x PU	65535 ms		
Flexcurve Trip Time at 3.10 x PU	65535 ms		
Flexcurve Trip Time at 3.20 x PU	65535 ms		
Flexcurve Trip Time at 3.30 x PU	65535 ms		
Flexcurve Trip Time at 3.40 x PU	65535 ms		
Flexcurve Trip Time at 3.50 x PU	65535 ms		
Flexcurve Trip Time at 3.60 x PU	65535 ms		
Flexcurve Trip Time at 3.70 x PU	65535 ms		
Flexcurve Trip Time at 3.80 x PU	65535 ms		
Flexcurve Trip Time at 3.90 x PU	65535 ms		
Flexcurve Trip Time at 4.00 x PU	65535 ms		
Flexcurve Trip Time at 4.10 x PU	65535 ms		
Flexcurve Trip Time at 4.20 x PU	65535 ms		
Flexcurve Trip Time at 4.30 x PU	65535 ms		
Flexcurve Trip Time at 4.40 x PU	65535 ms		
Flexcurve Trip Time at 4.50 x PU	65535 ms		
Flexcurve Trip Time at 4.60 x PU	65535 ms		
Flexcurve Trip Time at 4.70 x PU	65535 ms		
Flexcurve Trip Time at 4.80 x PU	65535 ms		
Flexcurve Trip Time at 4.90 x PU	65535 ms		
Flexcurve Trip Time at 5.00 x PU	65535 ms		
Flexcurve Trip Time at 5.10 x PU	65535 ms		
Flexcurve Trip Time at 5.20 x PU	65535 ms		
Flexcurve Trip Time at 5.30 x PU	65535 ms		
Flexcurve Trip Time at 5.40 x PU	65535 ms		
Flexcurve Trip Time at 5.50 x PU	65535 ms		
Flexcurve Trip Time at 5.60 x PU	65535 ms		
Flexcurve Trip Time at 5.70 x PU	65535 ms		
Flexcurve Trip Time at 5.80 x PU	65535 ms		
Flexcurve Trip Time at 5.90 x PU	65535 ms		
Flexcurve Trip Time at 6.00 x PU	65535 ms		
Flexcurve Trip Time at 6.50 x PU	65535 ms		
Flexcurve Trip Time at 7.00 x PU	65535 ms		

A

Table A-5: SETPOINTS PAGE 5 – CURRENT ELEMENTS (Sheet 6 of 7)

DESCRIPTION	DEFAULT	USER VALUE SETPOINT GROUP 1	USER VALUE SETPOINT GROUP 2
Flexcurve Trip Time at 7.50 x PU	65535 ms		
Flexcurve Trip Time at 8.00 x PU	65535 ms		
Flexcurve Trip Time at 8.50 x PU	65535 ms		
Flexcurve Trip Time at 9.00 x PU	65535 ms		
Flexcurve Trip Time at 9.50 x PU	65535 ms		
Flexcurve Trip Time at 10.00 x PU	65535 ms		
Flexcurve Trip Time at 10.50 x PU	65535 ms		
Flexcurve Trip Time at 11.00 x PU	65535 ms		
Flexcurve Trip Time at 11.50 x PU	65535 ms		
Flexcurve Trip Time at 12.00 x PU	65535 ms		
Flexcurve Trip Time at 12.50 x PU	65535 ms		
Flexcurve Trip Time at 13.00 x PU	65535 ms		
Flexcurve Trip Time at 13.50 x PU	65535 ms		
Flexcurve Trip Time at 14.00 x PU	65535 ms		
Flexcurve Trip Time at 14.50 x PU	65535 ms		
Flexcurve Trip Time at 15.00 x PU	65535 ms		
Flexcurve Trip Time at 15.50 x PU	65535 ms		
Flexcurve Trip Time at 16.00 x PU	65535 ms		
Flexcurve Trip Time at 16.50 x PU	65535 ms		
Flexcurve Trip Time at 17.00 x PU	65535 ms		
Flexcurve Trip Time at 17.50 x PU	65535 ms		
Flexcurve Trip Time at 18.00 x PU	65535 ms		
Flexcurve Trip Time at 18.50 x PU	65535 ms		
Flexcurve Trip Time at 19.00 x PU	65535 ms		
Flexcurve Trip Time at 19.50 x PU	65535 ms		
Flexcurve Trip Time at 20.00 x PU	65535 ms		
Overcurrent Curve Multiplier	1.00		
Overcurrent Curve Reset	Instantaneous		

Table A-5: SETPOINTS PAGE 5 – CURRENT ELEMENTS (Sheet 7 of 7)

DESCRIPTION	DEFAULT	USER VALUE SETPOINT GROUP 1	USER VALUE SETPOINT GROUP 2
PHASE DIFFERENTIAL			
Phase Differential Trip	Off		
Assign Trip Relays	1---		
Differential Trip Min. Pickup	$0.10 \times CT$		
Differential Trip Slope 1	10%		
Differential Trip Slope 2	20%		
Differential Trip Delay	0 cycles		
Assign Trip Relays	1---		
GROUND DIRECTIONAL			
Supervise With Digital Input	Yes		
Ground Directional MTA	0°		
Ground Directional Alarm	Off		
Assign Alarm Relays	---5		
Ground Directional Alarm Pickup	$0.05 \times CT$		
Ground Directional Alarm Delay	3.0 sec.		
Ground Directional Alarm Events	Off		
Ground Directional Trip	Off		
Assign Trip Relays	1---		
Ground Directional Trip Pickup	$0.05 \times CT$		
Ground Directional Trip Delay	3.0 sec.		
HIGH-SET PHASE OVERCURRENT			
High-Set Phase Overcurrent Trip	Off		
Assign Trip Relays	1---		
High-Set Phase O/C Pickup	$5.00 \times CT$		
High-Set Phase O/C Delay	1.00 sec.		

A

Table A-6: SETPOINTS PAGE 6 – VOLTAGE ELEMENTS (Sheet 1 of 3)

DESCRIPTION	DEFAULT	USER VALUE SETPOINT GROUP 1	USER VALUE SETPOINT GROUP 2
UNDERVOLTAGE			
Undervoltage Alarm	Off		
Assign Alarm Relays	---5		
Undervoltage Alarm Pickup	$0.85 \times \text{Rated}$		
Undervoltage Alarm Delay	3.0 sec.		
Undervoltage Alarm Events	Off		
Undervoltage Trip	Off		
Assign Trip Relays	1---		
Undervoltage Trip Pickup	$0.80 \times \text{Rated}$		
Undervoltage Trip Delay	1.0 sec.		
Undervoltage Curve Reset Rate	1.4 sec.		
Undervoltage Trip Element	Curve		
OVERVOLTAGE			
Overtoltage Alarm	Off		
Assign Alarm Relays	---5		
Overtoltage Alarm Pickup	$1.15 \times \text{Rated}$		
Overtoltage Alarm Delay	3.0 sec.		
Overtoltage Alarm Events	Off		
Overtoltage Trip	Off		
Assign Trip Relays	1---		
Overtoltage Trip Pickup	$1.20 \times \text{Rated}$		
Overtoltage Trip Delay	1.0 sec.		
Overtoltage Curve Reset Rate	1.4 sec.		
Overtoltage Trip Element	Curve		
VOLTS/HERTZ			
Volts/Hertz Alarm	Off		
Assign Alarm Relays	---5		
Volts/Hertz Alarm Pickup	$1.00 \times \text{Nominal}$		
Volts/Hertz Alarm Delay	3.0 sec.		
Volts/Hertz Alarm Events	Off		
Volts/Hertz Trip	Off		
Assign Trip Relays	1---		
Volts/Hertz Trip Pickup	$1.00 \times \text{Nominal}$		
Volts/Hertz Trip Delay	1.0 sec.		
Volts/Hertz Curve Reset Rate	1.4 sec.		
Volts/Hertz Trip Element	Curve #1		
UNDERFREQUENCY			
Block Underfrequency From Online	1.0 sec		
Voltage Level Cutoff	$0.50 \times \text{Rated}$		

Table A-6: SETPOINTS PAGE 6 – VOLTAGE ELEMENTS (Sheet 2 of 3)

DESCRIPTION	DEFAULT	USER VALUE SETPOINT GROUP 1	USER VALUE SETPOINT GROUP 2
Underfrequency Alarm	Off		
Assign Alarm Relays	---5		
Underfrequency Alarm Level	59.50 Hz		
Underfrequency Alarm Delay	5.0 sec.		
Underfrequency Alarm Events	Off		
Underfrequency Trip	Off		
Assign Trip Relays	1---		
Underfrequency Trip Level1	59.50 Hz		
Underfrequency Trip Delay1	60.0 sec.		
Underfrequency Trip Level2	58.00 Hz		
Underfrequency Trip Delay2	30.0 sec.		
OVERFREQUENCY			
Block Overfrequency From Online	1.0 sec		
Voltage Level Cutoff	0.50 × Rated		
Overfrequency Alarm	Off		
Assign Alarm Relays	---5		
Overfrequency Alarm Level	60.50 Hz		
Overfrequency Alarm Delay	5.0 sec.		
Overfrequency Alarm Events	Off		
Overfrequency Trip	Off		
Assign Trip Relays	1---		
Overfrequency Trip Level1	60.50 Hz		
Overfrequency Trip Delay1	60.0 sec.		
Overfrequency Trip Level2	62.00 Hz		
Overfrequency Trip Delay2	30.0 sec.		
NEUTRAL OVERVOLTAGE			
Supervise With Digital Input	No		
Neutral Overvoltage Alarm	Off		
Assign Alarm Relays	---5		
Neutral Overvoltage Alarm Level	3.0 Vsec.		
Neutral Overvoltage Alarm Delay	1.0 sec.		
Neutral Overvoltage Alarm Events	Off		
Neutral Overvoltage Trip	Off		
Assign Trip Relays	1---		
Neutral Overvoltage Trip Level	5.0 Vsec.		
Neutral Overvoltage Trip Delay	1.0 sec.		
Neutral O/V Curve Reset Rate	0.0		
Neutral Overvoltage Trip Element	Definite Time		

A

Table A-6: SETPOINTS PAGE 6 – VOLTAGE ELEMENTS (Sheet 3 of 3)

DESCRIPTION	DEFAULT	USER VALUE SETPOINT GROUP 1	USER VALUE SETPOINT GROUP 2
NEUTRAL UNDERVOLTAGE (3RD HARMONIC)			
Low Power Blocking Level	0.05 × Rated MW		
Low Voltage Blocking Level	0.75 × Rated		
Neutral Undervoltage Alarm	Off		
Assign Alarm Relays	---5		
Neutral Undervoltage Alarm Level	0.5 Vsec.		
Neutral Undervoltage Alarm Delay	30.0 sec.		
Neutral Undervoltage Alarm Events	Off		
Neutral Undervoltage Trip	Off		
Assign Trip Relays	1---		
Neutral Undervoltage Trip Level	1.0 Vsec.		
Neutral Undervoltage Trip Delay	30.0 sec.		
LOSS OF EXCITATION			
Enable Voltage Supervision	Yes		
Voltage Level	0.70 × Rated		
Circle 1 Trip	Off		
Assign Circle 1 Trip Relays	1---		
Circle 1 Diameter	25.0 Ωsec.		
Circle 1 Offset	2.5 Ωsec.		
Circle 1 Trip Delay	5.0 sec.		
Circle 2 Trip	Off		
Assign Circle 2 Trip Relays	1---		
Circle 2 Diameter	35.0 Ωsec.		
Circle 2 Offset	2.5 Ωsec.		
Circle 2 Trip Delay	5.0 sec.		
DISTANCE ELEMENTS			
Step Up Transformer Setup	None		
Fuse Failure Supervision	On		
Zone #1 Trip	Off		
Assign Zone #1 Trip Relays	1---		
Zone #1 Reach	10.0 Ωsec.		
Zone #1 Angel	75°		
Zone #1 Trip Delay	0.4 sec.		
Zone #2 Trip	Off		
Assign Zone #2 Trip Relays	1---		
Zone #2 Reach	15.0 Ωsec.		
Zone #2 Angle	75°		
Zone #2 Trip Delay	2.0 sec.		

Table A-7: SETPOINTS PAGE 7 – POWER ELEMENTS

DESCRIPTION	DEFAULT	USER VALUE SETPOINT GROUP 1	USER VALUE SETPOINT GROUP 2
REACTIVE POWER			
Block Mvar Element From Online	1 sec.		
Reactive Power Alarm	Off		
Assign Alarm Relays	---5		
Positive Mvar Alarm Level	0.85 × Rated		
Negative Mvar Alarm Level	0.85 × Rated		
Positive Mvar Alarm Delay	10.0 sec.		
Negative Mvar Alarm Delay	10.0 sec.		
Reactive Power Alarm Events	Off		
Reactive Power Trip	Off		
Assign Trip Relays	1---		
Positive Mvar Trip Level	0.80 × Rated		
Negative Mvar Trip Level	0.80 × Rated		
Positive Mvar Trip Delay	20.0 sec.		
Negative Mvar Trip Delay	20.0 sec.		
REVERSE POWER			
Block Reverse Power From Online	1 sec.		
Reverse Power Alarm	Off		
Assign Alarm Relays	---5		
Reverse Power Alarm Level	0.05 × Rated MW		
Reverse Power Alarm Delay	10.0 sec.		
Reverse Power Alarm Events	Off		
Reverse Power Trip	Off		
Assign Trip Relays	1---		
Reverse Power Trip Level	0.05 × Rated MW		
Reverse Power Trip Delay	20.0 sec.		
LOW FORWARD POWER			
Block Low Fwd Power From Online	0 sec.		
Low Forward Power Alarm	Off		
Assign Alarm Relays	---5		
Low Forward Power Alarm Level	0.05 × Rated MW		
Low Forward Power Alarm Delay	10.0 sec.		
Low Forward Power Alarm Events	Off		
Low Forward Power Trip	Off		
Assign Trip Relays	1---		
Low Forward Power Trip Level	0.05 × Rated MW		
Low Forward Power Trip Delay	20.0 sec.		

A

Table A-8: SETPOINTS PAGE 8 – RTD TEMPERATURE (SETPOINT GROUP 1)

DESCRIPTION	DEFAULT	USER VALUE
RTD TYPES		
Stator RTD Type	100 Ω Platinum	
Bearing RTD Type	100 Ω Platinum	
Ambient RTD Type	100 Ω Platinum	
Other RTD Type	100 Ω Platinum	
OPEN RTD SENSOR		
Open RTD Sensor Alarm	Off	
Assign Alarm Relays	---5	
Open RTD Sensor Alarm Events	Off	

DESCRIPTION	DEFAULT	USER VALUE
RTD SHORT/LOW TEMP.		
RTD Short/Low Temp Alarm	Off	
Assign Alarm Relays	---5	
RTD Short/Low Temp. Alm Events	Off	

RTD	APPLICATION	NAME	ALARM	ASSIGN ALARM RELAYS	ALARM TEMPERATURE	ALARM EVENTS
1						
2						
3						
4						
5						
6						
7						
8						
9						
10						
11						
12						

RTD	TRIP	TRIP VOTING	ASSIGN TRIP RELAYS	TRIP TEMPERATURE
1				
2				
3				
4				
5				
6				
7				
8				
9				
10				
11				
12				

Table A-9: SETPOINTS PAGE 8 – RTD TEMPERATURE (SETPOINT GROUP 2)

DESCRIPTION	DEFAULT	USER VALUE	DESCRIPTION	DEFAULT	USER VALUE
RTD TYPES			RTD SHORT/LOW TEMP.		
Stator RTD Type	100 Ω Platinum		RTD Short/Low Temp Alarm	Off	
Bearing RTD Type	100 Ω Platinum		Assign Alarm Relays	---5	
Ambient RTD Type	100 Ω Platinum		RTD Short/Low Tmp. Alm Events	Off	
Other RTD Type	100 Ω Platinum				
OPEN RTD SENSOR					
Open RTD Sensor Alarm	Off				
Assign Alarm Relays	---5				
Open RTD Sensor Alarm Events	Off				

RTD	APPLICATION	NAME	ALARM	ASSIGN ALARM RELAYS	ALARM TEMPERATURE	ALARM EVENTS
1						
2						
3						
4						
5						
6						
7						
8						
9						
10						
11						
12						

RTD	TRIP	TRIP VOTING	ASSIGN TRIP RELAYS	TRIP TEMPERATURE
1				
2				
3				
4				
5				
6				
7				
8				
9				
10				
11				
12				

A

Table A-10: SETPOINTS PAGE 9 – THERMAL MODEL (Sheet 1 of 2)

DESCRIPTION	DEFAULT	USER VALUE SETPOINT GROUP 1	USER VALUE SETPOINT GROUP 2
THERMAL MODEL SETUP			
Enable Thermal Model	No		
Overload Pickup Level	1.01 × FLA		
Unbalance Bias K Factor	0		
Cool Time Constant Online	15 min.		
Cool Time Constant Offline	30 min.		
Hot/Cold Safe Stall Ratio	1.00		
Enable RTD Biasing	No		
RTD Bias Minimum	40°C		
RTD Bias Center Point	130°C		
RTD Bias Maximum	155°C		
Select Curve Style	Standard		
Standard Overload Curve Number	4		
Time to Trip at 1.01 × FLA	65535 ms		
Time to Trip at 1.05 × FLA	65535 ms		
Time to Trip at 1.10 × FLA	65535 ms		
Time to Trip at 1.20 × FLA	65535 ms		
Time to Trip at 1.30 × FLA	65535 ms		
Time to Trip at 1.40 × FLA	65535 ms		
Time to Trip at 1.50 × FLA	65535 ms		
Time to Trip at 1.75 × FLA	65535 ms		
Time to Trip at 2.00 × FLA	65535 ms		
Time to Trip at 2.25 × FLA	65535 ms		
Time to Trip at 2.50 × FLA	65535 ms		
Time to Trip at 2.75 × FLA	65535 ms		
Time to Trip at 3.00 × FLA	65535 ms		
Time to Trip at 3.25 × FLA	65535 ms		
Time to Trip at 3.50 × FLA	65535 ms		
Time to Trip at 3.75 × FLA	65535 ms		
Time to Trip at 4.00 × FLA	65535 ms		
Time to Trip at 4.25 × FLA	65535 ms		
Time to Trip at 4.50 × FLA	65535 ms		
Time to Trip at 4.75 × FLA	65535 ms		
Time to Trip at 5.00 × FLA	65535 ms		
Time to Trip at 5.50 × FLA	65535 ms		
Time to Trip at 6.00 × FLA	65535 ms		
Time to Trip at 6.50 × FLA	65535 ms		
Time to Trip at 7.00 × FLA	65535 ms		
Time to Trip at 7.50 × FLA	65535 ms		

Table A-10: SETPOINTS PAGE 9 – THERMAL MODEL (Sheet 2 of 2)

DESCRIPTION	DEFAULT	USER VALUE SETPOINT GROUP 1	USER VALUE SETPOINT GROUP 2
Time to Trip at 8.00 × FLA	65535 ms		
Time to Trip at 10.00 × FLA	65535 ms		
Time to Trip at 15.00 × FLA	65535 ms		
Time to Trip at 20.00 × FLA	65535 ms		
Minimum Allowable Voltage	80%		
Stall Current @ Minimum Voltage	4.80 × FLA		
Safe Stall Time @ Min Voltage	20.0 sec.		
Acceleration Intersect @ Min Volt	3.80 × FLA		
Stall Current @ 100% Voltage	6.00 × FLA		
Safe Stall Time @ 100% Voltage	10.0 sec.		
Accel. Intersect @ 100% Voltage	5.00 × FLA		
THERMAL ELEMENTS			
Thermal Model Alarm	Off		
Assign Alarm Relays	---5		
Thermal Alarm Level	75% Used		
Thermal Model Alarm Events	Off		
Thermal Model Trip	Off		
Assign Trip Relays	1---		

A

A

Table A-11: SETPOINTS PAGE 10 – MONITORING

DESCRIPTION	DEFAULT	USER VALUE
TRIP COUNTER		
Trip Counter Alarm	Off	
Assign Alarm Relays	---5	
Trip Counter Alarm Level	25 Trips	
Trip Counter Alarm Events	Off	
BREAKER FAILURE		
Breaker Failure Alarm	Off	
Assign Alarm Relays	---5	
Breaker Failure Level	1.00 × CT	
Breaker Failure Delay	100 ms	
Breaker Failure Alarm Events	Off	
TRIP COIL MONITOR		
Trip Coil Monitor Alarm	Off	
Assign Alarm Relays	---5	
Supervision of Trip Coil	52 Closed	
Trip Coil Monitor Alarm Events	Off	
VOLTAGE TRANSFORMER FUSE FAILURE		
VT Fuse Failure Alarm	Off	
Assign Alarm Relays	---5	
VT Fuse Failure Alarm Events	Off	
CURRENT DEMAND		
Current Demand Period	15 min.	
Current Demand Alarm	Off	
Assign Alarm Relays	---5	
Current Demand Limit	1.25 × FLA	
Current Demand Alarm Events	Off	
MW DEMAND		
MW Demand Period	15 min.	
MW Demand Alarm	Off	
Assign Alarm Relays	---5	
MW Demand Limit	1.25 × Rated	
MW Demand Alarm Events	Off	

DESCRIPTION	DEFAULT	USER VALUE
Mvar DEMAND		
Mvar Demand Period	15 min.	
Mvar Demand Alarm	Off	
Assign Alarm Relays	---5	
Mvar Demand Limit	1.25 × Rated	
Mvar Demand Alarm Events	Off	
MVA DEMAND		
MVA Demand Period	15 min.	
MVA Demand Alarm	Off	
Assign Alarm Relays	---5	
MVA Demand Limit	1.25 × Rated	
MVA Demand Alarm Events	Off	
PULSE OUTPUT		
Positive kWh Pulse Out Relays	----	
Positive kWh Pulse Out Interval	10 kWh	
Positive kvarh Pulse Out Relays	----	
Positive kvarh Pulse Out Interval	10 kvarh	
Negative kvarh Pulse Out Relays	----	
Negative kvarh Pulse Out Interval	10 kvarh	
Pulse Width	200 ms	
GENERATOR RUNNING HOUR SETUP		
Initial Gen. Running Hours	0 hrs.	
Generator Running Hours Alarm	Off	
Assign Alarm Relays	---5	
Generator Running Hours Limit	1000 hrs	

Table A-12: SETPOINTS PAGE 11 – ANALOG INPUT/OUTPUT

DESCRIPTION	DEFAULT	USER VALUE	DESCRIPTION	DEFAULT	USER VALUE
ANALOG OUTPUT 1			ANALOG OUTPUT 3		
Setup			Setup		
Minimum			Minimum		
Maximum			Maximum		
ANALOG OUTPUT 2			ANALOG OUTPUT 4		
Setup			Setup		
Minimum			Minimum		
Maximum			Maximum		

SETPOINT	ANALOG INPUT 1	ANALOG INPUT 2	ANALOG INPUT 3	ANALOG INPUT 4
Setup				
Name				
Units				
Minimum				
Maximum				
Block From Online				
Alarm				
Assign Alarm Relays				
Alarm Level				
Alarm Pickup				
Alarm Delay				
Alarm Events				
Trip				
Assign Trip Relays				
Trip Level				
Trip Pickup				
Trip Delay				

A

B.1.1 DESCRIPTION



This application note describes general protection concepts and provides guidelines on the use of the 489 to protect a generator stator against ground faults. Detailed connections for specific features must be obtained from the relay manual. Users are also urged to review the material contained in the 489 manual on each specific protection feature discussed here.

The 489 Generator Management Relay offers a number of elements to protect a generator against stator ground faults. Inputs are provided for a neutral-point voltage signal and for a zero-sequence current signal. The zero-sequence current input can be into a nominal 1 A secondary circuit or an input reserved for a special GE Power Management type HGF ground CT for very sensitive ground current detection. Using the HGF CT allows measurement of ground current values as low as 0.25 A primary. With impedance-grounded generators, a single ground fault on the stator does not require that the unit be quickly removed from service. The grounding impedance limits the fault current to a few amperes. A second ground fault can, however, result in significant damage to the unit. Thus the importance of detecting all ground faults, even those in the bottom 5% of the stator. The fault detection methods depend on the grounding arrangement, the availability of core balance CT, and the size of the unit. With modern full-featured digital generator protection relays such as the 489, users do not incur additional costs for extra protection elements as they are all part of the same device. This application note provides general descriptions of each of the elements in the 489 suitable for stator ground protection, and discusses some special applications.

B

B.1.2 NEUTRAL OVERVOLTAGE ELEMENT

The simplest, and one of the oldest methods to detect stator ground faults on high-impedance-grounded generators, is to sense the voltage across the stator grounding resistor [1, 2]. This is illustrated, in a simplified form in the figure below. The voltage signal is connected to the $V_{neutral}$ input of the 489, terminals E10 and F10. The $V_{neutral}$ signal is the input signal for the 489 neutral overvoltage protection element. This element has an alarm and a trip function, with separately adjustable operate levels and time delays. The trip function offers a choice of timing curves as well as a definite time delay. The neutral overvoltage function responds to fundamental frequency voltage at the generator neutral. It provides ground fault protection for approximately 95% of the stator winding. The limiting factor is the level of voltage signal available for a fault in the bottom 5% of the stator winding. The element has a range of adjustment, for the operate levels, of 2 to 100 V.

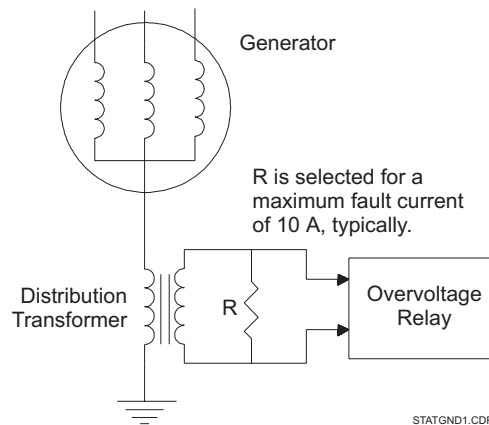

Figure B-1: STATOR GROUND FAULT PROTECTION

The operating time of this element should be coordinated with protective elements downstream, such as feeder ground fault elements, since the neutral overvoltage element will respond to external ground faults if the generator is directly connected to a power grid, without the use of a delta-wye transformer.

In addition, the time delay should be coordinated with the ground directional element (discussed later), if it is enabled, by using a longer delay on the neutral overvoltage element than on the directional element.

It is recommended that an isolation transformer be used between the relay and the grounding impedance to reduce common mode voltage problems, particularly on installations requiring long leads between the relay and the grounding impedance.

B

When several small generators are operated in parallel with a single step-up transformer, all generators may be grounded through the same impedance (the impedance normally consists of a distribution transformer and a properly sized resistor). It is possible that only one generator is grounded while the others have a floating neutral point when connected to the power grid (see the figure below). This operating mode is often adopted to prevent circulation of third-harmonic currents through the generators, if the installation is such that all the star points would end up connected together ahead of the common grounding impedance (if each generator has its own grounding impedance, the magnitude of the circulating third harmonic current will be quite small). With a common ground point, the same $V_{neutral}$ signal is brought to all the relays but only the one which is grounded should have the neutral overvoltage element in service.

For these cases, the neutral overvoltage element has been provided with a supervising signal obtained from an auxiliary contact off the grounding switch. When the grounding switch is opened, the element is disabled. The grounding switch auxiliary contact is also used in the ground directional element, as is the breaker auxiliary contact, as discussed later.

If all the generators are left grounded through the same impedance, the neutral overvoltage element in each relay will respond to a ground fault in any of the generators. For this reason, the ground directional element should be used in each relay, in addition to the neutral overvoltage element.

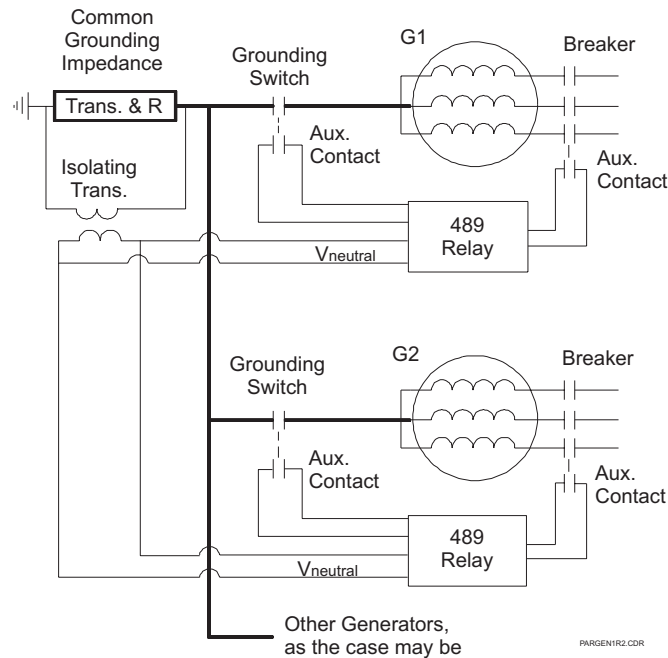

Figure B-2: PARALLEL GENERATORS WITH COMMON GROUNDING IMPEDANCE

B.1.3 GROUND OVERCURRENT ELEMENT

The ground overcurrent element can be used as a direct replacement or a backup for the neutral overvoltage element, with the appropriate current signal from the generator neutral point, for grounded generators. This element can also be used with a core balance CT, either in the neutral end or the output end of the generator, as shown below. The use of the special CT, with its dedicated input to the relay, offers very sensitive current detection, but still does not offer protection for the full stator. The setting of this element must be above the maximum unbalance current that normally flows in the neutral circuit. Having the element respond only to the fundamental frequency component allows an increase in sensitivity.

The core balance CT can be a conventional CT or a 50:0.025 ground CT, allowing the measurement of primary-side current levels down to 0.25 A. Using a core balance CT, on the output side of the transformer will provide protection against stator ground faults in ungrounded generators, provided that there is a source of zero-sequence current from the grid.

Though in theory one could use this element with a zero sequence current signal obtained from a summation of the three phase currents (neutral end or output end), by connecting it in the star point of the phase CTs, options 4 and 5 in the figure below, this approach is not very useful. The main drawback, for impedance-grounded generators is that the zero-sequence current produced by the CT ratio and phase errors could be much larger than the zero sequence current produced by a real ground fault inside the generator.

Again the time delay on this element must be coordinated with protection elements downstream, if the generator is grounded. Refer to the relay manual/3/ for the range of settings of the pickup levels and the time delays. The time delay on this element should always be longer than the longest delay on line protection downstream.

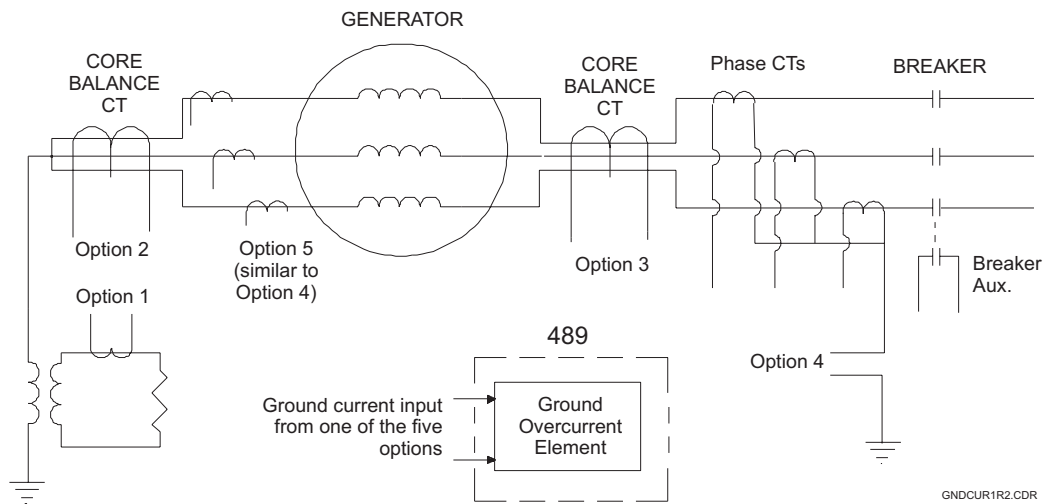

Figure B-3: GROUND OVERCURRENT ELEMENT WITH DIFFERENT CURRENT SOURCE SIGNALS

B.1.4 GROUND DIRECTIONAL ELEMENT

The 489 can detect internal stator ground faults using a Ground Directional element implemented using the $V_{neutral}$ and the ground current inputs. The voltage signal is obtained across the grounding impedance of the generator. The ground, or zero sequence, current is obtained from a core balance CT, as shown below (due to CT inaccuracies, it is generally not possible to sum the outputs of the conventional phase CTs to derive the generator high-side zero sequence current, for an impedance-grounded generator).

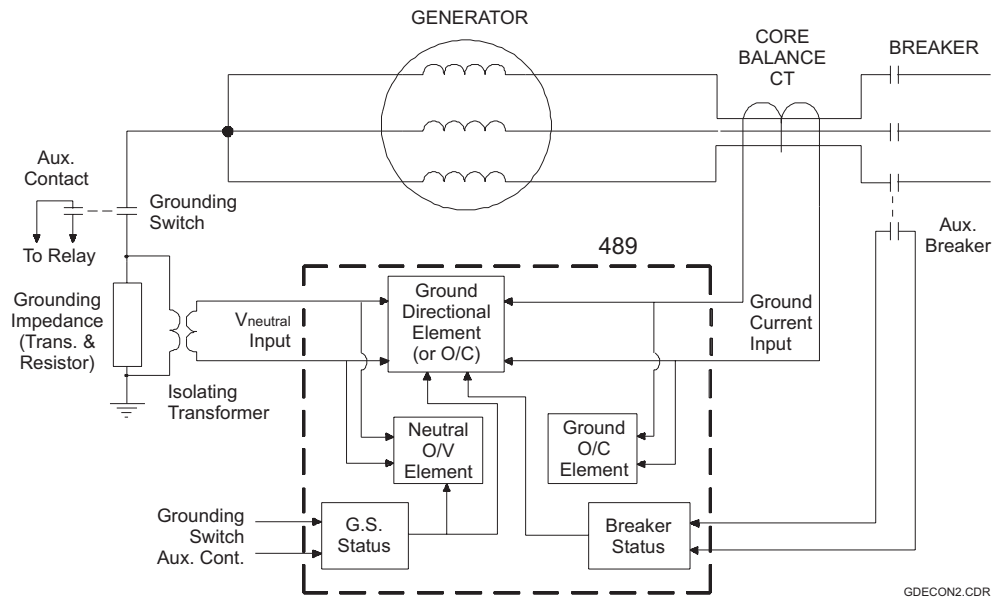

Figure B-4: GROUND DIRECTIONAL ELEMENT CONCEPTUAL ARRANGEMENT

If correct polarities are observed in the connection of all signals to the relay, the $V_{neutral}$ signal will be in phase with the ground current signal. The element has been provided with a setting allowing the user to change the plane of operation to cater to reactive grounding impedances or to polarity inversions.

This element's normal "plane of operation" for a resistor-grounded generator is the 180° plane, as shown in Figure B-5: GROUND DIRECTIONAL ELEMENT POLARITIES AND PLANE OF OPERATION, for an internal ground fault. That is, for an internal stator-to-ground fault, the V_o signal is 180° away from the I_o signal, if the polarity convention is observed. If the grounding impedance is inductive, the plane of operation will be the 270° plane, again, with the polarity convention shown below. If the polarity convention is reversed on one input, the user will need to change the plane of operation by 180° .

The operating principle of this element is quite simple: for internal ground faults the two signals will be 180° out of phase and for external ground faults, the two signals will be in phase. This simple principle allows the element to be set with a high sensitivity, not normally possible with an overcurrent element.

The current pickup level of the element can be adjusted down to $0.05 \times$ CT primary, allowing an operate level of 0.25 A primary if the 50:0.025 ground CT is used for the core balance. The minimum level of $V_{neutral}$ at which the element will operate is determined by hardware limitations and is internally set at 2.0 V.

Because this element is directional, it does not need to be coordinated with downstream protections and a short operating time can be used. Definite time delays are suitable for this element.

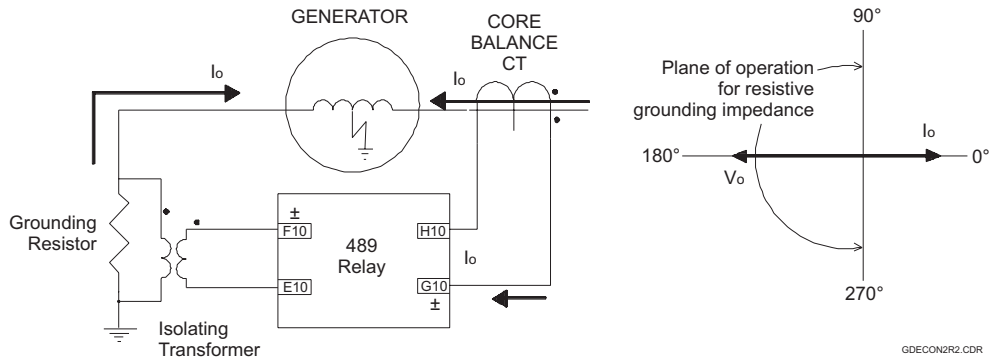

Figure B-5: GROUND DIRECTIONAL ELEMENT POLARITIES AND PLANE OF OPERATION

Applications with generators operated in parallel and grounded through a common impedance require special considerations. If only one generator is grounded and the other ones left floating, the directional element for the floating generators does not receive a correct $V_{neutral}$ signal and therefore cannot operate correctly. In those applications, the element makes use of auxiliary contacts off the grounding switch and the unit breaker to turn the element into a simple overcurrent element, with the pickup level set for the directional element (note that the ground directional element and the ground overcurrent elements are totally separate elements). In this mode, the element can retain a high sensitivity and fast operate time since it will only respond to internal stator ground faults. The table below illustrates the status of different elements under various operating conditions.

Table B-1: DETECTION ELEMENT STATUS

GENERATOR CONDITION	UNIT BREAKER	GROUNDING SWITCH	ELEMENT		
			GROUND DIRECTIONAL	NEUTRAL OVERVOLTAGE	GROUND OVERCURRENT
Shutdown	Open	Open	Out-of-service	Out-of-service	In-service
Open Circuit and grounded	Open	Closed	In-service (but will not operate due to lack of LO)	In-service	In-service
Loaded and Grounded	Closed	Closed	In-service	In-service	In-service
Loaded and Not Grounded	Closed	Open	In service as a simple overcurrent element	Out-of-service	In-service



B.1.5 THIRD HARMONIC VOLTAGE ELEMENT

The conventional neutral overvoltage element or the ground overcurrent element are not capable of reliably detecting stator ground faults in the bottom 5% of the stator, due to lack of sensitivity. In order to provide reliable coverage for the bottom part of the stator, protective elements, utilizing the third harmonic voltage signals in the neutral and at the generator output terminals, have been developed [4].

B

In the 489 relay, the third-harmonic voltage element, Neutral Undervoltage (3rd Harmonic) derives the third harmonic component of the neutral-point voltage signal from the $V_{neutral}$ signal as one signal, called V_{N3} . The third harmonic component of the internally summed phase-voltage signals is derived as the second signal, called V_{P3} . For this element to perform as originally intended, it is necessary to use wye-connected VTs.

Since the amount of third harmonic voltage that appears in the neutral is both load and machine dependent, the protection method of choice is an adaptive method. The following formula is used to create an adaptive third-harmonic scheme:

$$\frac{V_{N3}}{V_{P3}/3 + V_{N3}} \leq 0.15 \quad \text{which simplifies to} \quad V_{P3} \geq 17 V_{N3}$$

The 489 tests the following conditions prior to testing the basic operating equation to ensure that V_{N3} is of a measurable magnitude:

$$V_{P3'} > 0.25 \text{ V} \quad \text{and} \quad V_{P3'} \geq \text{Permissive_Threshold} \times 17 \times \frac{\text{Neutral CT Ratio}}{\text{Phase CT Ratio}}$$

where: V_{N3} is the magnitude of third harmonic voltage at the generator neutral
 V_{P3} is the magnitude of third harmonic voltage at the generator terminals
 $V_{P3'}$ and $V_{N3'}$ are the corresponding voltage transformer secondary values
 Permissive_Threshold is 0.15 V for the alarm element and 0.1875 V for the trip element.

In addition, the logic for this element verifies that the generator positive sequence terminal voltage is at least 30% of nominal, to ensure that the generator is actually excited.



This method of using 3rd harmonic voltages to detect *stator ground faults near the generator neutral has proved feasible on larger generators with unit transformers. Its usefulness in other generator applications is unknown.*

If the phase VT connection is "open delta", it is not possible to measure the third harmonic voltage at the generator terminals and a simple third harmonic neutral undervoltage element is used. In this case, the element is supervised by both a terminal voltage level and by a power level. When used as a simple undervoltage element, settings should be based on measured 3rd harmonic neutral voltage of the healthy machine. It is recommended that the element only be used for alarm purposes with open delta VT connections.

B.1.6 REFERENCES

1. C. R. Mason, "The Art & Science of Protective Relaying", John Wiley & Sons, Inc., 1956, Chapter 10.
2. J. Lewis Blackburn, "Protective Relaying: Principles and Applications", Marcel Dekker, Inc., New York, 1987, chapter 8.
3. GE Power Management, "Instruction Manual for the 489 Generator Management Relay".
4. R. J. Marttila, "Design Principles of a New Generator Stator Ground Relay for 100% Coverage of the Stator Winding", IEEE Transactions on Power Delivery, Vol. PWRD-1, No. 4, October 1986.



GE Power Management

489 ANSI MODERATELY INVERSE

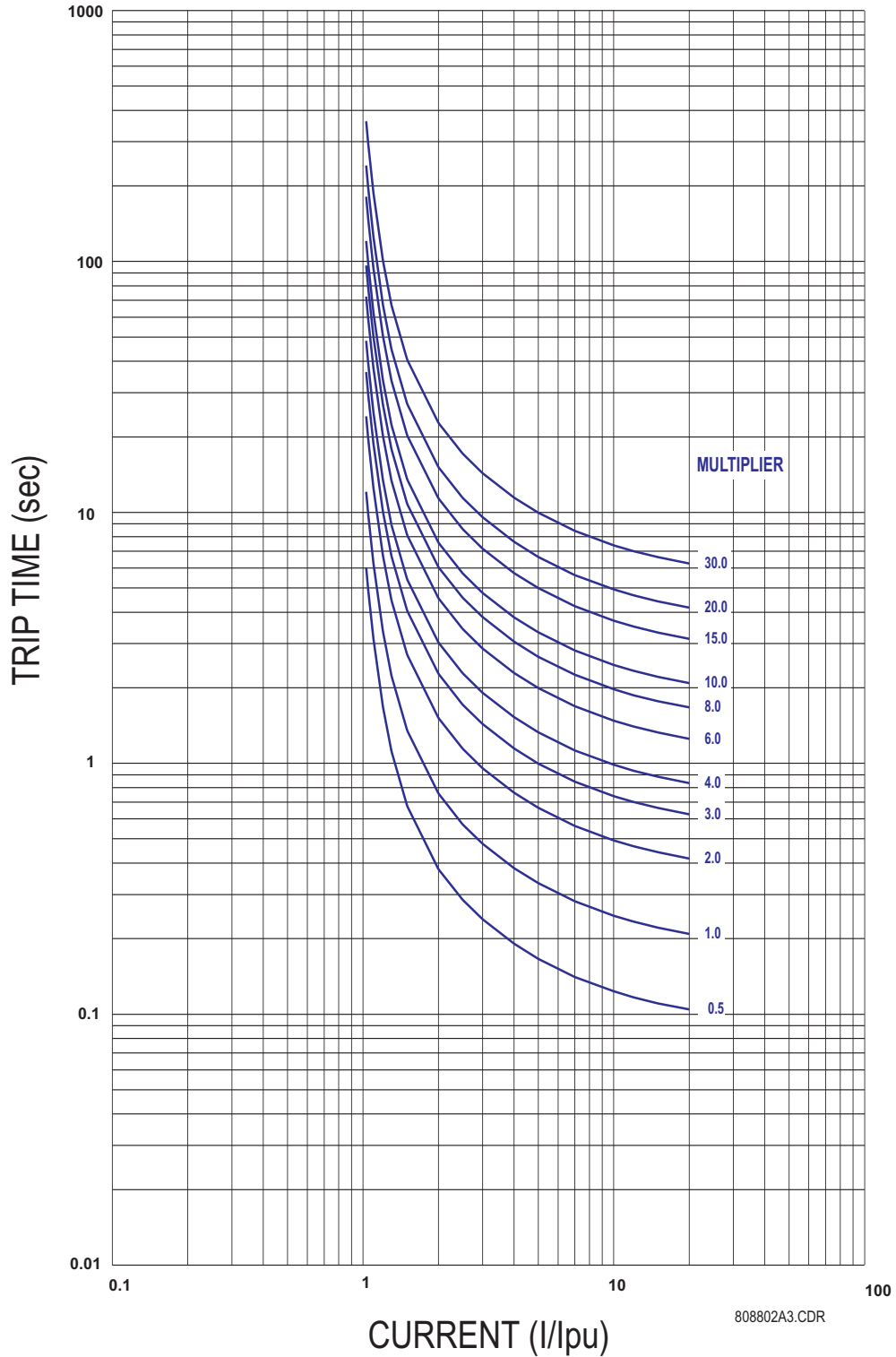

Figure C-1: ANSI MODERATELY INVERSE CURVE





GE Power Management

489 ANSI
NORMALLY INVERSE

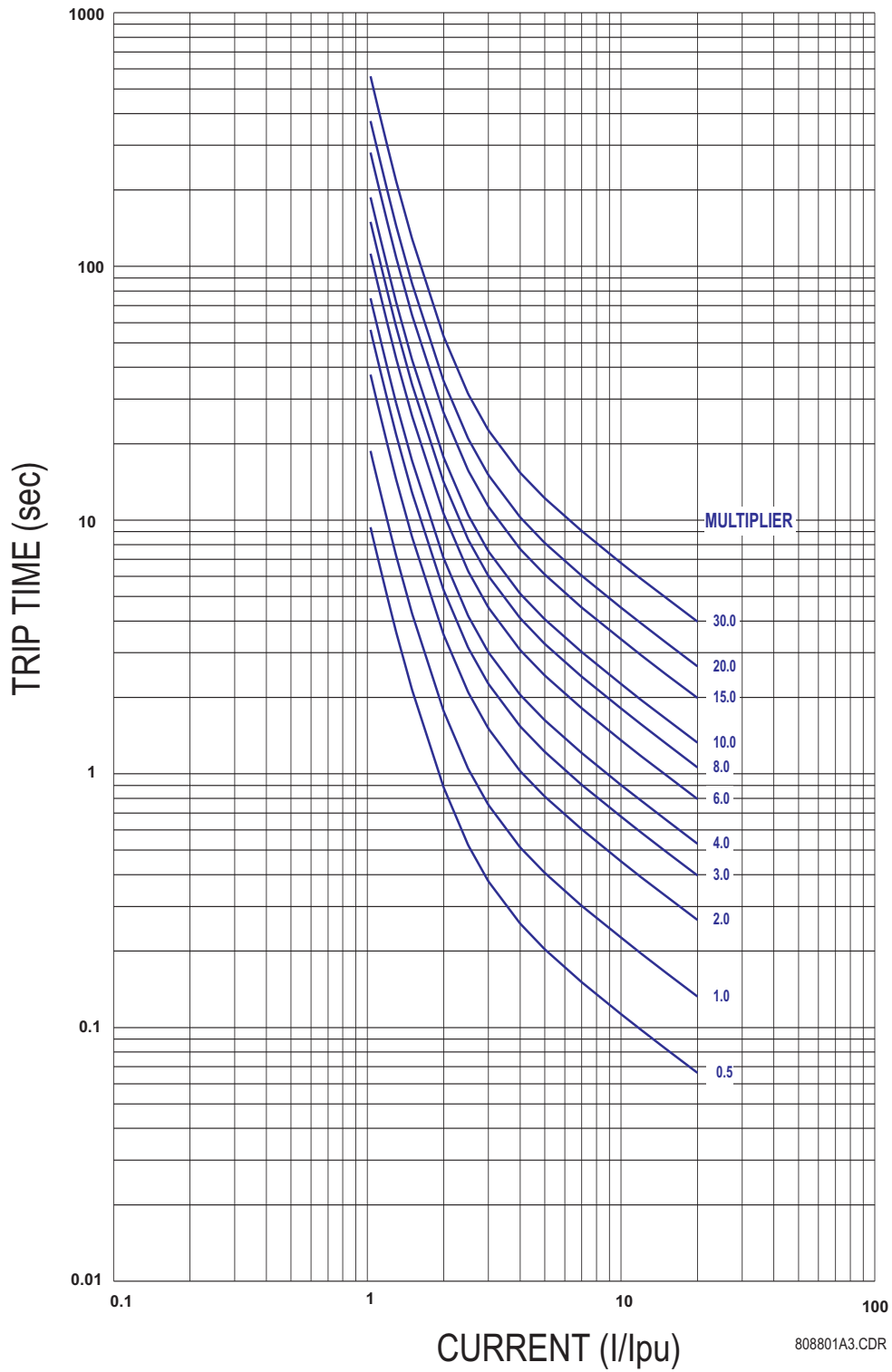

Figure C-2: ANSI NORMALLY INVERSE CURVE

C



GE Power Management

489 ANSI
VERY INVERSE

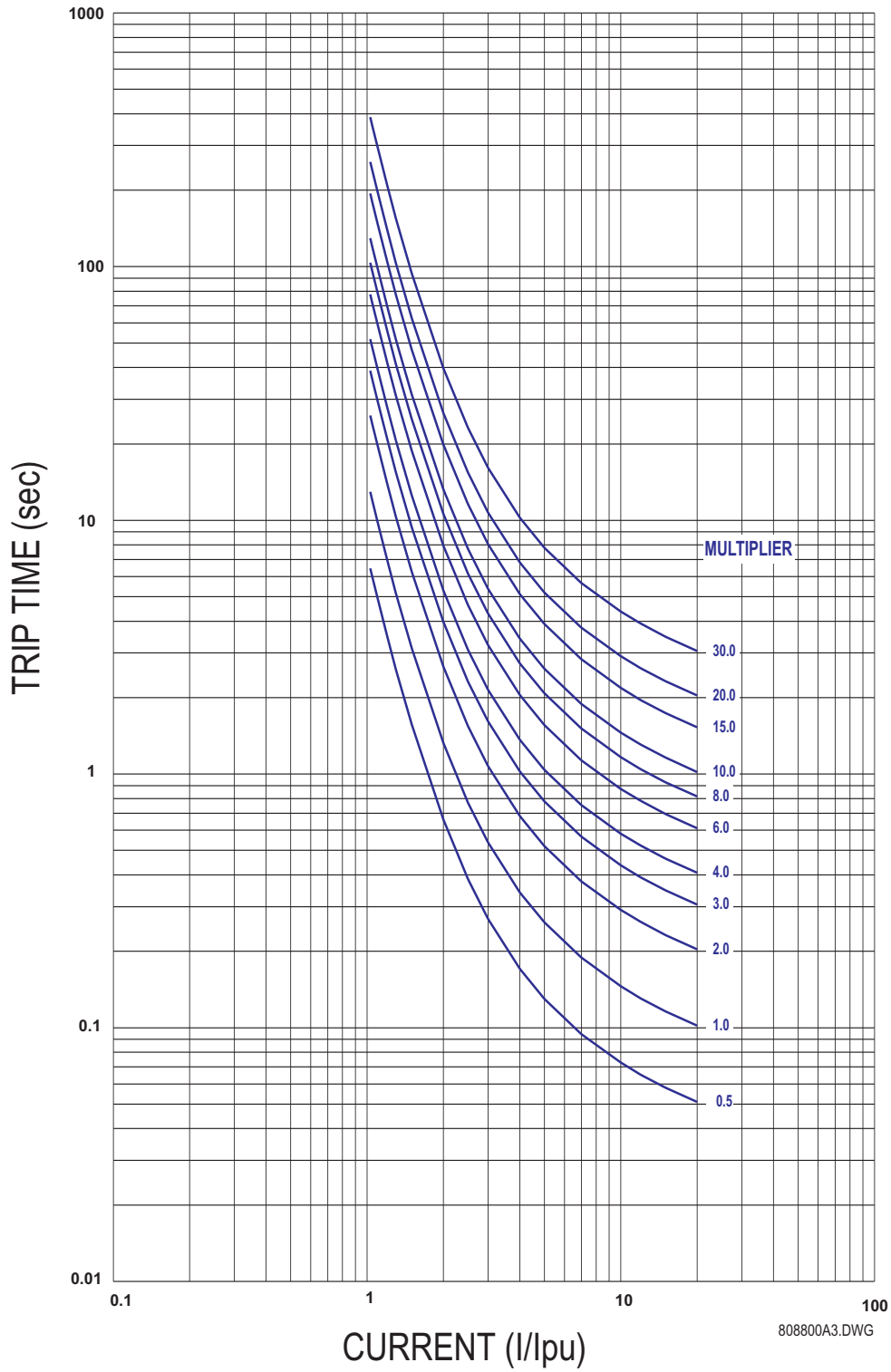

Figure C-3: ANSI VERY INVERSE CURVE





GE Power Management

489 ANSI
EXTREME INVERSE

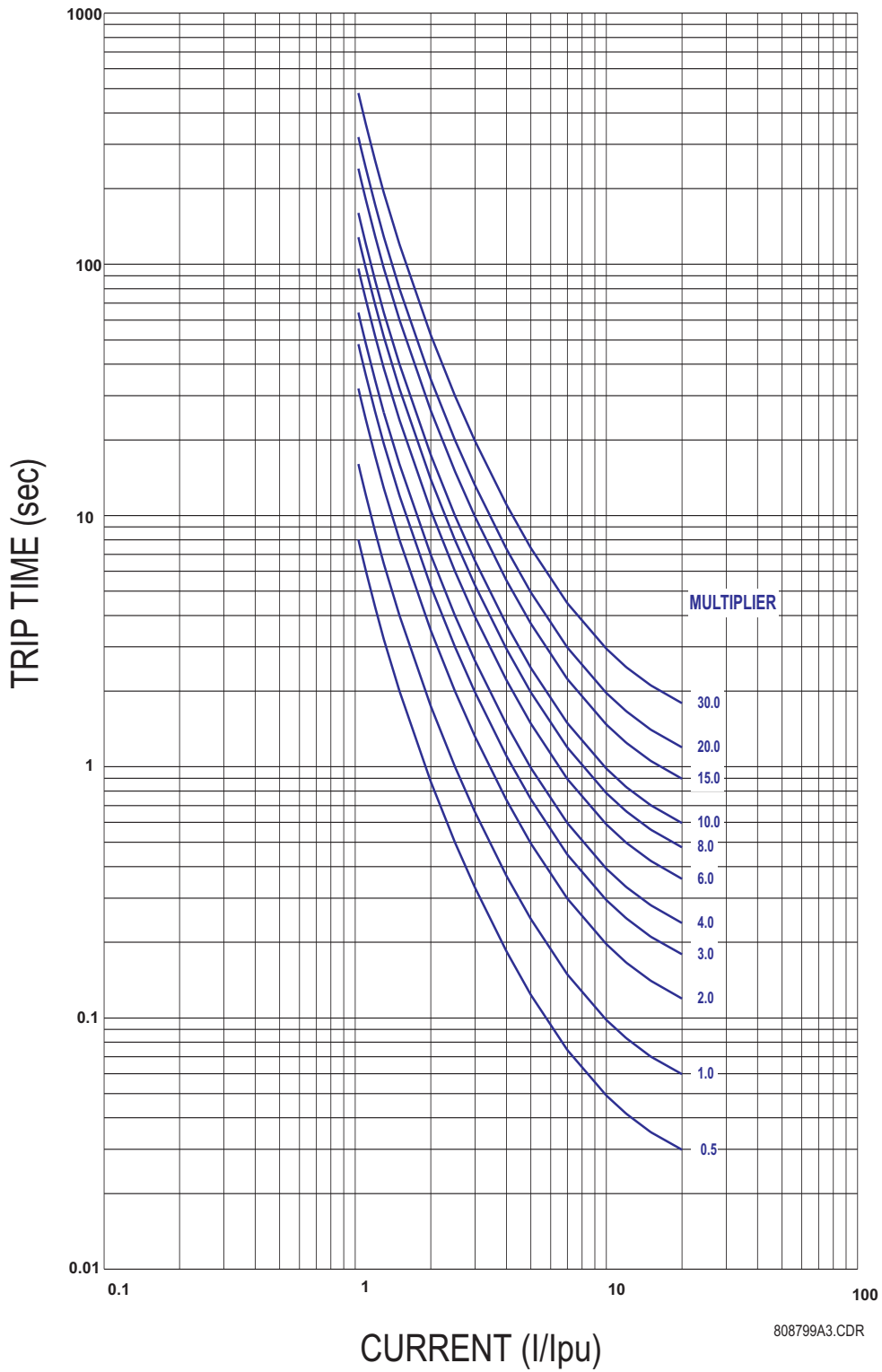

Figure C-4: ANSI EXTREMELY INVERSE CURVE

C



GE Power Management

489
DEFINITE TIME

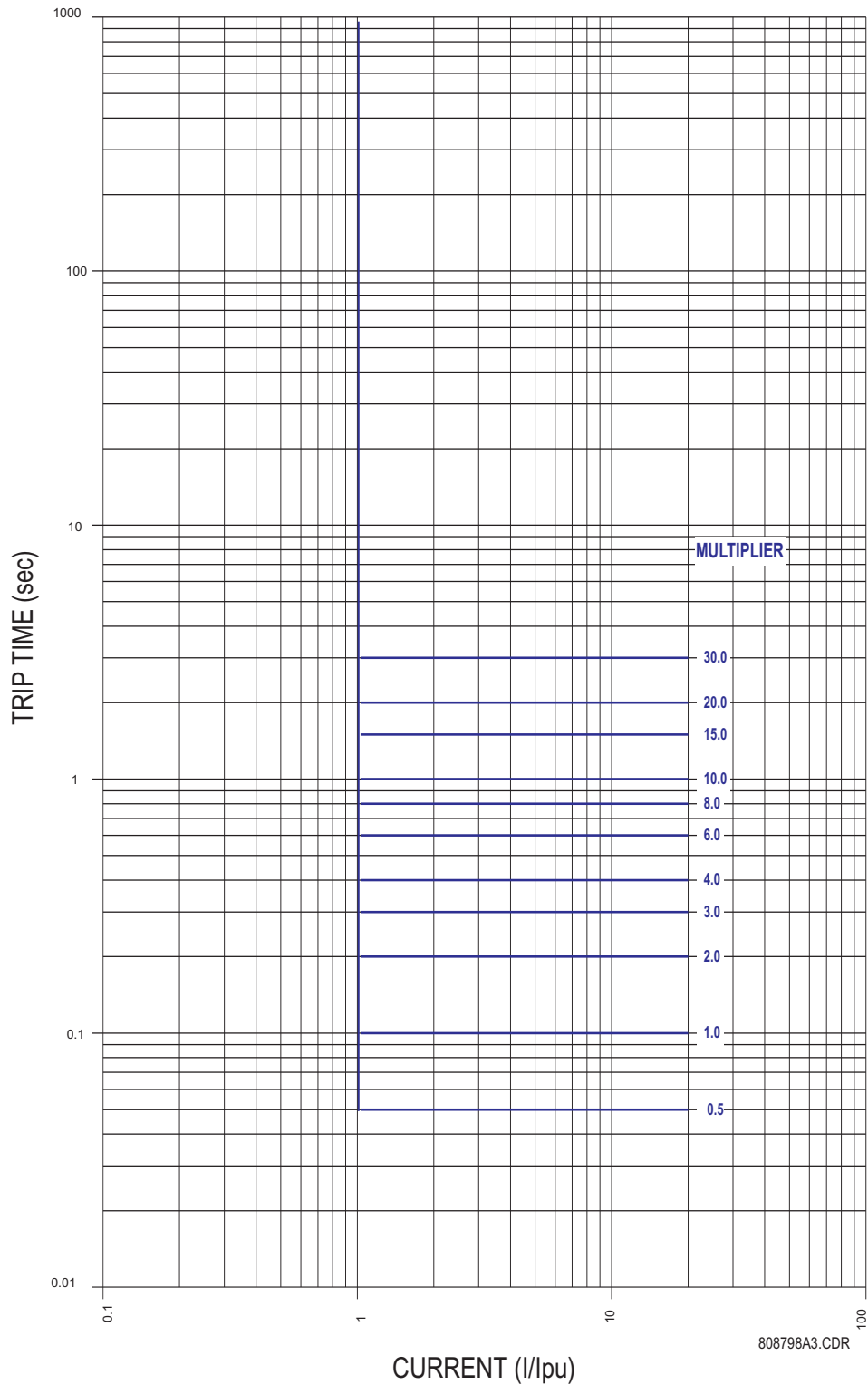

Figure C-5: DEFINITE TIME CURVE





GE Power Management

489 IAC SHORT INVERSE

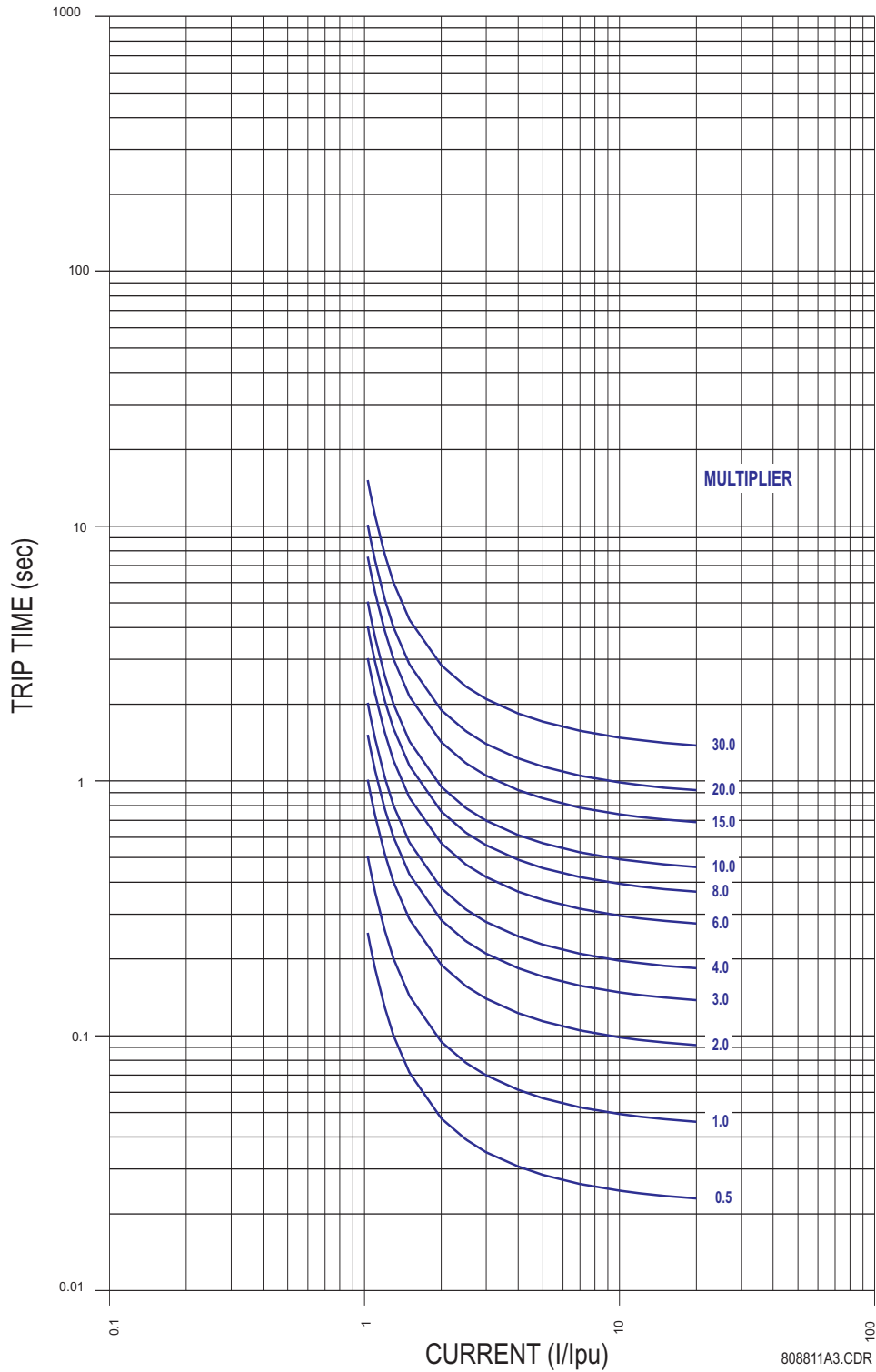

Figure C-6: IAC SHORT INVERSE CURVE

808811A3.CDR



GE Power Management

489 IAC
INVERSE

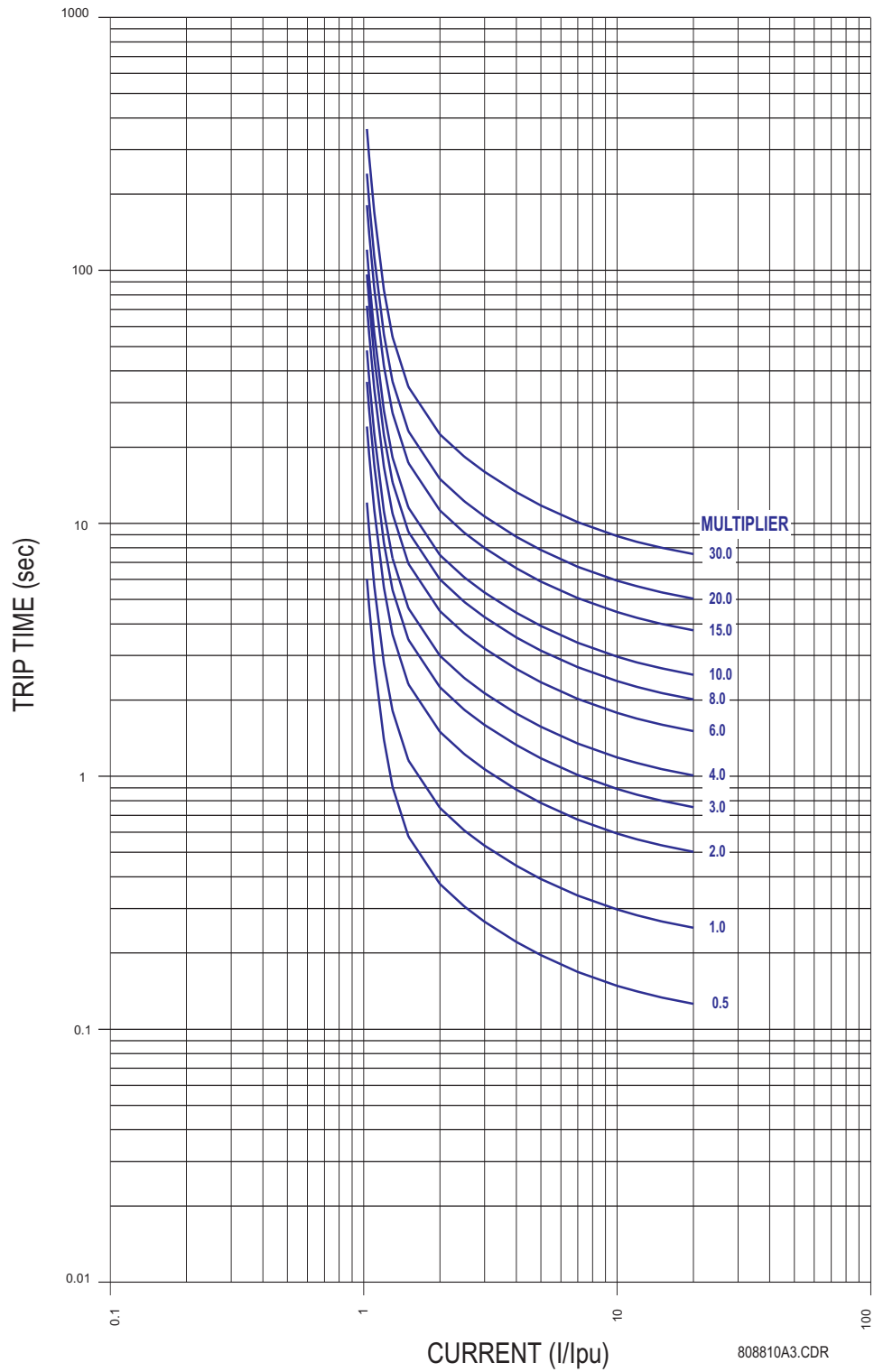

Figure C-7: IAC INVERSE CURVE

808810A3.CDR





GE Power Management

489 IAC
VERY INVERSE

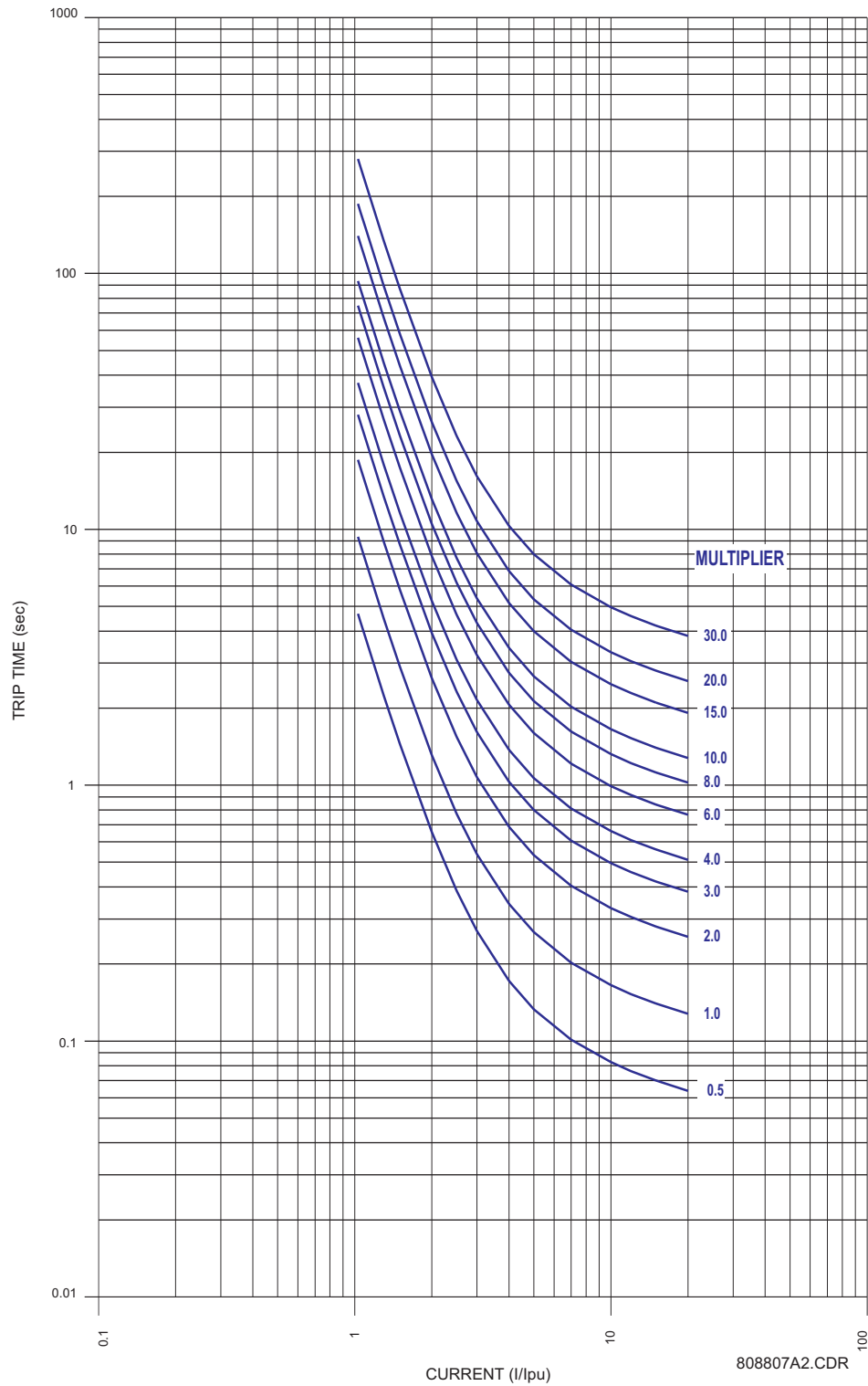

Figure C-8: IAC VERY INVERSE CURVE

C



GE Power Management

489 IAC
EXTREME INVERSE

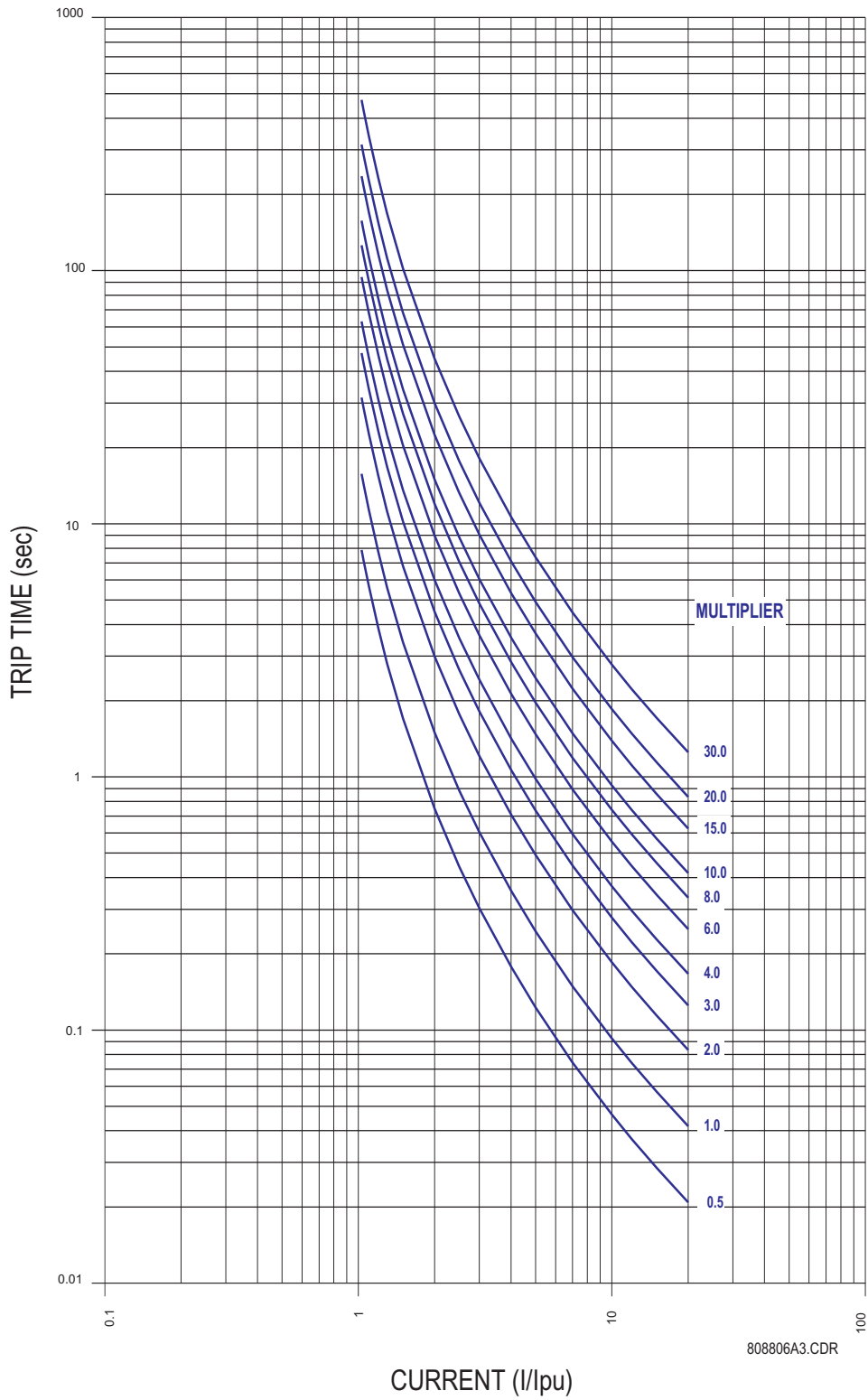

808806A3.CDR

Figure C-9: IAC EXTREME INVERSE CURVE





GE Power Management

489 IEC
CURVE A (BS142)

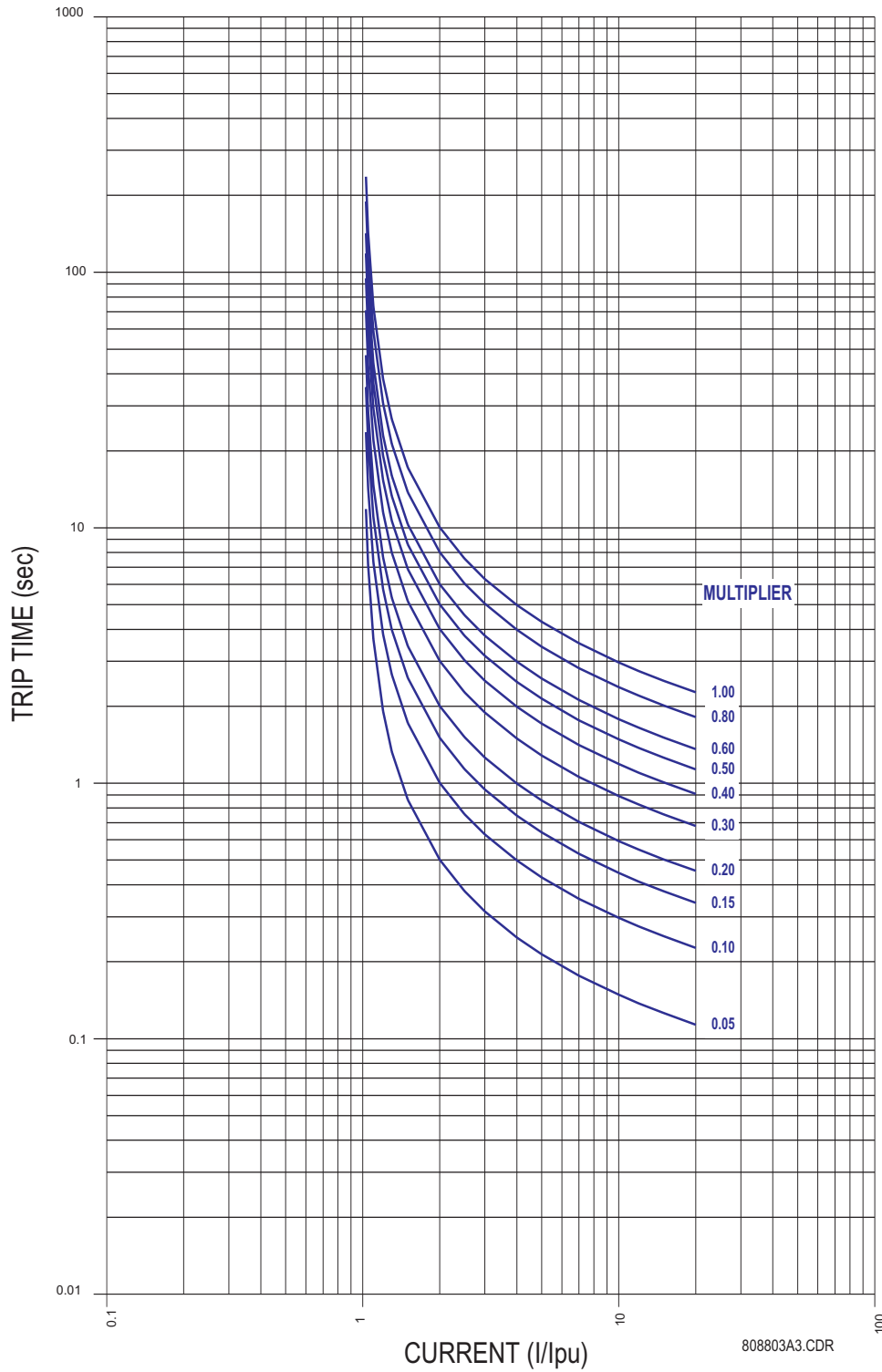

Figure C-10: IEC CURVE A (BS142)

C



GE Power Management

489 IEC
CURVE B (BS142)

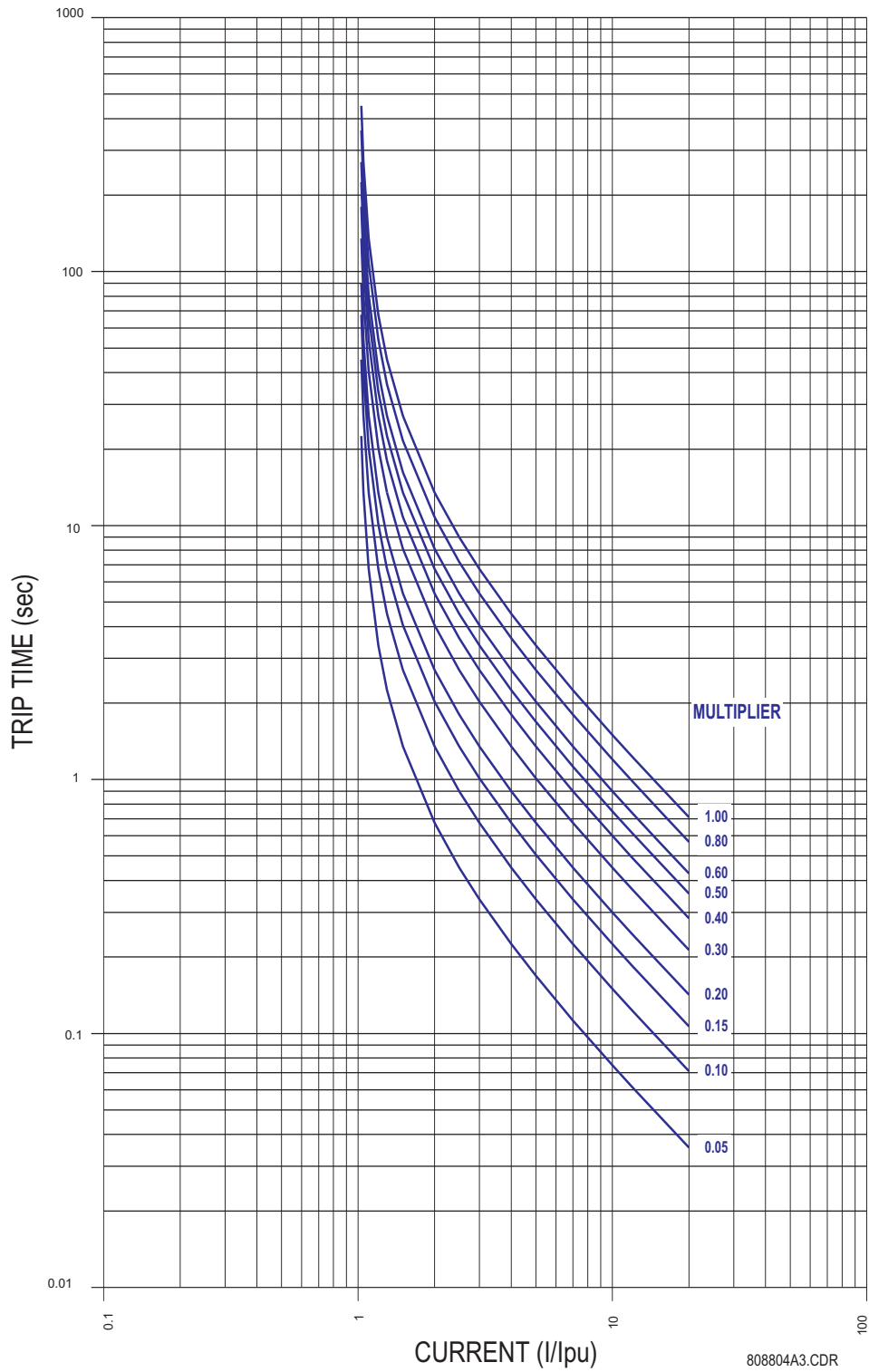

Figure C-11: IEC CURVE B (BS142)





GE Power Management

489 IEC
CURVE C (BS142)

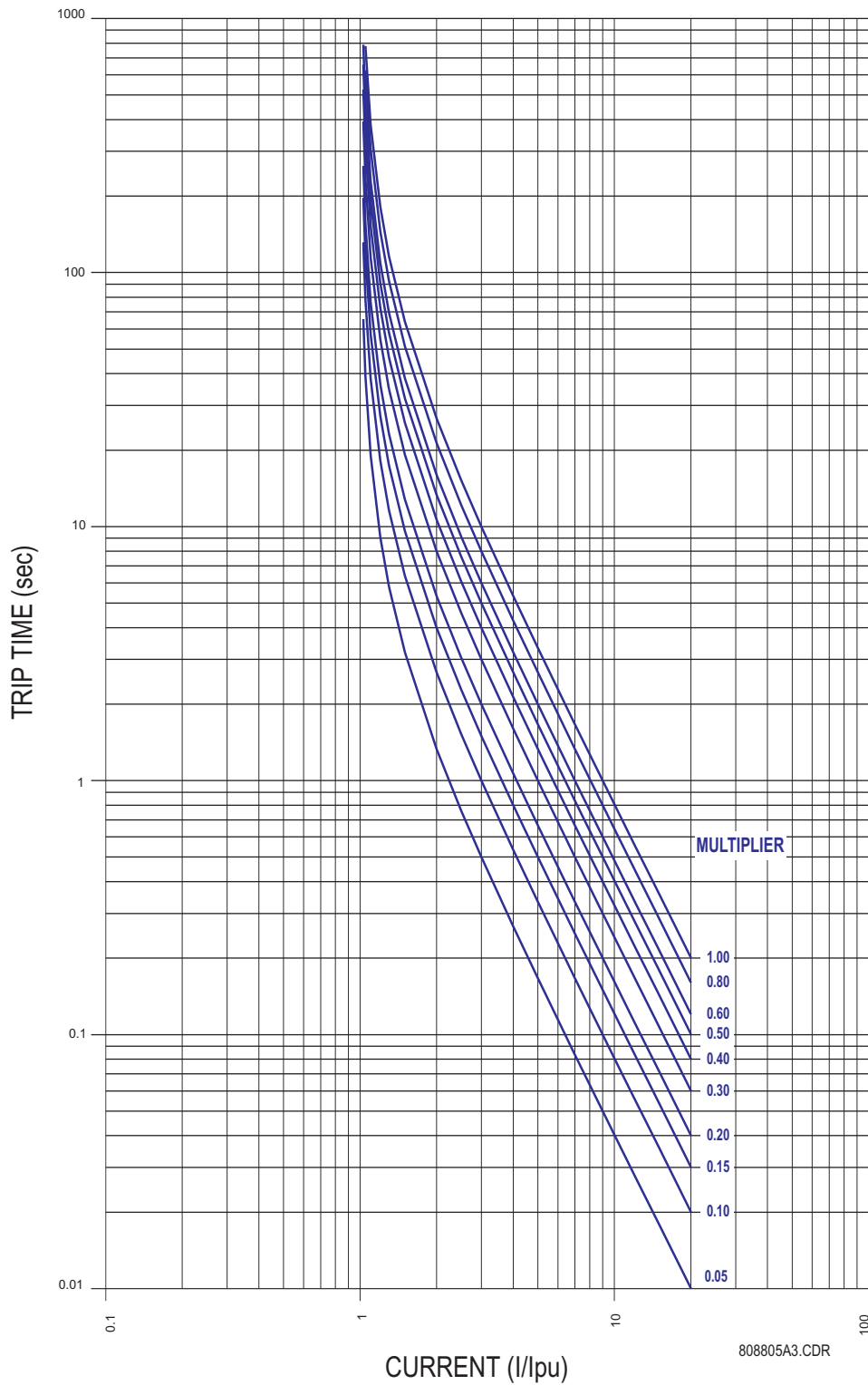

Figure C-12: IEC CURVE C (BS142)

C

D.1.1 GROUND FAULT CTs FOR 50:0.025 A CT

CTs that are specially designed to match the ground fault input of GE Power Management motor protection relays should be used to ensure correct performance. These CTs have a 50:0.025A (2000:1 ratio) and can sense low leakage currents over the relay setting range with minimum error. Three sizes are available with 3½", 5½", or 8" diameter windows.

HGF3 / HGF5

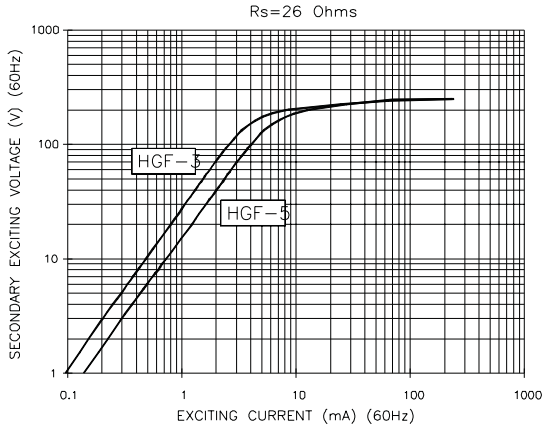

HGF8

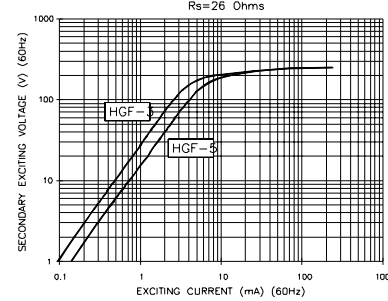

CURRENT RATIO	TURNS RATIO	SEC RES.*
50:0.025	2000:1	24.85

* OHMS AT 75° C.

This test report is in accordance with ANSI/IEEE C57.13 1993

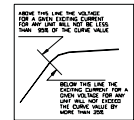

DIMENSIONS

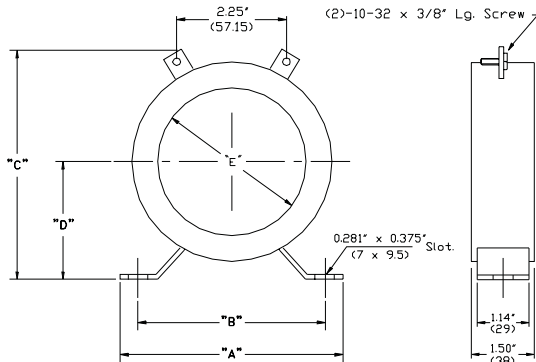

PART NO.	DIMENSIONS																	
	A		B		C						D		E					
	Min.	Nom.	Min.	Nom.	Min.	Nom.	Max.	Min.	Nom.	Max.	Min.	Nom.	Max.	Min.	Nom.	Max.		
CT-HGF5	7.80	198	7.00	178	8.40	213	8.50	216	8.60	218	4.50	114	5.50	140	5.70	145	5.90	150
CT-HGF3	6.00	152	5.25	133	5.65	144	5.75	146	5.85	149	2.90	74	3.50	89	3.70	94	3.90	99

DIMENSIONS

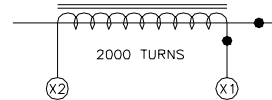
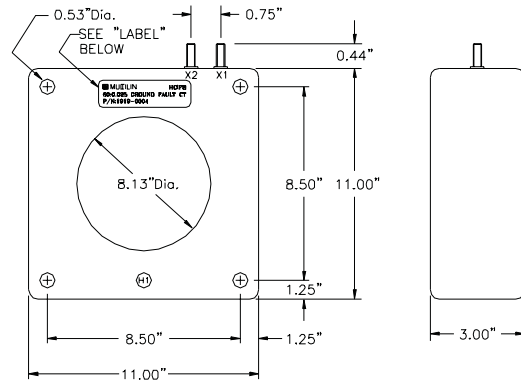

D.1.2 GROUND FAULT CTs FOR 5 A SECONDARY CT

For low resistance or solidly grounded systems, a 5 A secondary CT should be used. Two sizes are available with 5½" or 13" x 16" windows. Various Primary amp CTs can be chosen (50 to 250).

GCT5

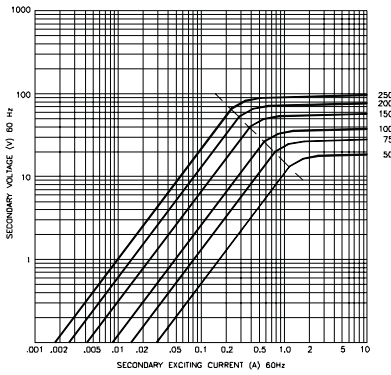

MULTIPL. NO.	CURRENT RATIO	TURNS RATIO	SEC. RES.*
X021-0251	250:5	50:1	0.097
X021-0201	200:5	40:1	0.078
X021-0151	150:5	30:1	0.058
X021-0101	100:5	20:1	0.039
X021-0076	75:5	15:1	0.029
X021-0051	50:5	10:1	0.019

* OHMS AT 75° C.

This test report is in accordance with ANSI/IEEE C57.13 1993

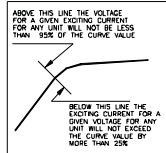

GCT16

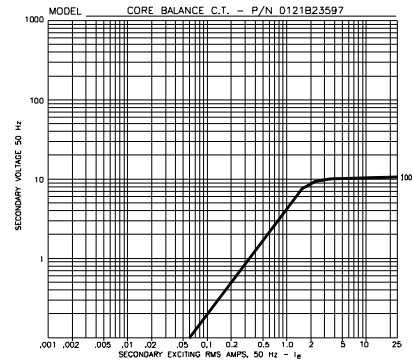

D

DIMENSIONS

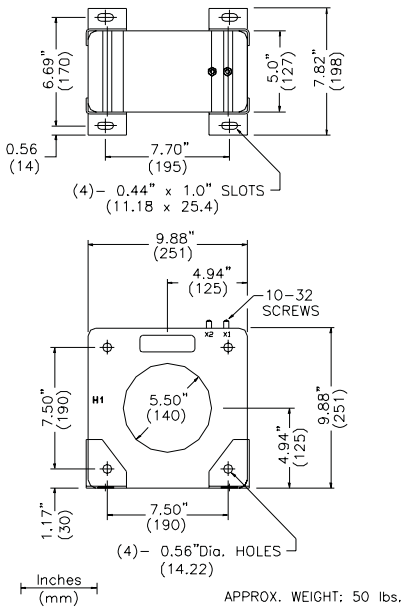

DIMENSIONS

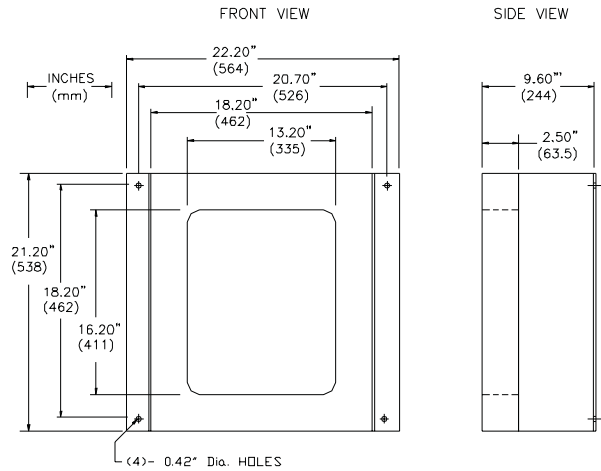

D.1.3 PHASE CTS

Current transformers in most common ratios from 50:5 to 1000:5 are available for use as phase current inputs with motor protection relays. These come with mounting hardware and are also available with 1 A secondaries. Voltage class: 600 V BIL, 10 KV.

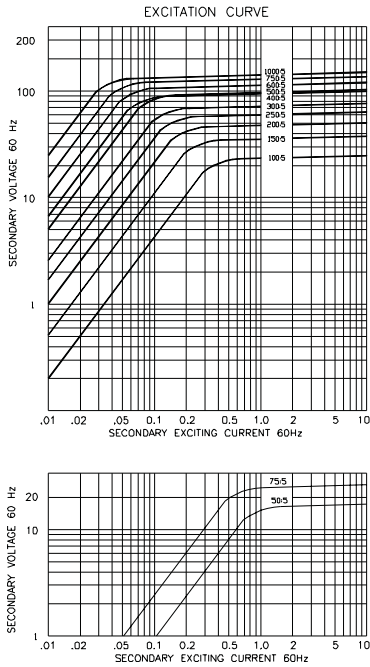

CURRENT TRANSFORMER SPECIFICATIONS				
CURRENT RATIO	WINDOW SIZE	CT CLASS	MULTILIN No.	CT Dims.
50:5	2.75"	C10	X911-0010	A
75:5	2.75"	C10	X911-0011	A
100:5	3.00"	C10	X911-0012	B
150:5	3.00"	C10	X911-0013	B
200:5	3.00"	C20	X911-0014	B
250:5	3.00"	C20	X911-0015	B
300:5	3.00"	C20	X911-0016	B
400:5	3.00"	C20	X911-0017	B
500:5	3.00"	C50	X911-0018	B
600:5	3.00"	C50	X911-0019	B
750:5	3.00"	C50	X911-0020	B
1000:5	3.75"	C50	X911-0021	B

909068A1.DWG

This test report is in accordance with ANSI/IEEE C57.13 1993

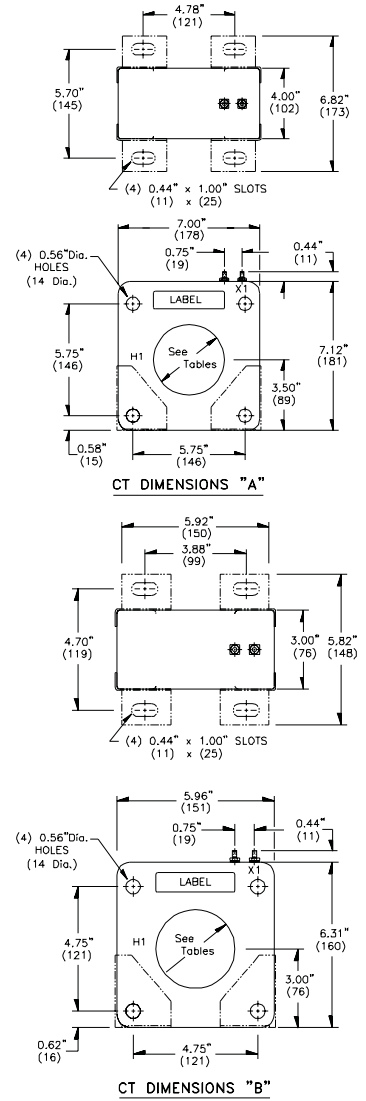
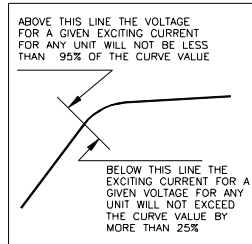

D

GE POWER MANAGEMENT RELAY WARRANTY

General Electric Power Management Inc. (GE Power Management) warrants each relay it manufactures to be free from defects in material and workmanship under normal use and service for a period of 24 months from date of shipment from factory.

In the event of a failure covered by warranty, GE Power Management will undertake to repair or replace the relay providing the warrantor determined that it is defective and it is returned with all transportation charges prepaid to an authorized service centre or the factory. Repairs or replacement under warranty will be made without charge.

Warranty shall not apply to any relay which has been subject to misuse, negligence, accident, incorrect installation or use not in accordance with instructions nor any unit that has been altered outside a GE Power Management authorized factory outlet.

GE Power Management is not liable for special, indirect or consequential damages or for loss of profit or for expenses sustained as a result of a relay malfunction, incorrect application or adjustment.

For complete text of Warranty (including limitations and disclaimers), refer to GE Power Management Standard Conditions of Sale.

E

F.1.1 LIST OF FIGURES

FIGURE 1–1: SINGLE LINE DIAGRAM.....	1-1
FIGURE 1–2: 489 ORDER CODES.....	1-3
FIGURE 2–1: 489 DIMENSIONS.....	2-1
FIGURE 2–2: DRAWOUT UNIT SEAL.....	2-1
FIGURE 2–3: CASE AND UNIT IDENTIFICATION LABELS.....	2-2
FIGURE 2–4: BEND UP MOUNTING TABS.....	2-3
FIGURE 2–5: PRESS LATCH TO DISENGAGE HANDLE.....	2-3
FIGURE 2–6: ROTATE HANDLE TO STOP POSITION.....	2-4
FIGURE 2–7: SLIDE UNIT OUT OF CASE.....	2-4
FIGURE 2–8: TERMINAL LAYOUT.....	2-5
FIGURE 2–9: TYPICAL WIRING DIAGRAM.....	2-7
FIGURE 2–10: TYPICAL WIRING (DETAIL).....	2-8
FIGURE 2–11: CONTROL POWER CONNECTION.....	2-9
FIGURE 2–13: CORE BALANCE GROUND CT INSTALLATION.....	2-10
FIGURE 2–12: RESIDUAL GROUND CT CONNECTION.....	2-10
FIGURE 2–14: LOOP POWERED TRANSDUCER CONNECTION.....	2-11
FIGURE 2–15: RTD WIRING.....	2-12
FIGURE 2–16: RS485 COMMUNICATIONS INTERFACE.....	2-14
FIGURE 2–17: TESTING THE 489 FOR DIELECTRIC STRENGTH.....	2-15
FIGURE 3–1: 489 FACEPLATE.....	3-1
FIGURE 3–2: 489 DISPLAY.....	3-2
FIGURE 3–3: 489 LED INDICATORS.....	3-2
FIGURE 3–4: RS232 PROGRAM PORT.....	3-3
FIGURE 3–5: 489 KEYPAD.....	3-4
FIGURE 4–1: INADVERTENT ENERGIZATION.....	4-21
FIGURE 4–2: VOLTAGE RESTRAINT CHARACTERISTIC.....	4-23
FIGURE 4–3: NEGATIVE SEQUENCE INVERSE TIME CURVES.....	4-24
FIGURE 4–4: DIFFERENTIAL ELEMENTS.....	4-26
FIGURE 4–5: GROUND DIRECTIONAL DETECTION.....	4-28
FIGURE 4–6: NEUTRAL OVERVOLTAGE DETECTION.....	4-36
FIGURE 4–7: LOSS OF EXCITATION R-X DIAGRAM.....	4-39
FIGURE 4–8: DISTANCE ELEMENT SETUP.....	4-40
FIGURE 4–9: POWER MEASUREMENT CONVENTIONS.....	4-41
FIGURE 4–10: TYPICAL TIME-CURRENT AND THERMAL LIMIT CURVES (ANSI/IEEE C37.96).....	4-51
FIGURE 4–11: 489 STANDARD OVERLOAD CURVES.....	4-54
FIGURE 4–12: CUSTOM CURVE EXAMPLE.....	4-56
FIGURE 4–13: THERMAL LIMITS FOR HIGH INERTIAL LOAD.....	4-57
FIGURE 4–14: VOLTAGE DEPENDENT OVERLOAD CURVES.....	4-58
FIGURE 4–15: VOLTAGE DEPENDENT OVERLOAD PROTECTION CURVES.....	4-59
FIGURE 4–16: VOLTAGE DEPENDENT O/L PROTECTION AT 80% AND 100% VOLTAGE.....	4-60
FIGURE 4–17: THERMAL MODEL COOLING.....	4-62
FIGURE 4–18: RTD BIAS CURVE.....	4-64
FIGURE 4–19: TRIP COIL SUPERVISION.....	4-66
FIGURE 4–20: VT FUSE FAILURE.....	4-66
FIGURE 4–21: ROLLING DEMAND (15 MINUTE WINDOW).....	4-68
FIGURE 4–22: PULSE OUTPUT.....	4-69
FIGURE 7–1: SECONDARY INJECTION TEST SETUP.....	7-2
FIGURE 7–2: SECONDARY INJECTION SETUP #2.....	7-12
FIGURE 7–3: PHASE DIFFERENTIAL.....	7-14
FIGURE 7–4: SECONDARY INJECTION TEST SETUP #3.....	7-15
FIGURE 8–1: GE POWER MANAGEMENT WELCOME SCREEN.....	8-3
FIGURE 8–2: COMMUNICATION/COMPUTER DIALOG BOX.....	8-4
FIGURE 8–3: GRAPH ATTRIBUTE WINDOW – TRENDING.....	8-10
FIGURE 8–4: TRENDING.....	8-11
FIGURE 8–5: TRENDING FILE SETUP.....	8-11
FIGURE 8–6: WAVEFORM CAPTURE.....	8-12
FIGURE 8–7: PHASORS.....	8-13
FIGURE 8–8: 489PC EVENT RECORDER.....	8-14
FIGURE B–1: STATOR GROUND FAULT PROTECTION.....	B-1
FIGURE B–2: PARALLEL GENERATORS WITH COMMON GROUNDING IMPEDANCE.....	B-2
FIGURE B–3: GROUND OVERCURRENT ELEMENT WITH DIFFERENT CURRENT SOURCE SIGNALS.....	B-3
FIGURE B–4: GROUND DIRECTIONAL ELEMENT CONCEPTUAL ARRANGEMENT.....	B-4

FIGURE B-5: GROUND DIRECTIONAL ELEMENT POLARITIES AND PLANE OF OPERATION..... B-5
 FIGURE C-1: ANSI MODERATELY INVERSE CURVE..... C-1
 FIGURE C-2: ANSI NORMALLY INVERSE CURVE..... C-2
 FIGURE C-3: ANSI VERY INVERSE CURVE..... C-3
 FIGURE C-4: ANSI EXTREMELY INVERSE CURVE..... C-4
 FIGURE C-5: DEFINITE TIME CURVE..... C-5
 FIGURE C-6: IAC SHORT INVERSE CURVE..... C-6
 FIGURE C-7: IAC INVERSE CURVE..... C-7
 FIGURE C-8: IAC VERY INVERSE CURVE..... C-8
 FIGURE C-9: IAC EXTREME INVERSE CURVE..... C-9
 FIGURE C-10: IEC CURVE A (BS142)..... C-10
 FIGURE C-11: IEC CURVE B (BS142)..... C-11
 FIGURE C-12: IEC CURVE C (BS142)..... C-12

F.1.2 LIST OF TABLES

TABLE: 1-1 TRIP AND ALARM PROTECTION FEATURES..... 1-2
 TABLE: 1-2 METERING AND ADDITIONAL FEATURES..... 1-2
 TABLE: 2-1 489 TERMINAL LIST..... 2-6
 TABLE: 4-1 489 OVERCURRENT CURVE TYPES..... 4-17
 TABLE: 4-2 ANSI INVERSE TIME CURVE CONSTANTS..... 4-17
 TABLE: 4-3 IEC (BS) INVERSE TIME CURVE CONSTANTS..... 4-18
 TABLE: 4-4 IAC INVERSE TIME CURVE CONSTANTS..... 4-18
 TABLE: 4-5 FLEXCURVE™ TABLE..... 4-19
 TABLE: 4-6 RTD TEMPERATURE VS. RESISTANCE..... 4-45
 TABLE: 4-7 489 STANDARD OVERLOAD CURVE MULTIPLIERS..... 4-55
 TABLE: 4-8 ANALOG OUTPUT PARAMETER SELECTION..... 4-71
 TABLE: 5-1 CAUSE OF EVENT TABLE..... 5-24
 TABLE: 5-2 FLASH MESSAGES..... 5-27
 TABLE: 6-1 489 MEMORY MAP..... 6-11
 TABLE: 6-2 DATA FORMATS..... 6-40
 TABLE: 6-3 IMPLEMENTATION TABLE..... 6-47
 TABLE: 6-4 DEFAULT VARIATIONS..... 6-48
 TABLE: 7-1 NEUTRAL AND GROUND CURRENT TEST..... 7-4
 TABLE: 7-2 DIFFERENTIAL CURRENT TEST..... 7-4
 TABLE: 7-3 ANALOG INPUT/OUTPUT TEST, 4 TO 20 MA INPUT..... 7-7
 TABLE: 7-4 ANALOG INPUT/OUTPUT TEST, 0 TO 1 MA INPUT..... 7-8
 TABLE: 7-5 OUTPUT RELAYS..... 7-8
 TABLE: A-1 SETPOINTS PAGE 1 – 489 SETUP..... A-1
 TABLE: A-2 SETPOINTS PAGE 2 – SYSTEM SETUP..... A-1
 TABLE: A-3 SETPOINTS PAGE 3 – DIGITAL INPUTS..... A-2
 TABLE: A-4 SETPOINTS PAGE 4 – OUTPUT RELAYS..... A-4
 TABLE: A-5 SETPOINTS PAGE 5 – CURRENT ELEMENTS..... A-5
 TABLE: A-6 SETPOINTS PAGE 6 – VOLTAGE ELEMENTS..... A-12
 TABLE: A-7 SETPOINTS PAGE 7 – POWER ELEMENTS..... A-15
 TABLE: A-8 SETPOINTS PAGE 8 – RTD TEMPERATURE (SETPOINT GROUP 1)..... A-16
 TABLE: A-9 SETPOINTS PAGE 8 – RTD TEMPERATURE (SETPOINT GROUP 2)..... A-17
 TABLE: A-10 SETPOINTS PAGE 9 – THERMAL MODEL..... A-18
 TABLE: A-11 SETPOINTS PAGE 10 – MONITORING..... A-20
 TABLE: A-12 SETPOINTS PAGE 11 – ANALOG INPUT/OUTPUT..... A-21
 TABLE: B-1 DETECTION ELEMENT STATUS..... B-5



Numerics

0-1mA ANALOG INPUT 2-12
 4-20mA ANALOG INPUT 2-12
 489PC
 see SOFTWARE
 50:0.025 CT 2-10

A

ACCESS SWITCH 4-10
 ACCESSORIES 1-3
 ACTUAL VALUES
 messages 5-1
 printing 8-9
 software 8-9
 ALARM PICKUPS 5-8
 ALARM RELAY 2-13, 4-16
 ALARM STATUS 5-3
 ALARMS 4-1
 ANALOG IN MIN/MAX 5-18
 ANALOG INPUTS 2-11
 actual values 5-16, 5-18
 analog I/P min/max 4-7
 DNP point list 6-53
 min/max 5-18
 minimums and maximums 4-12
 setpoints 4-71
 specifications 1-4
 testing 7-7
 ANALOG OUTPUTS 2-12
 setpoints 4-70
 specifications 1-5
 table 4-71
 testing 7-7
 ANSI CURVES 4-17, C-1
 ANSI DEVICE NUMBERS 1-1
 AUXILIARY RELAY 2-13, 4-16

B

BAUD RATE 1-4, 4-4, 6-1
 BINARY COUNTER DNP POINTS 6-52
 BINARY INPUTS DNP POINTS 6-49
 BINARY OUTPUTS DNP POINTS 6-51
 BREAKER FAILURE 4-65
 BREAKER STATUS 4-10
 BURDEN 1-4

C

CALIBRATION INFO 5-25
 CASE 1-8, 2-1
 CERTIFICATIONS 1-8
 CLEAR DATA 4-7
 CLOCK 4-5, 5-11
 COMM PORT MONITOR 4-76
 COMMISSIONING A-1
 COMMUNICATIONS
 configuration 8-4
 data frame format 6-1
 data rate 6-1
 error responses 6-8
 monitoring 4-76
 passcode 6-10
 setpoints 4-4

 specifications 1-4
 CONTROL FEATURES 4-1
 CONTROL POWER 2-9
 COOLING 4-62
 COOLING TIME CONSTANTS 4-62
 CORE BALANCE 2-10
 CRC-16 6-2, 6-3
 CT RATIO 4-8
 CTs
 burden 1-4
 ground fault D-1, D-2
 phase D-3
 setpoints 4-8
 withstand 1-4
 CURRENT ACCURACY TEST 7-3
 CURRENT DEMAND 4-67
 CURRENT INPUTS 1-4
 CURRENT METERING 5-12
 CURRENT SENSING 4-8
 CURRENT TRANSFORMERS
 see CTs
 CURVES
 see OVERLOAD CURVES
 CUSTOM OVERLOAD CURVE 4-56
 CYCLIC REDUNDANCY CHECK
 see CRC-16

D

DATA FRAME FORMAT 6-1
 DATA PACKET FORMAT 6-1
 DATA RATE 6-1
 DEFAULT MESSAGES 4-4, 4-5, 4-6
 DEFAULT VARIATIONS 6-48
 DEFINITE TIME CURVE 4-19, C-5
 DEMAND DATA 4-12
 DEMAND METERING 1-5, 4-67, 5-16
 DEMAND PERIOD 4-68
 DESCRIPTION 1-1
 DEVICE NUMBERS 1-1
 DIAGNOSTIC MESSAGES 5-26
 DIELECTRIC STRENGTH
 specifications 1-8
 testing 2-15
 DIFFERENTIAL CURRENT ACCURACY TEST 7-4
 DIGITAL COUNTER 4-12
 DIGITAL INPUTS 2-11
 actual values 5-11
 dual setpoints 4-12
 field-breaker discrepancy 4-14
 general input 4-11
 ground switch status 4-15
 remote reset 4-12
 sequential trip 4-13
 specifications 1-4
 tachometer 4-14
 test input 4-12
 testing 7-7
 thermal reset 4-12
 DIMENSIONS 2-1
 DISPLAY 3-2
 DISTANCE ELEMENTS 4-39
 DNP
 device profile document 6-45
 implementation table 6-47
 point lists 6-49, 6-51, 6-52
 setpoints 4-4
 DRAWOUT INDICATOR 2-13
 DUAL SETPOINTS 4-2, 4-12, 6-10

E

ELECTRICAL INTERFACE 6-1
 EMERGENCY RESTARTS 4-12
 ENTERING +/- SIGNS 3-4
 ENTERING ALPHANUMERIC TEXT 3-4
 ENVIRONMENT 1-7
 ERROR RESPONSES 6-8
 EVENT RECORDER 4-7, 4-12, 5-22, 6-9, 8-14

F

FACEPLATE 3-1
 FACTORY SERVICE 4-76
 FAULT SETUP 4-75
 FEATURES 1-1, 1-2, 1-7
 FIELD-BREAKER DISCREPANCY 1-5
 FIGURES F-1
 FIRMWARE, UPGRADING 8-6
 FLASH MESSAGES 5-27
 FLEXCURVE 4-19
 FLOW 2-11
 FREQUENCY TRACKING 1-4
 FUSE 1-8

G

GENERAL COUNTERS 5-21
 GENERAL INPUTS 1-5, 4-11
 GENERATOR INFORMATION 4-7
 GENERATOR LOAD 5-17
 GENERATOR PARAMETERS 4-9
 GENERATOR STATUS 5-2
 GROUND CT
 burden 1-4
 setpoint 4-8
 withstand 1-4
 GROUND CURRENT ACCURACY TEST 7-4, 7-13
 GROUND CURRENT INPUT 2-10
 GROUND DIRECTIONAL 4-27, B-4
 GROUND FAULT CTs D-1, D-2
 GROUND OVERCURRENT 4-25, B-3
 GROUND SWITCH STATUS 4-15

H

HIGH-SET PHASE OVERCURRENT 4-28
 HI-POT 2-15
 HOT/COLD CURVE RATIO 4-63

I

IAC CURVES 4-18, C-6
 IDENTIFICATION 2-2
 IEC CURVES 4-18, C-10
 INADVERTENT ENERGIZATION 1-6, 4-21
 INJECTION TEST SETUP 7-2, 7-12, 7-15
 INPUTS
 analog 1-4, 2-11
 current 1-4, 2-9, 2-10
 digital 1-4, 2-11
 general 1-5
 RTD 1-4, 2-12

 voltage 1-4, 2-11
 INSERTION 2-3
 INSTALLATION 2-3
 IRIG-B 2-13, 4-5

K

KEYPAD 3-4

L

LAST TRIP DATA 4-7, 4-12, 5-2, 5-5, 5-8
 LEARNED PARAMETERS 4-12
 LEDs 3-2, 3-3
 LIST OF FIGURES F-1
 LIST OF TABLES F-2
 LOOP POWERED TRANSDUCERS 2-11
 LOOPBACK TEST 6-6
 LOSS OF EXCITATION 1-7, 4-38
 LOSS OF LOAD 3-3
 LOW FORWARD POWER 4-44

M

MACHINE COOLING 4-62
 MEMORY MAP
 data formats 6-40
 description 6-9
 information 6-9
 Modbus 6-11
 user-definable 6-9
 MESSAGE SCRATCHPAD 4-6
 METERING
 current 5-12
 demand 1-5, 5-16
 Mvarh 4-7, 4-12, 5-14
 MWh 4-7, 4-12, 5-14
 power 1-5, 5-14
 specifications 1-2
 voltage 5-13
 MODBUS
 description 6-1
 execute operation 6-5
 function code 03 6-4
 function code 04 6-4
 function code 05 6-5
 function code 06 6-5
 function code 07 6-6
 function code 08 6-6
 function code 16 6-7
 loopback test 6-6
 performing commands 6-8
 read actual values 6-4
 read device status 6-6
 read setpoints 6-4
 store multiple setpoints 6-7
 store single setpoint 6-5
 MODBUS FUNCTIONS 6-4
 MODEL INFORMATION 5-25
 MODEL SETUP 4-52
 MOTOR STARTS 4-12
 MOTOR TRIPS 4-12
 MVA DEMAND 4-67, 5-16
 MVAR DEMAND 4-67, 5-16
 Mvarh METERING 4-7, 4-12, 5-14
 MW DEMAND 4-67, 5-16
 MWh METERING 4-7, 4-12, 5-14

N

NEGATIVE SEQUENCE CURRENT ACCURACY TEST 7-5
 NEGATIVE SEQUENCE OVERCURRENT 4-23
 NEGATIVE-SEQUENCE CURRENT 5-12
 NEUTRAL CURRENT ACCURACY TEST 7-4
 NEUTRAL OVERVOLTAGE 4-35, B-1
 NEUTRAL UNDERVOLTAGE 4-36
 NEUTRAL VOLTAGE ACCURACY TEST 7-4, 7-13

O

OFFLINE OVERCURRENT 4-20
 OPEN DELTA 2-11
 OPEN DELTA CONNECTED VTs 4-37
 OPEN RTD SENSOR 4-49
 ORDER CODES 1-4
 OUTPUT CURRENT ACCURACY TEST 7-3
 OUTPUT RELAY LEDs 3-3
 OUTPUT RELAYS
 R1 TRIP 2-13
 R2 AUXILIARY 2-13
 R3 AUXILIARY 2-13
 R4 ALARM 2-13
 R6 SERVICE 2-13
 setpoints 4-16
 specifications 1-5
 testing 7-8
 wiring 2-13
 OUTPUTS
 analog 1-5, 2-12
 OVERCURRENT
 ground 4-25
 ground directional 4-27
 high-set 4-28
 negative-sequence 4-23
 phase 4-22
 phase differential 4-26
 setpoints 4-20
 specifications 1-6
 TOC 4-17
 OVERCURRENT ALARM 4-20
 OVERCURRENT CURVES
 characteristics 4-17
 IAC 4-18
 IEC 4-18
 OVERFREQUENCY 1-6, 4-34
 OVERLOAD CURVES
 custom 4-56
 definite time 4-19
 testing 7-9
 OVERVOLTAGE 1-6, 4-30

P

PACKAGING 1-8
 PARAMETER AVERAGES 5-17
 PARITY 4-4
 PASSCODE 3-5, 4-3
 PEAK DEMAND 4-7, 5-16
 PHASE CT PRIMARY 4-8, 4-9
 PHASE CTs D-3
 PHASE CURRENT INPUTS 2-9
 PHASE DIFFERENTIAL 4-26
 PHASE DIFFERENTIAL TRIP TEST 7-14
 PHASE OVERCURRENT 4-22
 PHASE REVERSAL 4-32
 PHASE REVERSAL TEST 7-12
 PHASORS 8-13

POSITIVE-SEQUENCE CURRENT 5-12
 POWER DEMAND 4-67
 POWER MEASUREMENT CONVENTIONS 4-41
 POWER MEASUREMENT TEST 7-10
 POWER METERING 1-5, 1-7, 5-14
 POWER SUPPLY 1-4, 2-9
 POWER SYSTEM 4-9
 PRE-FAULT SETUP 4-74
 PREFERENCES 4-3
 PRESSURE 2-11
 PRODUCT IDENTIFICATION 2-2
 PRODUCTION TESTS 1-8
 PROGRAM PORT 3-3
 PROTECTION FEATURES 1-2
 PROXIMITY PROBE 2-11
 PULSE OUTPUT 1-7, 4-69

R

REACTIVE POWER 4-42
 REACTIVE POWER TEST 7-11
 REAL TIME CLOCK 4-5, 5-11
 RELAY ASSIGNMENT PRACTICES 4-1
 RELAY RESET MODE 4-16
 REMOTE RESET 4-12
 RESETTING THE 489 4-16
 RESIDUAL GROUND CONNECTION 2-10
 REVERSE POWER 4-43
 RS232 COMMUNICATIONS 3-3, 4-4, 6-1
 RS485 COMMUNICATIONS 2-14, 4-4, 6-1
 RTD
 actual values 5-15, 5-17
 maximums 4-7, 4-12, 5-17
 sensor connections 2-12
 setpoints 4-46, 4-47, 4-48, 4-49
 specifications 1-4, 1-7
 testing 7-6
 RTD ACCURACY TEST 7-6
 RTD BIAS 4-63
 RTD MAXIMUMS 5-17
 RTD SENSOR, OPEN 4-49
 RTD SHORT/LOW TEMPERATURE 4-50
 RTD TYPES 4-45
 RUNNING HOUR SETUP 4-69
 RUNNING HOURS 4-12

S

SEQUENTIAL TRIP 1-5, 4-13
 SERIAL PORTS 4-4
 SERIAL START/STOP INITIATION 4-9
 SERVICE RELAY 2-13
 SETPOINT ENTRY 3-5
 SETPOINT MESSAGE MAP 4-2
 SETPOINTS
 commissioning A-1
 dual setpoints 4-2
 entering through software 8-7
 loading from a file 8-7
 messages 4-2
 printing 8-9
 saving to a file 8-5
 tables A-1
 upgrading setpoint files 8-9
 SIMULATION MODE 4-73
 SINGLE LINE DIAGRAM 1-1
 SOFTWARE
 configuration 8-4
 installation 8-2

INDEX

loading setpoints	8-7
phasors	8-13
printing setpoints/actual values	8-9
requirements	8-1
startup	8-4
trending	8-10
troubleshooting	8-15
upgrade	8-2
upgrading firmware	8-6
upgrading setpoint files	8-9
SPECIFICATIONS	1-4
SPEED	5-16
STARTER	
information	4-7
operations	4-12
status	4-10
STATOR GROUND FAULT PROTECTION	B-1
STATUS LEDs	3-2, 3-3

T

TABLES	F-2
TACHOMETER	1-5, 4-14, 5-16
TEMPERATURE	5-15
TEMPERATURE DISPLAY	4-4
TERMINAL LAYOUT	2-5
TERMINAL LIST	2-6
TERMINAL LOCATIONS	2-5
TERMINAL SPECIFICATIONS	1-5
TEST ANALOG OUTPUT	4-76
TEST INPUT	4-12
TEST OUTPUT RELAYS	4-75
TESTS	
differential current accuracy	7-4
ground current accuracy	7-4, 7-13
list	7-1
negative-sequence current accuracy	7-5
neutral current accuracy	7-4
neutral voltage accuracy	7-4, 7-13
output current accuracy	7-3
output relays	7-8
overload curves	7-9
phase current accuracy	7-3
power measurement	7-10
production tests	1-8
reactive power	7-11
RTD accuracy	7-6
secondary injection setup	7-2
voltage input accuracy	7-3
voltage phase reversal	7-12
THERMAL CAPACITY USED	5-2
THERMAL ELEMENTS	4-64
THERMAL MODEL	
machine cooling	4-62
setpoints	4-51
specifications	1-7
unbalance bias	4-61
THERMAL RESET	4-12
THIRD HARMONIC VOLTAGE	B-6
TIME	4-5, 5-11

TIME OVERCURRENT CURVES	C-1
TIMERS	5-21
TIMING	6-3
TOC CHARACTERISTICS	4-17
TRACE MEMORY	6-10
TRENDING	8-10
TRIP COIL MONITOR	4-65
TRIP COIL SUPERVISION	1-4, 7-7
TRIP COUNTER	4-7, 4-65, 5-19
TRIP PICKUPS	5-5
TRIP RELAY	2-13, 4-16
TRIP TIME ON OVERLOAD, ESTIMATED	5-2
TRIPS	4-1
TYPE TESTS	1-8
TYPICAL WIRING DIAGRAM	2-7

U

UNBALANCE BIAS	4-61
UNDERFREQUENCY	4-33
UNDERVOLTAGE	1-6, 4-29
USER DEFINABLE MEMORY MAP	6-9

V

VIBRATION	2-11
VOLTAGE DEPENDENT OVERLOAD CURVE	4-57
VOLTAGE INPUT ACCURACY TEST	7-3
VOLTAGE INPUTS	
description	2-11
specifications	1-4
VOLTAGE METERING	5-13
VOLTAGE RESTRAINED OVERCURRENT	4-22
VOLTAGE RESTRAINED OVERCURRENT TEST	7-16
VOLTAGE SENSING	4-8
VOLTS/HERTZ	4-31
VT FUSE FAILURE	4-66
VT RATIO	4-8
VTFF	4-66
VTs	
open delta	4-37
setpoints	4-8
wye connected	4-37

W

WARRANTY	E-1
WAVEFORM CAPTURE	4-15, 6-10, 8-12
WIRING DIAGRAM	2-8
WITHDRAWAL	2-3
WYE	2-11
WYE CONNECTED VTs	4-37